

SEPTEMBER 1980

\$3.00

BMIE

BROADCAST MANAGEMENT/ENGINEERING



THE SOURCE: BUYER'S GUIDE

**TO THE
BROADCAST
INDUSTRY**

AUDIO EQUIPMENT/ VIDEO EQUIPMENT/ FILM
EQUIPMENT/ SET DESIGN/ RF TRANSMITTING
LIGHTING/ ANTENNAS/ TOWERS/ RECEIVING
EQUIPMENT/ TRANSMISSION LINES/SERVICES
MONITORING/ TIMING/ LOGGING EQUIPMENT/

MAGW0013853-XM-2801 CG1H
JOHN A WEYRICK OC X
MAGNETIX
5761-A KINGSGAIE DR
ORLANDO
FL 32809
-AD
**
**

2852 W. Harwood Ave
Orlando FL 32805



Camera shown with optional 12:1 zoom lens.

Introducing 4,551 reasons to buy the Panasonic AK-750B three-tube Plumbicon® camera.

The first 4,550 reasons to buy the Panasonic AK-750B are the 4,550 dollars we've shaved off the price of last year's comparably equipped model. The other big reason is 2-line enhancement—a \$2,000 option last year, but included as standard equipment at this year's low \$16,000* price. Other standard features include genlock, rechargeable battery and charger, microphone, and VTR cable.

At the heart of the AK-750B are three 2/3" Plumbicon tubes in parallel for great sensitivity over lighting extremes, superior static and dynamic resolution, and low burn-in.

Inside the AK-750B you'll find a durable aluminum die-

cast chassis and an impressive list of features like a Y I/Q encoder, color bar generator, and optical black and automatic white balance. There's also electronic color conversion, and a filter wheel behind the lens so you can make the most of both indoor and outdoor lighting. Plus adjustable horizontal and vertical blanking to fit a variety of recording requirements.

For the field, the AK-750B is a fully self-contained camera with timing and phase adjustments built in, but weighing in at only 16 lbs. (not including lens). And it's just as light on power, using only 23 watts. The camera comes with a C-mount adapter. And it can interface with an EFP system because

it accepts single-cable external sync.

The AK-750B can also be used as a studio camera with our optional Remote Control Unit and 4.5" CRT viewfinder.



Optional studio configuration.

But whether you're indoors or out, the AK-750B performs superbly with a S/N ratio of 50dB, and horizontal resolution is 500 lines at center (recommended illumination of 200 footcandles at f/4). There's even a +6dB gain for minimum illumination of just 15 footcandles at f/1.8.

The AK-750B. Because only Panasonic gives you so many reasons to buy a three-tube Plumbicon camera.

*Panasonic recommended price, but actual price will be set by dealers.

Plumbicon is a registered trademark of N.V. Philips of Holland for TV camera tubes.

For more information, write: Panasonic Company, Video Systems Division, One Panasonic Way, Secaucus, N.J. 07094. In Canada, Panasonic Video Systems Department, Mississauga, Ontario.

Panasonic
VIDEO SYSTEMS DIVISION

Circle 101 on Reader Service Card

Three more reasons for ADDA's leadership in digital image technology.



The VIP-2... affordable video compression.

ADDA delivers low cost video compression, featuring one-hand joystick operation and pre-programmed picture sizing and positioning. The selectable "zoom" mode features fixed picture center or fixed picture edge.



The VW-2... TBC/Frame Synchronizer for Type C VTR's.

The VW-2 is designed for Type C format VTR's, with time base correction and digital dropout compensation. Other features of the VW-2 include velocity correction, heterodyne time base correction, freeze frame, and freeze field.



Computerized Library Control for ESP Systems.

ADDA's new computer-directed library control system records the description and location of as many as 64,000 stills stored in the ESP System. It provides the off-line capability to preview stills, assemble and edit sequences through the use of subject, time, and program source codes.

ADDA CORPORATION

1671 Dell Avenue, Campbell, California 95008 (408) 379-1500

Circle 102 on Reader Service Card

The Inside Story of Hitachi's "Camera- Within-a-Camera"

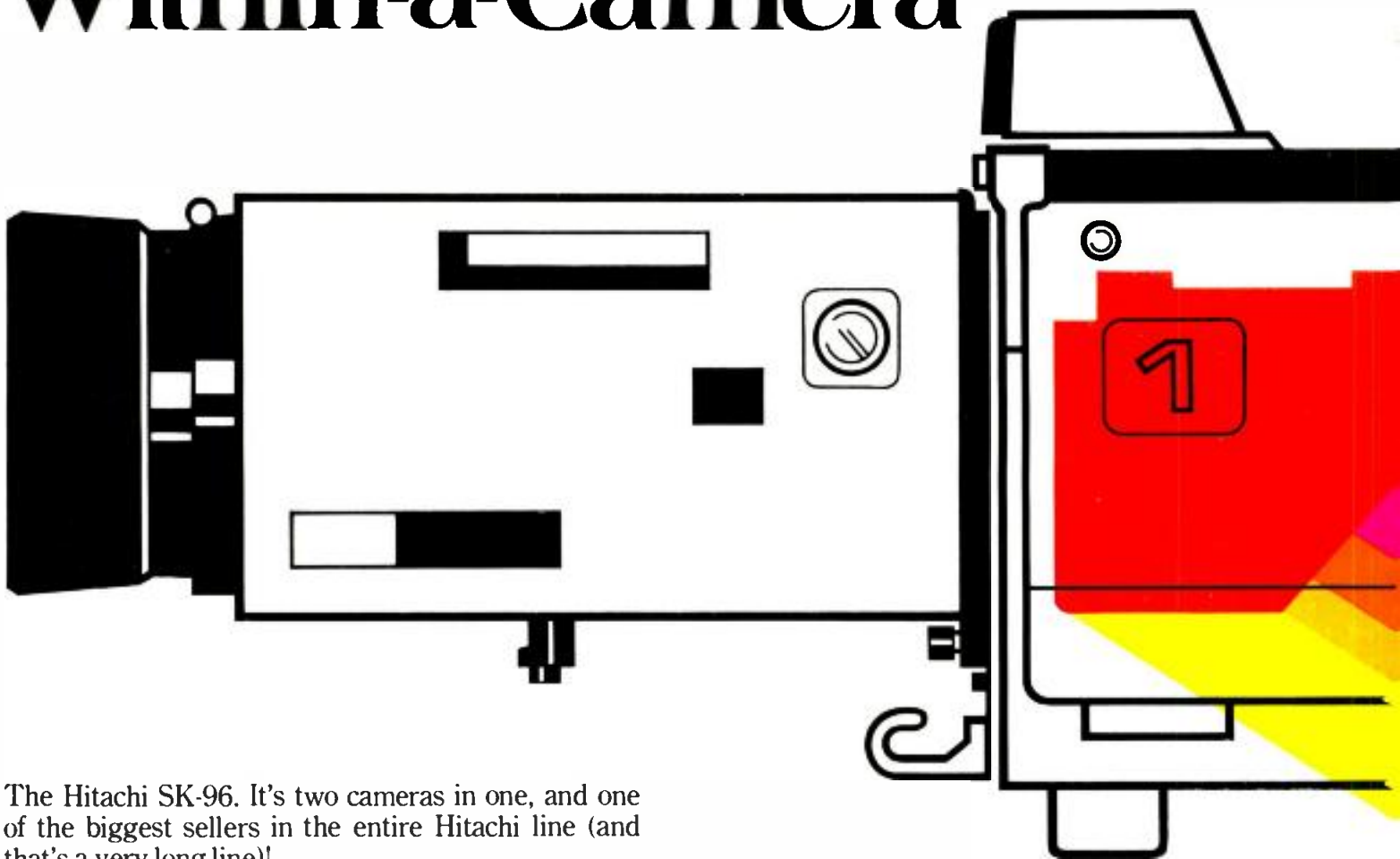

The Hitachi SK-96. It's two cameras in one, and one of the biggest sellers in the entire Hitachi line (and that's a very long line)!

Why? Two very good reasons: the studio SK-96 and the field SK-96 that's inside it. And though owning the SK-96 is like having two cameras, the cost is more like one. And picture quality is sensational, wherever you shoot.

The Studio SK-96

With the big 7" tiltable, rotatable viewfinder in place, the SK-96 is a knockout studio performer. Minimum performance levels of 550 lines and 54 dB assure you of the kind of superb image quality you expect of a studio camera.

The Field SK-96

Pull the compact head out of the studio housing, put on the 1-1/2" portable viewfinder with its 3" magnifier, and the SK-96 becomes a great field camera: compact, light, but loaded with Hitachi quality.

Indoors and out...

Wherever you're using the SK-96, the extras that make a camera airworthy are built-in: AC or 2-hour

DC pack, prism optics, a 2H enhancer, ABO, color bars, a wide choice of lenses, and your choice of three Saticon or Plumbicon tubes. A Digital Command Unit/triax option lets you shoot up to a mile from the van on remotes. It's a lot of quality and versatility for surprisingly little money. Get the inside and outside details...write.

Hitachi... Tomorrow's technology today.

9 Regional Centers for 24-Hour Parts and Field Service.
New York • Chicago • Los Angeles • Atlanta • Cincinnati
• Dallas • Denver • Seattle • Washington, D.C.



HITACHI

Hitachi Denshi America, Ltd.
175 Crossways Park West
Woodbury, N.Y. 11797
(516) 921-7200

Circle 103 on Reader Service Card



SK-96



BM/E

BROADCAST MANAGEMENT/ENGINEERING

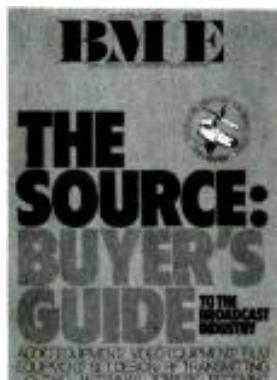

Reliable supplier is almost as important as a reliable product. BM/E's editors have compiled the industry's only verified buyer's guide to broadcast products and suppliers to help you find what you need to serve your audience with confidence

Publisher
Charles C. Lenz, Jr.
Editorial Director
James A. Lippke

Editor
David Hawthorne
Senior Editor
Robin Lanier
Associate Editor
Alex Londres
News Editor
Eva J. Blinder
Editorial Assistant
Doug Damoth

Assistant Publisher
Djuna Van Vort
Creative Director
Gus Sauter
Marketing Services Manager
Christine Bunish
Production Manager
David Rose
Advertising Production
Deborah Foley
Editorial Production
Heidi DeVos
Reader Service
Randy Applebaum

Comptroller
Alvin Ziluck

FCC Counsel
**Lovett Ford and
Hennessey, P.C.**

SEPTEMBER 1980/VOLUME 16/NUMBER 9

8 Broadcast Industry News

FCC unleashes cable TV; Idaho newsroom searched, tapes seized; Cablers set for Satcom III

18 Radio Programming & Production For Profit

Classical: small but solid

21 BM/E's Program Marketplace

Profile of Master Broadcast Services

25 Television Programming & Production For Profit

Small market craftsmanship: two award-winning documentaries show how

31 Live! From Atlanta — It's Cable News Network

Ted Turner aims to change cable's image

39 Moving Into The Audio 80s With The RKO Radio Net

RKO put audio quality and programming at the top

47 CCD Cameras: Coupled With The Future

TV may have to wait for a broadcast-quality model

52 THE SOURCE

52 Instant Source Locator

Nine categories —almost 400 subcategories —of broadcast equipment and who makes it

73 Broadcast Equipment Manufacturers

Names, addresses, telephone numbers, and product descriptions for hundreds of manufacturers. It's verified!

159 Independent Broadcast Reps/Distributors

All major reps/distributors organized by state

195 FCC Rules & Regulations

FCC eliminates major cable TV rules

198 Broadcast Equipment

BM/E's survey of new products

BROADBAND INFORMATION SERVICES, INC.
295 Madison Ave., New York, N.Y. 10017, 212-685-5320, Telex 644-001
Publishers of **BM/E—Broadcast Management/Engineering**
BM/E's World Broadcast News



VBPA BM/E BROADCAST MANAGEMENT ENGINEERING (USPS 059280) is published monthly by Broadband Information Services Inc. All notices pertaining to undeliverable mail or subscriptions should be addressed to 295 Madison Ave., New York, NY 10017. BM/E is circulated without charge to those responsible for station operation and for specifying and authorizing the purchase of equipment used in broadcast facilities in the U.S. and Canada. These facilities include AM, FM and TV broadcast stations, CATV systems, ETV stations, networks and studios, audio and video recording studios, consultants, etc. Subscription prices to others \$24.00 one year, \$36.00 two years, Foreign \$30.00 one year, \$48.00 two years. Air Mail rates on request. Copyright 1980 by Broadband Information Services, Inc., New York City. Controlled circulation postage paid at East Stroudsburg, PA.

World leader in television switching, signal processing, and distribution systems

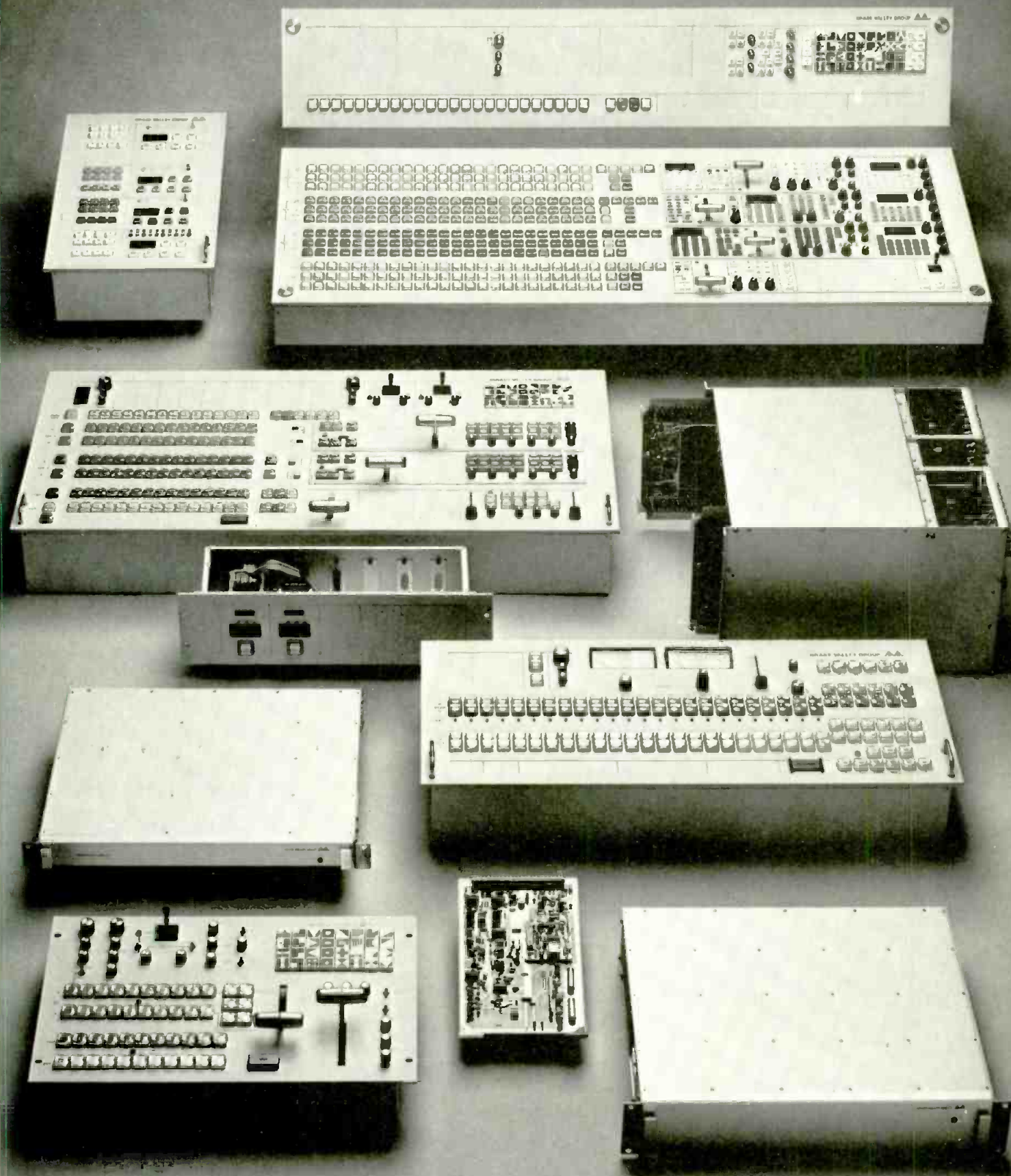

THE GRASS VALLEY GROUP, INC.®

P.O. BOX 1114 GRASS VALLEY CALIFORNIA 95945 USA • TEL: (916) 273-8421 TWX: 910-530-8280

A TEKTRONIX COMPANY

Offices: WEST; 21243 Ventura Blvd Ste 206, Woodland Hills, CA 91364 (213) 999-2303 • SOUTHEAST; 1644 Tullie Cir NE, Atlanta, GA 30329 (404) 321-4318 • NORTH CENTRAL; 810 W Bristol St, Elkhart, IN 46514 (219) 264-0931 • NEW ENGLAND & MID ATLANTIC; Station Plaza East, Great Neck, NY 11021 (516) 487-1311 • SOUTH-WEST; Seminary South Office Building Ste 316, Fort Worth, TX 76115, (817) 921-9411 • MIDWEST; 3585 N Lexington Ave Ste 238, Arden Hills, MN 55112 (612) 483-2594

Circle 104 on Reader Service Card

www.americanradiohistory.com

BROADCAST INDUSTRY NEWS

TV Ad Prices Rising In 1981

Advertising rates for nighttime network television will rise 10.7 percent in 1981, the largest rate increase in ad media, according to predictions made by *Marketing & Media Decisions* in its August issue.

While all media prices will be up, the forecasters see the largest cost-per-thousand rate increases in nighttime network advertising followed by daily newspapers (9.7 percent), daytime nets (8.7 percent), network radio (8.7 percent), spot radio (7.8 percent), and spot TV (7.4 percent).

Cablers Set For Satcom III-R

The new satellite replacing Satcom III, to be launched next June, will carry CNN, Warner Amex, and Times Mirror on Cable Net One.

An out-of-court settlement and a lottery determined who got the final spots on the 24-transponder bird, Satcom III-R. RCA Americom, operator of the Satcom system, held the lottery in New York to determine which of nine cablers would be allowed to climb on board.

The actual winners of the lottery were Warner Amex and United Video. United Video sold its rights to the transponder to Times Mirror last February.

CNN's satellite carrier agreed not to participate in the lottery in a deal with RCA. Ted Turner, owner of CNN, sued RCA for breach of contract after Satcom III was lost in space. Turner agreed to drop the suit in exchange for service on Cable Net One for three years. The

deal must be approved by the FCC.

The Commission has denied petitions by EMI, HBO, and Spanish International Network against the lottery procedure.

Spots on Cable Net One are far more valuable than those on Cable Net Two. Presently Net Two is carried on 11 leased transponders on Comstar III. Few cable systems have earth stations to receive both. RCA had planned to keep two transponders on Satcom III-R for reserved use, but is letting Southern Satellite Systems, Turner's carrier, use one when the bird goes up next year.

Pay Cable Venture Called Illegal

The Justice Department is charging four of the country's largest film companies and the Getty Oil Company with violating antitrust laws.

The suit, filed in Southern District Court in New York, names Columbia Pictures, MCA, Inc., Paramount Pictures, 20th Century Fox, and Getty. Their joint venture, Premiere, has been planning to offer first-run feature films for cable subscribers.

The four film companies and Getty are being charged with restraining free competition in the cable market by agreeing not to license their films to other pay TV networks for nine months after being made available to Premiere. The complaint also charges that the agreement would eliminate price competition for films.

The largest competitor of existing pay cable networks, Home Box Office, has been able to command films from studios at very low prices and has been

charged by competitors with monopolistic practices. The Justice Department has been watching HBO but has not yet taken any action.

The National Cable Association has expressed doubts about the legality of the Premiere venture, which still plans to start up in January. Even if Premiere is ruled an illegal partnership, losses are seen as small. The film companies can recover losses by selling films to other cable networks.

Idaho Newsroom Searched, Tapes Seized

What is believed to be the first search and seizure at a TV station's newsroom since the U.S. Supreme Court upheld the search of the *Stanford Daily* in 1978 recently took place at KCBI-TV, a CBS affiliate in Boise, Idaho.

Acting on a search warrant issued by a local magistrate, a team of seven plainclothes law officers swept through and searched the station, seizing copies of unedited news videotapes shot inside the Idaho State Penitentiary during a riot.

The act brings to question the rights of broadcasting stations as third parties in criminal investigations. KCBI-TV had refused to turn over the tapes earlier and tried to get a court restraining order. According to the station's attorney, however, there was no time to take the matter to the Idaho Supreme Court before the search warrant was issued.

"I feel that this is a clear infringement of our First Amendment rights," Paul Reiss, the station's news director, told law officers. "Seeing as how we have no legal recourse, I suppose I have to let you in."

TV For The Deaf Debuts

The National Captioning Institute has presented the world's first integrated closed-captioning TV set to the National Association of the Deaf before several thousand hearing-impaired men and women at the NAD convention in Cincinnati. The 19-inch "TeleCaption" color TV is sold exclusively by Sears, Roebuck & Co. and contains built-in decoding circuitry that allows printed captions or subtitles to appear on the screen.

NCI captions shows for ABC, NBC, and PBS television. Last March, NCI began closed-captioning 16 hours of



"TeleCaption" TV has a built-in decoding device. The TVs are sold exclusively by Sears

weekly programming. At present, 19 hours of closed-captioned programs are broadcast each week. A TeleCaption adapter unit which attaches to any TV set is also available through Sears.

NCI has entered the television syndication market with the first syndicated series to be closed-captioned. Robert Shuller's *Hour of Power* is a nationally televised program of religious services broadcast from Garden Grove, Calif. every Sunday. NCI was founded last year to provide captioning for the nation's 14 million hearing-impaired viewers.

Embarrassing questions to ask audio console salespeople

Sometimes it pays to ask questions. If the subject is audio consoles, asking difficult questions can be very revealing in comparing one console to another. Here are some of the questions that make most console salespeople squirm.

Is the console “human engineered”? Does the console have an esthetically “professional” appearance? Is the layout well defined and uncluttered? Are controls large? Do they fit the hand? Are they well labelled and lighted? Do they provide adequate visual feedback to affirm the position of the control? Is console nomenclature permanently engraved?

Easy to service? Are all components readily accessible and isolated for individual servicing? Are op-amps in plug-in sockets? Are there service loops in the wiring harness? Are extender boards provided? Are all wires uniquely numbered and referenced to your system documentation?

How responsive is the service department? Can they provide a history of fast, efficient customer service? Are they confident enough to furnish a complete list of customers for you to call?

How easy is installation? Is the console completely assembled and ready to install? Are installation points readily accessible? Are all program inputs and outputs uniquely transformer isolated?

How about specifications? Are the manufacturers’ published specifications consistent and easily understandable or mired in the game called “specsmanship”?

How good is reliability? Do all modules receive three levels of testing? Does the total system receive 4 levels of performance verification? Do both the modules and system receive extensive burn-in?

Is the console backed by a 5-year, all-inclusive warranty? (Only ADM answers “yes” to that one.) ADM and only ADM answers all of these questions with a full, no weaseling, resounding “YES”! The only question remaining is, when would you like to talk to us about a new audio console?

For facts about our Series 3200, 2400, 1600, or 800 ADM Audio Consoles, contact ADM Technology, Inc., 16005 Sturgeon, Roseville, Michigan 48066. Phone (313) 778-8400. TLX 23-1114.



ADM 1600
Audio Console
—Modest
but mighty.

ADM[®] The
Audio
Company

News

Reiss said the station would be glad to let authorities subpoena the tapes after they were edited and presented on the air.

Desks and film cabinets were searched for 90 minutes until two one-hour videotape cassettes, labeled as pertaining to the riot, were found on a shelf in the film library. Station personnel did not interfere with the searchers. James Harris, Ada County's prosecuting attorney, said he would file charges

of tampering with evidence if the seized tapes were different from the originals. Two days later he said he had reason to believe the tapes were altered.

Although several states have passed legislation protecting news organizations from such searches, Idaho has not. The House and Senate Judiciary Committees have approved legislation intended to restrict police searches aimed at "third parties" and requiring subpoenas in most cases, but none has reached a floor vote.

No subpoena for the tapes was sought by prosecutors in the Boise ac-

tion, a move the station could have contested.

KCBI's managing editor, Bob Loy, who made the tapes, said much of the material was confidential. The tapes were made by him and a cameraman, Mark Montgomery, in the early hours of the prison outbreak. Both were admitted to the prison at the request of inmates, who held control of the prison overnight until a riot squad and National Guardsmen stormed the facility. The tapes were sought in order to identify leaders of the riot.

Of the search and seizure, Loy said, "When I saw them going through my desk, I saw my freedoms evaporate."

Case History #437

Electronic News Gathering is one of the toughest environments a microphone will ever encounter. Every mike we've seen has com-

promised the demand for low handling noise, fine audio quality and virtual indestructibility.

Credit the NBC Electronic Journalism Department/Operations and Engineering in New York for putting the Electro-Voice DO56 shock-mounted omni in the field. Although originally designed as an on-camera entertainment and MC's microphone, NBC found the DO56 to be the microphone that provides an audio signal commensurate with video in real-life crisis situations. In these situations audio often takes a back seat to video,

Electro-Voice DO56 Shock-Mounted Omnidirectional Microphone

pushes, the shoves, the rubs and finger taps in stride. And when handling *really* gets rough, the DO56's unique internal shock mount virtually eliminates the bell-like clang transmitted by other shock-mounted mikes.

Congratulations to the NBC Electronic Journalism Department in New York. You found the solution — the DO56.

For an in-depth description of this and other case histories, get on the Electro-Voice "Mike Facts" mailing list. Write on your letterhead to Mike Facts, c/o Electro-Voice, 600 Cecil Street, Buchanan, MI 49107.

resulting in a final product that doesn't accurately reflect the broadcaster's professional standards. NBC discovered that the DO56 takes the

 **Electro-Voice**
a gulton company



Circle 106 on Reader Service Card

FCC Unleashes Cable TV

In a broad move that opens up the television industry to further competition, the FCC has eliminated two major regulations that have restricted cable programming since 1972. By a four to three vote, the Commission has allowed cable systems to carry the same programs presented by local stations, and has authorized cable operators to carry as many stations from outside their franchise areas as they or their viewers want.

The elimination of the blackout rule and the distant signal importation rule reverses a long-standing policy that has protected the broadcast industry from inroads made by cable operations.

The National Association of Broadcasters has called the decision "irresponsible" and a network spokesman says the vote was a "step backward for the viewing public."

The FCC move comes after a three-year investigation concluding that consumers would benefit from the deregulation. Although the study was not involved with the economic effects on cable systems, the Commission's staff found that in all but unusual cases, broadcasters would lose less than 10 percent of their audiences.

"Cable has not, and will not, destroy broadcasting as was once feared," said Charles D. Ferris, chairman of the FCC. "Broadcasting profits have continued to grow at a fast pace, despite cable's rapid expansion."

As expected, the blackout rule — which forces cable operators to blackout programs considered property of local stations — was the most controversial of the issues.

Distant signals, those coming from more than 35 miles away in large markets and 55 miles away in smaller markets, can now be brought into an area without limitations. The decision to let cable systems bring in distant programming means viewers in nonmetropolitan areas can get the programming offered in the major markets.

TV STEREO SOUND FOR THE 1980's?

If you're serious about TV stereo sound, Neve's got more models of TV audio consoles with stereo production facilities than anyone else, from small mixers to large consoles. Model 5316 features stereo pan to submasters and to stereo PGM and AUD outputs. We're even providing stereo cue (solo) on this comprehensive TV sound production console! The availability of 24 or 36 channel positions, 8 submasters, 4 masters, patch optional left or right, choice of equalization and much more, makes the 5316 the ideal audio console for larger TV stations. And delivery is generally stock to 90 days! TV stereo sound or not, discuss your audio console requirement with Neve. We're in your future!



 **Neve**

Rupert Neve Incorporated Berkshire Industrial Park, Bethel, Connecticut 06801 Tel: (203)744-6230 Telex: 969638
Rupert Neve Incorporated 7533 Sunset Blvd., Hollywood, California 90046 Tel: (213)874-8124 Telex: 194942
Rupert Neve of Canada, Ltd. 2721 Rena Road, Malton, Ontario L4T 3K1, Canada Tel: (416)677-6611 Telex: 983502
Neve Electronics International, Ltd. Cambridge House, Melbourn, Royston, Hertfordshire, SG8 6AU England Tel: (0763)60776
Rupert Neve GmbH 6100 Darmstadt Bismarckstrasse 114, West Germany Tel: (06151)81764
Circle 107 on Reader Service Card

News

Under a plan adopted by Congress in 1976, cable systems must pay a small percentage of their revenues to the Copyright Royalty Tribunal, which divides the money among a number of parties including public and private television and the movie industry. The Motion Picture Association of America, whose members supply much of the programming to television networks, has called the Commission's move a "detriment" to those "who can

neither afford pay cable nor have access to it."

In response, the Malrite Broadcasting Corporation has filed the first notice of intent to appeal the FCC decision. Malrite owns WUHF-TV in Rochester and holds construction permits for independent TV stations in Florida. While it appears certain the matter will come before Congress, no action appears likely during the current session.

Network programming still remains protected by FCC regulations, but the ruling broadens the possibilities of

cable programming. Still in effect are other restrictions on cable systems including the sports blackout rule, requiring cable systems to black out a live sports program at the request of officials if local attendance is not sold out.

The FCC still is planning to further deregulate the cable industry.

Performers On Strike

Actors and actresses are striking the movie and television industry for what they claim is their fair share of industry profits — especially income from the cable and home video markets.

Some 60,000 members of the Screen Actors Guild and the American Federation of Television and Radio Artists have virtually shut down the production of feature films and prime-time television programming.

TV stars Ed Asner and Michael Landon have joined bit players and some of the union's highest paid artists such as Barbra Streisand, Burt Reynolds, and Jack Nicholson in refusing to work.

The major issues in the strike include a 35 percent increase over three years in the minimum scale plus demands for a share of profits from the sale of films for television, cable services, and home video.

In the weeks leading up to the current strike, union leaders have cited "Hollywoodgate" scandals to support their claims that "creative accounting" was cutting members out of a fair share of profits. (Three years ago, David Begelman, a senior exec at Columbia Pictures, was fired for allegedly forging studio checks. More recently, allegations have been made against Spelling-Goldberg Productions, a major TV program supplier, that Robert Wagner and Natalie Wood were cheated out of profits from the series *Charlie's Angels* with the tacit approval of ABC.)

The studios and the networks deny that performers aren't getting their fair share, saying that so far, new video markets do not generate much income.

The unions claim they have stopped production on 11 feature films and at least 45 television series. So far, both sides of the dispute have not reached an agreement and network officials say this could delay the start of the fall television season.

SAG walked out in 1960 when Ronald Reagan was its head.

Errata In June

Through an oversight, the acquisition of Videomax was attributed to the wrong company in our NAB Show-In-Print issue. Videomax, a division of Orrox Corp., was acquired by CMC Technology of Sunnyvale, Calif., in October, 1979.

Now you really can sound *good* and *loud*!

NEW MSP-90 TRI-BAND AGC AMP PROTECTS YOUR AUDIO QUALITY WHILE SIGNIFICANTLY INCREASING LOUDNESS



Today's listeners are more discriminating, and "loudness without quality" audio is not acceptable to most audiences over the long term. The Harris MSP-90 Tri-Band AGC Amplifier has been designed with this in mind—and introduces a new type of processing that makes you sound not just loud, but *good* and loud.

The Harris Tri-Band AGC uses true RMS power sensing (vs. the typical peak or average sensing of competitive models), and coherent filtering that is bandsplit so precisely that it may be summed without error. The result is a cleaner, more dynamic sound.

In addition, the Harris Tri-Band AGC has adjustable turnover frequencies, ± 10 dB level adjustment of three bands with front panel controls, dynamic program dependent attack time—plus many other features not found in competitive AGC amplifiers.

This is the one unit that further refines the AGC concept to provide a performance level far beyond anything previously available. For more information on the new Harris Tri-Band AGC write or call Harris Corporation, P.O. Box 4290, Quincy, IL 62301, 217-222-8200.

Visit the Harris Display
at the 1980 NRBA,
Los Angeles



HARRIS
COMMUNICATION AND
INFORMATION PROCESSING

Circle 108 on Reader Service Card

All Similarity Between A Live Performance and

BARCO MONITORS

Is Purely Intentional!

With Barco, reliability is more than a word, it's a commitment . . . backed by the most comprehensive customer support program in the industry. If you ever need service, our factory trained engineers are on hand 24 hours a day. If you need a part, we'll ship it out the same day you call, because they're all in stock. Of course, with Barco, you get the best professional color monitor

money can buy... at a competitive price... and they are **IN STOCK — SHIPPED THE SAME DAY YCU ORDER.** Today, more than ever before, you need the total Customer Support Program that only Rohde & Schwarz offers.

Contact us at 14 Gloria Lane, Fairfield, NJ 07006 or call (201) 575-0750. Telex 133310.

ROHDE & SCHWARZ SALES CO. (U.S.A.) INC.

Sole representative for Barco Professional Video Systems Dept. in the United States.



News Briefs

The FCC retreated from making a final decision on an AM stereo system, calling for further notice of rulemaking and leaving its tentative choice of Magnavox in question. A revised evaluation matrix will be released officially this month. Leonard Kahn of Kahn Communications claims to have a network radio commitment if the "market-place" approach is approved. Magnavox has announced a procedure that would convert Kahn exciter signals to

Magnavox's.

GalaVision, the Spanish-language pay TV service, and Spanish International Network have merged into SIN, Inc. Seventy-five percent of the company is owned by Televisa, S.A. . . . Fairchild and Continental Telephone Corp. have announced plans to form a partnership, American Satellite Company.

Even without the Olympics, all three major networks (ABC, CBS, and NBC) say their prime-time selling for 1980-1981 will near the \$1.6 billion mark of last year . . . The FCC has released

financial data for the three networks and their 15 O&O stations showing that 1979 revenues were up from the previous year and operation profits down. A sampling of eight national radio networks, including MBS, showed a 6.6 percent increase in revenue for 1978-79, but a 15 percent drop in profits.

Massachusetts has dropped rate-setting controls on cable television companies except where reception and competition are inadequate . . . The Society of Broadcast Engineers' fall 1980 certification exams will be given November 17 through December 8. Applications must be received by October 6. Requests should be sent to SBE Certification Secretary, P.O. Box 50844, Indianapolis, Ind. 46250.

Unattended Transmitter Monitor, Alarm & Control

Model 5003

Installed at remote transmitter locations. Direct connection to public telephone network, leased lines, two-way radio or microwave network. Feeds data to Model 5004.

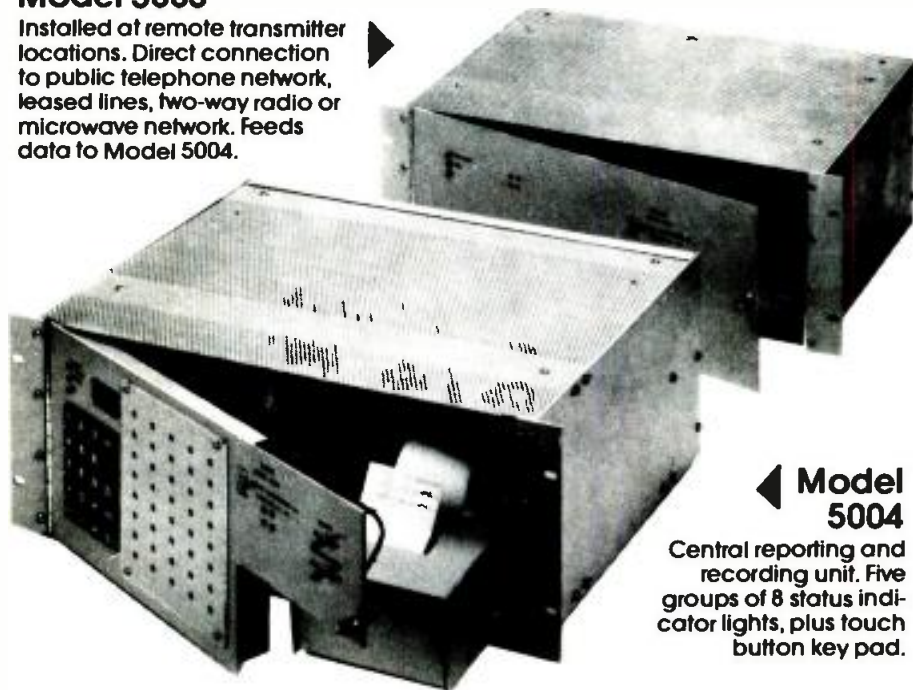

Model 5004

Central reporting and recording unit. Five groups of 8 status indicator lights, plus touch button key pad.

Remote Supervisory Model 5003

Capable of monitoring and controlling up to 5 transmitters at one remote site plus building status. It connects directly to dial-up public telephone, radio, or microwave. Stand by battery power supply is standard.

Central Model 5004

Displays the status of (8 to 48) remote contacts and has the hard copy data logger to provide the permanent record of time of day, date and status.

These two units can be equipped to provide building security with recordings to notify local security forces.

Send for full color, 4-page brochure.



MONROE ELECTRONICS, INC.

212 Housel Avenue Lyndonville NY 14098
Phone: (716) 765-2254

Business Briefs

RCA indicates a second quarter drop of 9.9 percent in net income for their second quarter, due in part to NBC's \$16.1 million dollar loss from the Olympic boycott . . . Scientific-Atlanta expects a record gain of 68 percent in sales, earnings, and new orders for fiscal 1980. American Satellite plans to buy \$7.5 to \$15 million of digital earth stations from the company.

Taft Broadcasting is showing nearly a 10 percent drop in earnings for fiscal first quarter: revenues were up 7.5 percent . . . Ampex Corporation is announcing record earnings for fiscal 1980 which are up 34 percent over last year.

WPDE-TV, a new station in Florence, S.C., will go on the air this fall with \$1.5 of RCA TV studio and transmitting equipment . . . KSL-TV, Salt Lake City, is adding eight RCA TK-47 cameras to its operations, three of which are for mobile units . . . WTVQ, Lexington, Ky., is adding a new RCA TV transmitter and antenna worth \$1 million for its new channel assignment.

NET Mobile Video Services of Ann Arbor has bought a \$2 million video remote unit from Compact Video Systems, Calif. . . . The Copyright Royalty Tribunal has issued a plan to divide \$14.6 million in royalties paid by cable companies in 1978. U.S. and Canadian broadcasters will split 3.25 percent, PBS will get five percent, and program syndicators 75 percent. The rest goes to sports programmers, music performing rights societies, and National Public Radio.

Avab America has moved to 329 Oser Avenue, Hauppauge, N.Y. . . . Hitachi Denshi America has opened new offices in Lanham, Md. and Cincinnati, Ohio . . . James G. Cronin has been named client service rep, Arbitron television station sales.

Circle 110 on Reader Service Card

EYE-OPENERS

Just when everyone had their eyes wide open to the outstanding line of Ikegami broadcast and production color cameras, Ikegami introduced its color and B&W monitor line, engineered with the same innovative technology as its cameras. A great tradition of eye-opening continues with precision, quality and beautiful images.

The Ikegami color monitor line consists of the High Resolution Series RH Color Monitors and the High Performance Series 8 Color Monitors. The High Resolution Series RH Color Monitors are available in the 14" TM 14-2RHA and the 20" TM 20-8RH. Both provide precision color reproduction at 600 plus lines for professional studios, control rooms, remote vans, etc., and feature a high resolution CRT with High Density Dot Matrix, a switchable comb filter in the decoder, and the AFPC (Automatic Frequency Phase Control) system to maintain exceptional color reproduction. Both models are rack-mountable, with the TM

14-2RHA featuring plug-in circuit boards for easy maintenance.

The High Performance Series 8 Color Monitors are available in the 14" TM14-8RC, 20" TM20-8R and 25" TM25-8. The Series 8 monitors offer high quality color reproduction, a Shadow Mask Dot Matrix CRT, Pulse Cross Circuit, Active Convergence Circuit, low power consumption, and more.

The B&W Monitors are engineered to the same exacting Ikegami standards and are available in Triple 5", Dual 9", 5", 9", 12", 17" and 20" sizes.

Ikegami's Eye-Openers are available at most dealers. For details and additional information, contact: Ikegami Electronics (USA) Inc., 37 Brook Ave., Maywood, NJ 07607, (201) 368-9171; West Coast: 19164 Van Ness Ave., Torrance, CA 90501, (213) 328-2814; Southwest: 330 North Belt East, Suite 228, Houston, TX 77060, (713) 445-0100; Southeast: 522 So. Lee St., Americus, GA 31709, (912) 924-0061.



Video Products built to Ideal Standards

 **Ikegami**

Circle 111 on Reader Service Card



The VPR-20 Edge. Total Performance in the Field.

Post-production in the field becomes an option when you take the VPR-20 on assignment. Its capabilities are so complete that you can return with a finished production.

Advanced Editing Technology. From Ampex, Of Course.

The intelligent design that went into our VPR-2B videotape recorder was also applied to our smart, rugged 1" portable.

For example, our exclusive dual-cue editing gives you studio-type control. Four edit-related functions give you the edge: From "let's see it" reviews, and precise returns to the next edit point, to total control when replacing undesired material, and even mid-segment edits to new material. All in one, easy to use portable.

The VPR-20 remembers through its exclusive tape timer and servo system, so your "cue-ups" are accurate and fast, and your edits are clean and color-frame accurate.

The VPR-20's performance continues with a video confidence feature that plays the picture back from the tape into the camera viewfinder during recording. You can use any color television receiver for playback. And thanks to our exclusive built-in color stabilizer, you can leave the time base corrector behind and still show full color in the field.

A Portable Should Be Portable.

The VPR-20 is. Even with non-battery use you'll be free of the burden of cumbersome additional equipment.

Unlike other portable recorders, the VPR-20 has a simple-to-use, plug-in AC power pack. It replaces the battery in our portable and allows you to forget the bulky external power supplies necessary with other portables.

The VPR-20 from Ampex. Total performance in a 1" portable videotape recorder.

Call your Ampex representative today. Tell him you're ready for the VPR-20 edge.

Get the Ampex Edge.



EXCLUSIVE DUAL-CUE EDITING

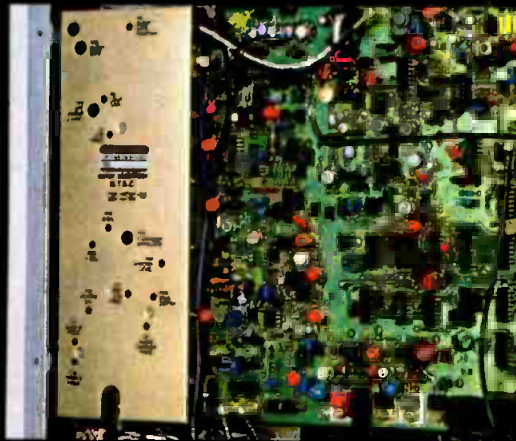

BUILT-IN COLOR STABILIZER



PLUG-IN AC POWER PACK



Ampex Corporation, Audio-Video Systems Division
401 Broadway, Redwood City, CA 94063
415/367-2011

Circle 112 on Reader Service Card

Comrex Makes Low Frequency Extenders

An audio must. Broadcast quality on a standard dial telephone line. For networking, "first & last mile" satellite delivery, news, sports, weather, farm, stock market, religious or special interest programs.

Cue Systems

The ideal way to direct ENG field personnel. A 1 watt IFB system that allows ENG crew to hear both program and instructions in one pocket receiver. ALSO - TV Aural Monitors. Rugged pocket receivers fix-tuned to your TV channel for live off-air cueing. 50-550 MHz.

Wireless Microphones

A new line of ENG gear.

Talk Show System

A studio/telephone interface system that permits on-air conferencing of two incoming telephone callers with studio host. The only complete, ready-to-go talk show system available.

For further information, call or write:

COMREX

18 Years in Broadcasting

P.O. Box 269

60 Union Avenue

Sudbury, Massachusetts 01776

TEL: (617)443-8811

TWX: 710 347-1049

RADIO

PROGRAMMING & PRODUCTION FOR PROFIT

Classical: Small But Solid

IT HAS BEEN A LONG TIME since the prevailing idea about classical music programming for radio was that, except for a half-dozen big-city locations, it constituted a short trip to bankruptcy. The industry knows from a number of examples that classical music can work in quite a few places. It takes hard work — but so does success with any format in today's radio market warfare.

The meeting in May of the Concert Music Broadcasters Association brought together information that shows classical programming is alive and growing. Growth in number of stations, growth in audiences, and growth in financial returns were all reported there. The number of stations, both commercial and noncommercial, using classical music as the sole or greater part of the format went up from 87 in 1973 to 235 in 1979. Seventy-six of them are commercial stations. When stations now using classical music for some appreciable part of their program time are added, the total rises to about 650.

The rise in total sales from 1978 to 1979 was sharp, amounting to 34 percent for about 30 stations surveyed at the meeting. Sales for radio as a whole rose eight percent from 1978 to 1979.

Behind the growth is a continuing refinement of knowledge about the classical listener and a rapid spread of this knowledge among large advertisers and advertising agencies. It has been established by a number of studies that the classical audience is greatly above the national average in income, education, and propensity to buy a long list of products and services. WFMT in Chicago, a leader in developing this information, has for several years distributed convincing statistics on the subject under the title "The Classical Advantage." WNCN in New York has also put the facts about the audience to excellent use in its marked success (see the March, 1978, issue for a story on WNCN). The same applies to long-established classical stations in Los Angeles, San Francisco, Boston, Cleveland, Washington, Philadelphia, and other cities.

Robert Richer, manager of WNCN, commented to *BM/E*: "With fractionation of radio audiences a strong trend, the classical station is lucky to have its own fraction, a highly salable one that will stay with the station." The fact that WNCN has made a strong success in New York alongside veteran WQXR,

itself an expanding business, shows the growing reserve power of the classical market.

Two other recent management decisions spring from the strength of classical programming. The Outlet Company of Providence, a large retail chain that has bought a number of radio and television stations (see December, 1979 *BM/E* for story on Outlet's reinvigoration of WTOP, Washington), has converted a recent purchase, WQRS in Detroit, into a classical station with new, state-of-the-art equipment throughout. The management is positioning the station in the public mind as an important element of the Detroit cultural "renaissance."

Another new fine arts station will be on the air in a year or so, this one in Tulsa, Okla., the project of Dr. John Major, who will leave his present post as director of marketing at WFMT to build and direct the new station.

Recent audience research has added important sales ammunition for classical station managements. For example, a new technique of the RAM organization divides the audience according to zip codes, which have been found to correlate strongly with income levels. In an "affluent" zip code area in Cleveland RAM found that WCLV, the classical station there, ranked number one among adults, with an 11.3 share over a significant six-month period. The management of WCLV reported this information to be highly persuasive as a sales tool.

The special "salability" of the classical audience has played a central role in a recent station success story, that of KCMS in Indio, Calif. P.M. Posen, president and general manager, told *BM/E* that he chose a 100 percent classical format when he started the station in November, 1977, because of the character of the audience. Palm Springs and the surrounding area, with about 100,000 people, is skewed heavily toward the wealthy, the retired affluent, the well-to-do vacationer. Many retail businesses in the area serve these people, naturally with a large proportion of luxury products.

Add the fact that the area is in a valley that cannot receive radio signals from the nearby metropolitan areas, Los Angeles and San Diego, and we see why a possible opportunity for a classical format presented itself. KCMS has made effective use of the opportunity, chalking up financial success from the

Circle 113 on Reader Service Card

CMC Technology Refurbishes More Kinds Of Video Heads In Half The Time. Guaranteed.

Type of head	Refurbished by CMCT	Turnaround Time*
Ampex Mark XX (Alfesil)	YES	10 days
Ampex Mark XX (Ferrite)	YES	10 days
Ampex Mark XV (Alfesil)	YES	10 days
Ampex Mark XV (Ferrite)	YES	10 days
Ampex Mark X (Alfesil)	YES	10 days
Ampex Mark X (Ferrite)	YES	10 days
RCA Highband (Alfesil)	YES	10 days
RCA Highband (Ferrite)	YES	10 days

*Time between date received by CMCT and date shipped from CMCT.

AT CMC Technology, refurbishing video head assemblies is all we do. So we have to do it better and faster than any other company.

CMC Technology refurbishes the widest variety of video head assemblies in the industry. That means we can give you unbiased advice on the type of head assembly you should use for best performance at the lowest cost per operating hour.

We also give you the fastest turnaround time in the industry: 10 days. Guaranteed.

Since 1973, we've supplied a major share of video heads to the major U.S. networks and production houses, the BBC, and The Australian Broadcasting Commission. These companies use CMC Technology because they demand the best quality and the fastest service. So should you.

The next time you need a video head assembly refurbished, try us. Call your nearest CMC Technology representative. We're ready to work for you.



CMC Technology Corporation
733 N. Pastoria Avenue
Sunnyvale, CA 94086 U.S.A.
Telephone: (408) 245-3342
Telex: 910-3970012

Futek, Incorporated
Tokyo, Japan
Telephone: 498-4733
Telex: 781-242-3456

Intergen Corporation Ltd.
Kowloon, Hong Kong
Telephone: 3-690-416
Telex: 780-84154

Premier Enterprises Ltd.
Islamabad, Pakistan
Telephone: 22484
Telex: 952-5945

Teknomerica, S.A.
Col. Las Aguilas, Mexico
Telephone: 593-2046
Telex: 383-177-7202

General Video Company Ltd.
Wellington, New Zealand
Telephone: 872-574
Telex: 791-3859

Maz-Systeme, E. Muller GmbH
Eppertshausen, West Germany
Telephone: 06071-33344
Telex: 841-419-1819

Quantum Electronics Pty. Ltd.
Mona Vale, Australia
Telephone: 997-4988
Telex: 790-26717

W. L. Kerr (Private) Ltd.
Salisbury, Zimbabwe
Telephone: 707601/3
Telex: 987-2343

Glentronix (1977) Ltd.
Toronto, Canada
Telephone: 444-8497
Telex: 06-986-741

Neotecnica, S.A.E.
Madrid, Spain
Telephone: 248-0900
Telex: 831-22099

Radiokom (1969) Pty. Ltd.
Pinegowrie, South Africa
Telephone: 789-1400
Telex: 960-42482

Distributor's Inquiries We comed

Circle 114 on Reader Service Card

Radio Programming

beginning. The original staff of three has expanded to 15 people; the station is booked nearly solid most of the time. Posen believes his market may be the smallest in the country that is supporting a 100-percent classical station.

Another recent research finding is surprising to many, and is also positive for many advertisers. A study by the Simmons Market Research Bureau, covering the period from April to July 1979, indicates that the classical/semi-classical audience skews much younger in age than most people have assumed in the past. The top demographic group among these listeners, in Simmons' findings, was 25 to 34 by a wide margin; listeners in that age group were 57 percent more likely than the average of all adults to listen regularly to this kind of music. All other age groups as ordinarily defined were below national averages in likelihood to be classical listeners.

There are other developments that are strongly positive for classical formats. Most important are the invasion of the industry by satellites and the formation by a number of organizations of satellite nets to supply affiliates with stereophonic concert music. Mutual, RKO, National Public Radio, and PBS will all be powerful in this area. The creation of "superstations" like WFMT by satellite-to-cable nets is another push for classical music.

The very fast growth of digital recording in the commercial record industry is technically aiding and abetting the classical station. In all these very important ways classical managements are getting better tools for the job and better sources of programming.

Further evidence of the strength of classical music programming came in *BM/E* interviews with Neil Currie of Parkway Productions and John Emery of WCRB, the two leading classical syndicators. Both testified that sales to radio stations are expanding. Currie attributed this in part to a new mood among advertisers, who are much more apt to target their buys to specific audiences than they used to be. "Today they ask first how much the ad will cost, then what *kind* of people it will reach, and only third comes the question about numbers," he said. "The numbers used to be everything."

John Emery said that sales of WCRB's Boston Symphony and Boston Pops series, both of which are paid for by the subscriber, are rising. He believes that the "upscale" demographic characteristics of classical listeners give them a measure of immunity to recession effects: no noticeable softness has developed in his business. He reported a feeling among music pro-



In studio at WNCN, the Concertino Quartet goes on the air with Mozart's "Dissonant Quartet," typical of live broadcasts that are increasing in number at classical stations. Members are (left to right) Erle Grubb, first, and Victoria Stark, second violins; Ira King, viola; and Mary Ann Campbell, cello. Two crossed mics are used in "coincident mic" stereo

gramming personnel at recent conferences that the supply of classical programming was becoming an embarrassment of riches, with a considerable number of syndication operations from such stations as WFMT, Chicago, WNCN, New York, and others, plus the music that will be coming more and more from the satellite networks. This plenitude of programming, Emery believes, can only expand the market.

He recently spotted another positive trend for this expansion: a growing tendency for stations not primarily classical in format to buy some classical music. The trend appeared most strongly in a study of subscribers to the Boston Pops, which is admittedly a kind of "cross-over" music. No less than 59 percent of current subscribers are not classical stations, Emery says.

This is, of course, strong evidence that the classical "market" is expanding, and also that station managements in general are getting bolder: they are willing to take a chance on some classical. To get a further understanding of why they do it, and how it is working out, *BM/E* interviewed several managements who use classical music as a small proportion of their programming.

In Boise, Idaho, KYME uses a mixture of jazz, big band music, opera, and classical: roughly 25 percent is classical. Station manager Stephen Oliver told *BM/E* that the area, with around 200,000 people, is intensely competitive for radio, receiving 22 strong signals. In a survey several years ago KYME discovered that the lack of serious music was noted by a sizeable number of respondents. The other stations were using one or another of the "popular" formats, such as Country, Rock, or Beautiful Music. This indicated a hole that KYME has filled.

Oliver emphasized, however, that it takes real understanding of the format and extremely hard work to make it go in such a market. KYME not only brings "big orchestra" symphony and opera from national centers, but also involves itself deeply in the community's own music. Local symphony and opera programs are taped and put on the air regularly. The local music has won strong support from local businesses that want a positive "community" image — several banks, for example.

Oliver also noted the essential part played by the upscale demographics of the audience. This, he said, has been decisive for many advertisers.

In Cape Coral, Fla., WRCC similarly programs a mixture of classical music with "memory music" — MOR, easy listening — plus big-band music. The situation is similar to that of KYME: a blank area on the classical map, with roughly 200,000 people in the metro market. R.W. Diederich, president and general manager, told *BM/E* that his "adventuresomeness" has paid off with a good volume of business from advertisers wanting to reach the upscale listener. The classical programs are consistently sold out; they amount to roughly 15 percent of total program time. Diederich's own boldness cannot be overlooked in this story: he also does some radio drama, the mark of a man who doesn't live by the record sales charts or other guides to mass taste.

We conclude that classical music on radio is doing much better than just hanging on to the five percent of the audience traditionally in the classical camp. Maybe we will have to revise that figure soon. It will never be a large figure, but it represents a very stable, very prosperous minority. **BM/E**

Syndicators: Where They Are Now

Master Broadcast Services, Inc.
P.O. Box 61
Morrisville, Penn. 19067
Tel.: (215) 295-0413

SINCE THIS DEPARTMENT STARTED in January, 1977, it has carried profiles of 40 syndicators for radio. As far as *BM/E* can determine only two of them have gone out of business in the meantime. Life expectancy in full-format syndication for radio thus appears to be better than it is in many lines of business. We certainly don't know the specific reasons for this. It could well be simply the expansionist period the business has been in, or the fact that it attracts especially competent, talented people, as *BM/E*'s contacts in the field indicate.

In any case we should be able to learn something from finding out what has happened to those we first visited two and three years ago. First on our list of revisits is Master Broadcast Services, profiled in July, 1977. The survival, indeed the steady growth, of Master Broadcast is interesting because the business was originally built on, and for several years depended on, the talent and energy of one person — its founder, Jason Taylor. He was an early exponent of "matched flow" Beautiful Music programming, and his success in attracting and holding a small but viable group of subscribers testified to his personal taste and skill in putting program material into sequences that please listeners.

Also essential to the health of the business has been Taylor's careful response to what he sees as a taste trend away from the old 100 percent "soaring strings" character of Beautiful Music. Listeners today, and particularly the younger listeners that Taylor insists on reaching, want music that is more "foreground," more representative of current new hits, than the old Beautiful Music formula allows.

Taylor's skill in this high art is attested by the growth of his subscriber list to 12 stations, including a number of outstanding market successes.

The business also reached a new enlarged phase recently with the addition of Loring Fisher as a partner. Fisher was for many years executive vice president of Bonneville Broadcast Consultants.

In a joint interview with *BM/E* Taylor and Fisher told how they plan to

make maximum use of their pool of skills. Although they are both young men, they have a combined 48 years of experience in radio programming and management — Taylor started in radio at 15, Fisher at 17.

They emphasize the fact that in today's competitive market a radio station cannot pull out of the heap by simply buying good programming and putting it on the tape machines at the appointed times. The management must understand exactly what the programming stands for, what listeners it will please, and what its strengths are with advertisers.

This implies a program of internal indoctrination and planning within the station management. The planning must extend carefully, Taylor and Fisher noted, to the station's promotion scheme.

With these ideas as guides, Taylor and Fisher work over an extended period with each station management to help the management develop a total campaign. Only such a campaign will be effective in lifting a station from the also-rans and keeping it near the front.

Two recent success stories exemplify what the Taylor-Fisher partnership can do. KXTZ in Las Vegas signed up with Master Broadcast in early 1979. The station previously had another Beautiful Music syndicator, and was running last in an 11-station market.

By the time of the April/May 1979 book, KXTZ was third in the market; in the October/November 1979 book it was second and was leading the number one station in certain important categories, including the 25 to 54 and 18 to 49 cumes.

In Miami, one of the strongest Beautiful Music markets in the country, four stations program the music; WYOR was last of the four in the ratings. The management signed with Master Broadcast in late 1979.

In the latest ratings WYOR has pulled ahead of the other three Beautiful Music stations in the market, quickly realizing the management's objectives.

The Miami experience emphasizes the quality of the music as the "beautiful alternative," as Taylor calls it. He says his programming wins in such situations because it is perceived as *different*. And Master Broadcast appears to be winning because the two principals have skills, between them, that reach to virtually every radio program operation need. **BM/E**

SAVE YOUR TUSH with our T.U.S.H.*!

Now Tentel has 3 products to make your video tape recorder work right

1 TENTELOMETER® tape tension gage



If you don't have a TENTELOMETER® for measuring tape tension, you're in worse shape than you know! Thousands are in use throughout the world! Send for our 16-page instruction manual.

2* TENTE U-matic Spindle Height (T.U.S.H.) gage



Save your valuable tapes from edge damage and binding and breakage problems simply and easily. "Greatest thing since soap," says one customer. U-matic now, BETA and VHS soon.

3 TENTE TIMER hour meter



For measuring the number of hours of "run" time to allow preventative maintenance to be performed to prevent down time.

Send or call for information and prices on the complete Tentel line. We want to help. We've already helped thousands.

Our toll-free number is
1-800-538-6894
(U.S. not including California)
8 a.m. - 5 p.m. Mon. - Fri.

**TENTEL 50 Curtner Avenue
Campbell, CA 95008
(408) 377-6588**

Circle 115 on Reader Service Card

If you think you own a CMX look and 34X edit

"Some day I hope to own a CMX." Occasionally we'll hear someone voice this wish. It's time for another look. With the design improvements and cost advantages we've built into today's 340X and 34X we think you'll want to include CMX in your future.

We have completed some advanced engineering and added new features to these computer-assisted editing systems, and we're delivering a brand new model, THE EDGE™. We've also come up with an impressive new way to generate CMX Edit Decision Lists using lower cost pulse count controllers. That's our EDL Logger.

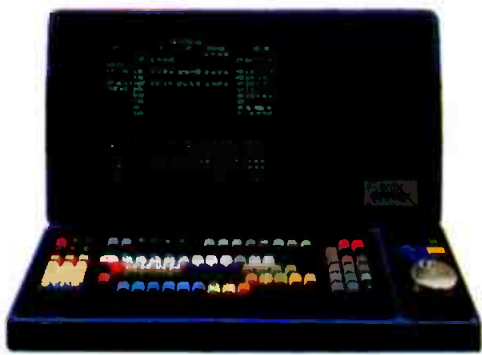

CMX 340X—Real Editing Power
There are lots of reasons why the CMX 340X is the preferred video tape editing system. Check the features we've illustrated on these pages—Motion Memory, Gismo, List Management and Auto Assembly. Add to this a software enhancement package that includes Editing on The Fly (Sync Roll), Master/Slave, Jam Sync and Second Audio. Also control of a production switcher, either directly or through its intelligence option is standard.

And with our distributed processing you own the ultimate in expandability. A central processor, or "supervisor", communicates with the operator and our Intelligent Interfaces™ (I²'s), or "specialists" in control of any one of many post-production VTR's, switchers and other devices. When you expand you simply add an I² for each device. Built-in expandability means long-term

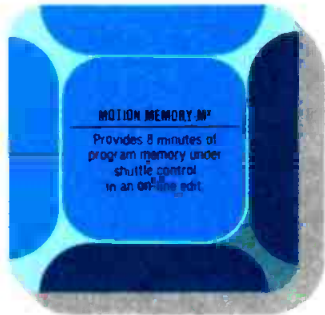

protection for your investment from the moment we install your CMX.

But the 340X is more than a combination of smartly-engineered electronic components. Installed and ready to use it is a complete system, a partnership that keeps you in post production. We think of it as our "total" commitment to you.

Today's 340X is a complete on-line/off-line system that includes a dual 8" disk drive for list input/output/copy, a printer, and a central processor designed to give you the option of MOS memory or core. All this editing power plus the widest variety of machine and switcher interfaces available.

So look again. Here's the real thing. A 340X in a three-machine configuration that's priced under \$55,000 in the U.S.

CMX 34X—Easy to Own
The CMX 34X is everything the 340X is, does everything the 340X does except control a production switcher and include the software enhancement package. If you want the long-range advantage of expanding to a full 340X system, start with the off-line capabilities of the 34X.



You can put the most complex transition in the Edit Decision List. By adding CMX's General Purpose Interface option you can control switchers and effects systems.

A 34X, with three I²'s, an 8" dual disk drive for input/output/copy, a printer, a 5 × 1 cuts and preview switcher, and full CMX list generation and list management is \$34,500 in the U.S.

For less than the price of a 1" VTR you can own the system everyone prefers to work with.



can't afford to at today's 340X ing systems.



THE EDGE™

Innovation in Editing

The newest technological advance from CMX is SMART KEYS™. They are the heart of THE EDGE, an

ingenious editing system that uses a CRT display to label 12 keys according to

their function. The system is so simple and logical that the next step appears on the screen.

THE EDGE is a two-source, one-record system that can do dissolves, produce a CMX-standard Edit Decision List with wipes and keys (in/out) and delayed transition events. It auto assembles or list processes with new record start and re-edit or ripple times. It includes two General Purpose Interfaces (GPI's) to control auto-transition switchers, digital video effects, character generators, etc. These GPI events, as well as splits (audio or video displays) and



dissolve/wipe durations, can be entered on the fly (MARKED). And locating any point in a scene is as smooth and easy as turning THE EDGE's Reel Motion Controls.

THE EDGE permits mixing of SMPTE time code and control track (pulse count) and works with 1", 3/4" and 1/2" formats.



Simplicity, flexibility, and versatility are hallmarks of THE EDGE. And its priced from \$17,000 in the U.S.

THE EDL LOGGER

The EDL Logger generates CMX Edit Decision Lists from a two-machine controller for 1/2 and 3/4" VTR's. This list can be either on paper tape, hard copy or both for use on a CMX. Wipes, dissolves and reel numbers can be included. It's priced at \$10,000.



THE PARTNERSHIP

It's all part of CMX's considered approach to editing—an approach that comes from perspective. We created the first practical video editing systems over 11 years ago and have consistently set new standards in the state of the art, year after year.

We've made sure that every one of the over 300 CMX video tape editing systems ever installed throughout the world is still operating today.

And it's this kind of commitment, not only to service and training, but to technological leadership that reflects the continuity of management at CMX/Orrrox.

CMX means creativity, expandability, efficiency and freedom from obsolescence. CMX means editing.

TM Orrrox Corp

CMX ORROX

The World Standard for Editing

Orrrox Corporation 3303 Scott Blvd., Santa Clara, CA 95050 (408) 988-2000 Telex 910-338-0554 Chicago (312) 325-8488/Los Angeles (213) 980-7927/New York (212) 371-1122 International Representatives: Magna Technics Pty. Limited, Artarmon, N.S.W., Australia/Tosyu, Tokyo, Japan/TeknoMerica, S.A. Mexico City/F.W.O. Bauch Ltd., Herts, United Kingdom/Thomson-CSF, Gennevilliers, France/GTC GmbH, 2070 Grosshansdorf, W. Germany

Circle 116 on Reader Service Card

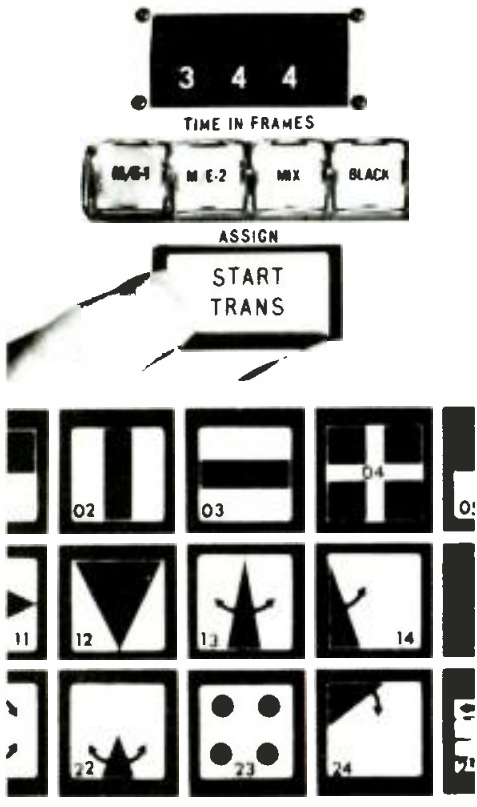

No matter what your company's production specialty, news, commercial, programming, or instructional television, the American Data complete line of video production systems have the features you'll need to do the job.

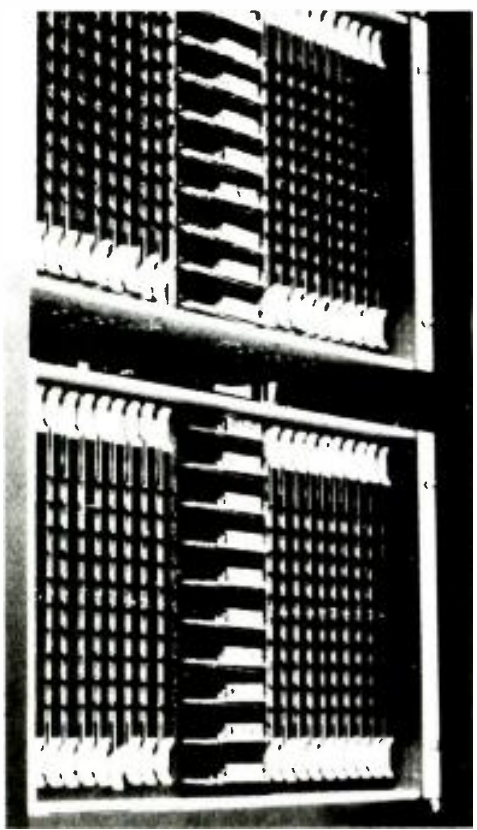
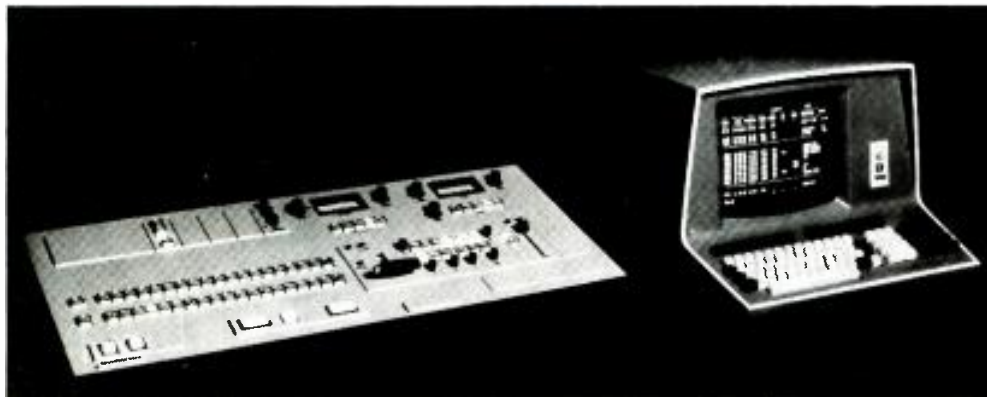

American Data

Research Park • 401 Wynn Drive
Huntsville, Alabama 35805 USA
Phone (205) 837-5180
TWX 810 726-2125

A North American Philips Company

ADC NORTHEAST
401 Wynn Dr.
Huntsville, AL 35805
(205) 837-5180

ADC SOUTHEAST
401 Wynn Dr.
Huntsville, AL 35805
(205) 837-5180

ADC MID-ATLANTIC
Box 364
Washington Grove, MD 20880
(301) 258-7676

ADC MIDWEST
P.O. Box 27324
Indianapolis, IN 46227
(317) 784-3000

ADC WEST
3760 Cahuenga Blvd.
North Hollywood, CA 91604
(213) 760-3221

ADC N. CENTRAL
1121 Riverwood Drive
Burnsville, MN 55337
(612) 890-8920

ARGENTINA:	WESA, S.C.A.
AUSTRALIA:	Magna-Techtronics
AUSTRIA:	8FE
BRAZIL:	Centelec
CHILE:	RAYLEX
DENMARK:	JAI Jorgen Andersen
ENGLAND:	Crow of Reading
FRANCE:	REA
ITALY:	TV Research S.P.A.
JAPAN:	Sigma Engineering
KOREA:	Kim Oh & Company
MEXICO:	TeknoMerica, S.A.
VENEZUELA:	ESOMA Corporation
W.GERMANY:	8FE

VERSATILITY WORLDWIDE

Circle 117 on Reader Service Card

TELEVISION

PROGRAMMING & PRODUCTION FOR PROFIT

Small Market Craftsmanship — Two Award-Winning Documentaries Show How

INVESTIGATIVE REPORTING, extensive interviews, historical research, and the use of government archival films are the magic ingredients that have gone into two award-winning documentaries produced by small-market stations.

"Target: Tucson" was produced by Mike McKee and Tom Tanquary of KVOA-TV, an NBC affiliate in Tucson, Arizona, ADI-90. It is their first documentary, a 30-minute special report, and this year's winner of the IRIS public affairs award for small markets.

"Clouds of Doubt," produced by Karl Idsvoog, Lucky Seversen, and Michael Younger of KUTV, Salt Lake City, ADI-47, received the Edward R. Murrow Award for documentaries from the Radio-TV News Directors Association (RTNDA) this year.

Both documentaries investigate the role of the government in relation to nuclear defense. "Target" concerns itself with civil defense procedures in Arizona in the event of a nuclear attack, and the basic futility of evacuation procedures in the event of immediate conflict. "Clouds" deals with a government cover-up of the ill effects of nuclear ground testing in the 1950s and 60s.

While television documentaries have been popular with broadcasters for a long time, critics say they're too costly for the small station to produce and don't attract enough viewers.

In the case of "Clouds" and "Target," both documentaries were produced outside of regular station time, requiring the help of volunteers. Both used, for a substantial part, government films provided free-of-charge by the military or a government agency. In such ways, costs were kept to a minimum. "Target" took a year to make; "Clouds" was the result of three years of news-gathering and research.

While no exact figures were available on how much the documentaries cost to make, Idsvoog pointed out that his documentary was a lot cheaper than any large station production because the time was put in by the producers themselves.

"In one month I put in 120 hours of

overtime which I didn't get a single penny for, because I'm on straight salary," Idsvoog said.

Idsvoog works out of a special investigative unit, separate from the regular news department of the station.

Idsvoog says, "We were able to show quite conclusively within the documentary that the government basically lied to the people of this country about the health effects of radiation. The government knew what it was doing and covered up the information and lied to the people."

The hour-long report is a detailed piece of investigative work, including interviews with scientists, citizens, and government officials. Probably the strongest interviews are those done with persons believed to have been affected by radiation as the result of nuclear testings.

Idsvoog and his team covered a lot of ground in the three years it took to make the report. While a number of lawyers were interviewed, they were not included in the documentary. Coverage included the public hearings on the matter, and Stuart Udall, former Secretary of the Interior, contributed information. Trips were made to Washington, Houston, Atlanta, San Francisco, and throughout southern Utah and Nevada. Interviews were conducted with Linus Pauling at his home, as well as with other scientists. Aerial footage was used and location shots were taken at various nuclear test sites in Nevada.

"The big problem," says Idsvoog, "was getting any kind of straight answer from the Department of Energy."

Such investigative work takes time. While pieces of the documentary had been used as news items for the station's regularly programmed news, the documentary is not a recycled piece of journalism.

Made in two segments, the first half-hour covers various scientists giving background and technical information on nuclear testing and its effects. The second half deals primarily in interviews with private citizens and government officials. The documentary takes a hard look at the efforts of

CHYRON

The
electronic
graphics
people

CHYRON

TELESYSTEMS

DIVISION OF CHYRON CORPORATION

265 Bethpage-Spagnoli Road

Melville, New York 11747

Telephone: (516) 249-3296

Telex: 144522 CHYRON MELV

*Ampex International is exclusive distributor for
Chyron Graphics Systems outside the U.S.A.*

Circle 118 on Reader Service Card

BM/E SEPTEMBER, 1980 25

TV Programming

Congressional legislation. Sandy Gilmore, a reporter with KUTV at the time the documentary was being made, interviewed at length Paul Cooper, a victim of the testing. While a direct correlation between fall-out and cancer is established, the report focuses on the government's responsibility and the difficulty victims have in making their claims.

Three-quarter-inch videotape was used throughout. When film was used (as in the case of government-supplied footage) it was transferred to the tape and edited. The documentary uses a good amount of military and government film, including footage of nuclear testing, official agency releases, and the like. Ikegami HL-79 and TK-76 cameras were used in the field for interviews.

The individual segments were completed on 3/4-inch tape, then the bumpers, effects, and inserts were put in during final production. The bumpers show a freeze frame while titles are rolled and colors change from white to burnt orange. All this work was done at times when the regular production equipment was not otherwise in use.

"Clouds" was aired at prime time by KUTV and also by KLAS-TV in Las Vegas. Actual production time was not as difficult to get as the time spent on research. "When it finally came down to a lot of the shoots, I had been talking to these people for so long that it wasn't terribly difficult. A great deal more time was spent on research than actual going out and shooting interviews," said Idsvoog. Sue Lavery, a research assistant, contributed heavily to the documentary.

"Target: Tucson"

"In the event of a nuclear attack, what do you do, where do you go?"

These questions are answered in detail by the TV documentary "Target: Tucson," produced by McKee and cameraman Tanquary of KVOA-TV.

The subject was of special interest to Tucson residents for a number of reasons. For one, the proximity of nearby Davis-Monthan Air Force Base makes Tucson a strategic area.

"Tucson is, according to the Defense Department, one of the top 10 targets in the country for the Soviet Union," says McKee, who narrates and interviews. "The reason is the Titan missiles. So we looked at *why* we were a top 10 target; what *they* were going to do about it."

Again, as in "Clouds," research and gathering historical data were the most time-consuming parts of putting together the documentary. Air Force footage of the Titan missiles arriving



Fact-finding requires extensive research. Reporter Mike McKee confers with Annie Reed of KVOA-TV, Tucson



Both McKee and cameraman Tom Tanquary received kudos for editing. Their project required donating off-station time

for the first time in Tucson was used.

"All weapons footage came from the Air Force, pretty much," says McKee. "with the exception of things we were able to film at the missile sites and the Air Force base."

All footage was shot on 3/4-inch tape, using RCA TK-76 cameras and Sony BVU-100 recorders. Again, as in the case of "Clouds," film footage was dubbed to tape and edited. As far as on-location work and interviews, nothing other than the usually equipped news cars were used.

McKee and Tanquary both contributed their free time to the project, shooting on weekends, after regular station hours, or whenever they had the free time. Time was the biggest problem, admits McKee, since both he and Tanquary had a full schedule of regular newsgathering to accomplish every day.

"We interviewed about 40 to 50 people overall in person, lots more on the phone. The length of the raw interview was a half-hour to maybe some 10 or 15 minutes."

McKee served as the on-camera talent. Tanquary shot the interviews. As far as what went into the documentary itself, McKee says there were anywhere from three-minute interviews to soft "bites" of someone making a particular point. A great deal of mileage was obtained from the available interviews.

"The longest interview in the documentary is with a person from the Congressional Office of Technology Assessment, explaining what would happen in the event of a nuclear war or if a nuclear missile hit Tucson."

No particular special effects were used in the documentary. Standard dissolves and fades were used. Historical time capsule footage featuring John F. Kennedy speaking about the Nuclear Age was added at the end of the documentary.

Tanquary, the chief photographer, shot the tape, and both newsmen edited the footage. Since KVOA had previously made stories about the Titan missiles, some interesting archival tape was available, as well as film, includ-

ing shots of the missile silos and missile sites.

McKee says there was little difficulty getting the pictures they wanted. "The Air Force was real cooperative. They went out of their way in some cases to help us out. Our particular station has good relations with the Air Force base here."

McKee says the major difficulties had to do with getting on location, finding time for editing, setting up interviews — all along with the daily news-gathering operation of the station. Again, most of the time was spent doing research and gathering historical data.

The producers of "Clouds" and "Tucson" both relied heavily on available resources and manpower. While limited by a number of factors, including time, money, and personnel, they were able to overcome shortcomings by spending time to get exactly the pictures and the interviews they wanted. The government and military-supplied films were free and added a dimension to the documentaries that wouldn't have been possible otherwise: the historical perspective.

In the case of "Tucson," McKee and Tanquary kept a close working relationship and the project was a personal one. For this reason they could make immediate decisions without too much consultation, as would have been the case if a larger team had been putting together the documentary. They spent a year putting together the story, and not having to work under any immediate deadline gave them the flexibility to put together a quality piece of reporting. The only piece of equipment McKee would have liked to see updated was the studio's production switcher. "Any time you have better equipment," he says, "it makes the job easier. But you can do the same job with what we had."

Both documentaries show that small stations can put together quality productions if there is the dedication and the time. While equipment for the most part is not a limitation, time is, and a well-organized approach ensures the success and progress of such a project.

The documentaries were not overnight ideas initiated on the spur of the moment. Both were the result of a series of follow-ups and the cumulative results of years of newsgathering efforts. In both cases, research was of primary importance, and the journalists' relation with the government, military, and state agencies was paramount.

The success and depth of these two special award-winning reports show that small market stations can produce documentaries in ways that the larger stations cannot: patience and dedication are the elements of craftsmanship.

BM/E

**WE'VE
GOT WHAT
IT TAKES!**



Our T-1024S Series provides broadcast features at a remarkably low price. While compact, it boasts an 8 page memory expandable to 16 pages, auto line centering, character insert/delete, and a highly legible display of 24 characters per line using a 10 x 14 character matrix.

Priced from \$1695.00

TITLING . . .
Made easy . . .
Made affordable



Priced from \$3995.00

Our T-1000A is designed for simplicity of operation, and offers many broadcast features at a surprisingly low price. Fingertip controls provide access to a 16 page memory with simultaneous program and preview display channels, variable length roll, crawl, adjustable title window, and eight choices for character font enhancement.

A stand alone character generator to internal sync for billboard-type messages. Only our CG-832 provides these features at this low price: 8 page memory expandable to 16 pages, auto line centering, character flash, optional fixed title, LED page display, and optional color background and power failure protection.

Priced from \$1695.00

**WEATHER &
MARQUEE . . .**
Made easy . . .
Made affordable



Priced from \$3450.00

The industry's lowest price TBC featuring full video processing with unique sync stripping and AGC control. Also features video and sync level monitoring, floating 1N window and adjustable blanking. Unique integral split screen generator or pulse cross display permits visual monitoring of the corrected or uncorrected video signals.

NOTE: All products are available in NTSC or PAL configuration with exception of the V-Tec.



Video Data Systems

corporate office: New York, NY (516-231-4400)

national sales: Salt Lake City, UT (801-272-9296)

international sales: CATEC AG LUZERN, Luzern Switzerland (041-22-66-19)

Circle 119 on Reader Service Card

BME SEPTEMBER, 1980 27

FREE* FOR

AUDIO CONSOLES (The Silent Series)

SC-5, DC-5, DC-8: 5 & 8 mixer, 12 to 18 inputs: \$1,297 to \$2,725.



PSM: Portable; 5 mixers, 8 inputs; built-in compressor: \$545.

DC-12: Remote control; up to 12 mixers (expandable to 20) with 2 inputs each: \$4,791 to \$5,963.

THE PHASE-ERROR-FREE CART/CASSETTE PRODUCTION CENTER PhaseMaster:

Phase-error-free record reproduce/duplicate of cartridges and cassettes; full complement of broadcast features and construction.



DC-38: 5, 8 or 10 mixers, up to 40 inputs: \$2,871 to \$5,181.

MA Series: Studio monitors; 12 W mono, 20 W stereo; 20 Hz - 70 kHz ± 2 dB; distortion 0.05% max: \$121 and \$153.

MIC/LINE/STUDIO AMPLIFIERS

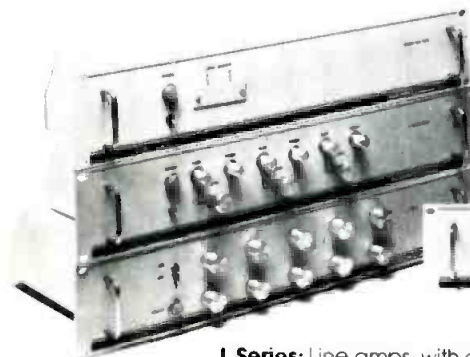

SMA Series: Studio monitor; 25 W rms/ch. mono/stereo; 15 Hz - 50 kHz ± 1 dB; distortion 0.6% max: \$219 to \$355.

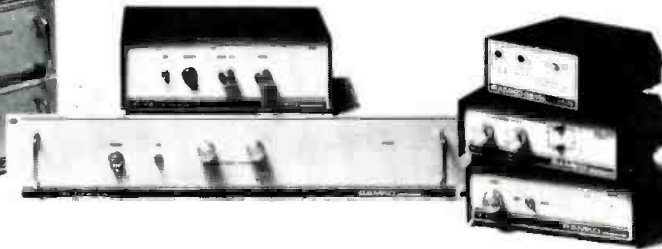

L Series: Line amps, with or without equalization; up to 10 mono, 5 stereo ch.; solid-state balanced and unbalanced inputs: +21 dBm max. in and out; response 10 Hz - 50 kHz ± 0 , -1 dB; distortion 0.008%: \$135 to \$507.

MLA Series: Mic/line inputs; studio or remote: \$129 to \$209.



DML Series: Dual mic in to amplify, mix, limit and control gain; built in compressor, AC and DC: \$243 to \$319.

AUDIO ROUTER/AMPLIFIER

ARA-1612: Up to 16 in, 12 out; LED status display: \$1,338 to \$3,052.

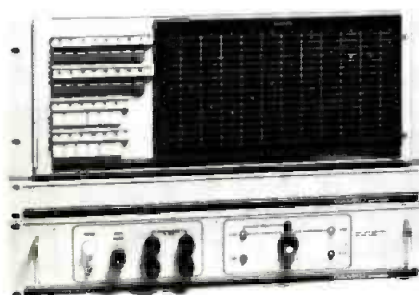

TURNTABLE PREAMPLIFIERS

MP-8 & SP-8: Mono & stereo; S/N -77 dB; ± 1 dB RIAA: \$101 & \$145.
ESP-38: 0.03% distortion; S/N -85 dB; ± 0.25 dB RIAA: \$325.

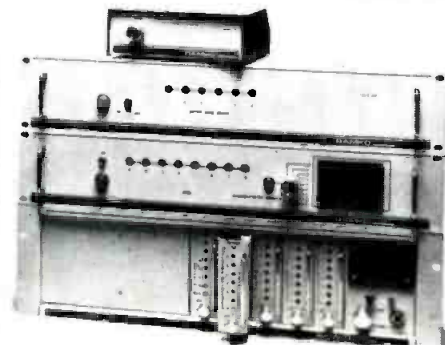

AUDIO DISTRIBUTION AMPLIFIERS

DA Series: 10 versions from 1x30 mass feed to 20x80 rack mount; 20 Hz to 20 kHz ± 0.5 dB, -75 dB separation: \$160 to \$2,476.

Prices subject to change without prior notice.

2 WEEKS.

*You can use any of the gear you see free for 2 weeks (with credit approval prior to shipment).

Play with the cart/cassette record/playback/duplication center that eliminates stereo phase shift error once and for all. The most advanced turntable preamp in captivity. Consoles so advanced, so silent you're not going to believe them until you try them. Or an audio router that makes whatever you've got now look—and sound—like so much spaghetti.

Then, if it's not for you, just ship it back.

But in all fairness, we have to warn you—once you've tried Ramko, chances are you're hooked for life.

No more phase shift error

The Ramko PhaseMaster provides phase-error-free recording/reproduction/duplication of your carts and cassettes, with performance specifications that meet or exceed whatever cart drives you're using now.

Instead of adding failure-prone electro-mechanical components or re-inventing the cartridge, we simply encode the stereo before it sees the heads or tape, then use this recorded information to eliminate any phase shift error introduced by the heads or cart when you play the signal back.

Features of the Ramko PhaseMaster include two A and B cart decks and a cassette deck. Simple cassette-to-cart(s) and cart-to-cassette duplication. Automatic switching of record/playback, encoding/decoding and mono/stereo. Left, right and phase analysis meters. Front panel input selection. Three cue tones.

And so much more that you'll just have to contact us for details

and a demonstration. Ask for the Ramko PhaseMaster.

Just another turntable preamp?

Look at what one user wrote: *"Three days ago I replaced the (brand name) preamps in our studio with your ESP-38 preamps.*

"The result was astounding. The next day we had six unsolicited calls from local stereo stores. All commented on our improved disk reproduction and wanted to know what we had done."

Try it. You're going to like it a lot.

Consoles for AM stereo, or an FM station upgrade

Ramko consoles come with features you won't even find in more expensive competitive units.

Total dc control of all mixing and switching functions means no more noisy pots and switches, no stereo tracking error, and much more resistance to RFI.

We've developed solid-state balanced inputs for better sound. Added gain select on each input. Included switch-programmable cue and monitor mute selection. Provided mono, stereo and phase meters.

Get your hands on a winner now.

Kiss your patch panels good-bye

Because with the Ramko ARA-1612 Audio/Router Amplifier you use front panel pushbuttons or remote controls to route 16 inputs to any of 12 outputs, simultaneously or individually, with an instant LED display of what is going where.

You've never seen anything like it. IC switching and isolation buffers mean no loading and no

degradation of S/N or frequency response with multiple feeds (stack additional units for up to 45 in and thousands out). On-board switches allow stereo and/or mono operation. Individual gain control on all inputs allows precise level matching. Response is 20 Hz-20 kHz ± 0.5 dB; S/N is -75 dB; distortion < 0.3%; and input/output levels are +21 dBm max.

And all this is yours at the lowest cost per crosspoint in the industry.

For moving sound around

Ramko offers more different kinds of amplifiers than anybody.

Ten models of Audio Distribution Amplifiers, each with 20 Hz-20 kHz ± 0.5 dB frequency response, less than 0.1% distortion, and more inputs and outputs for the size and price than any other comparable ADA.

Four different Line Amplifiers with 20 Hz-50 kHz $\pm 0, -1$ dB frequency response, 0.008% distortion, balanced in and out, and +21 dBm max out.

Portable and studio dual function MIC/LINE amplifiers with balanced in and out, built-in RFI suppression, 20 Hz-20 kHz ± 0.5 dB frequency response, gain from 64 dB on MIC to 26 dB on the high level channels, and distortion at an inaudible 0.1%.

And now, our warranties...

We build our products so well that we back them with two-year warranties (four years on the DC-12 and DC-38). And isn't that music to your ears?

To hear more, contact: Ramko Research, 11355 Folsom Blvd., Rancho Cordova, CA 95670.

Or just call (916) 635-3600 collect today.

RAMKO

See us at Booth 505/506 NRBA

Simply fantastic picture quality. Fantastically simple set-up. Get both with our renowned TK-47.

Press a button, and it sets up automatically. In seconds, instead of hours. File and recall six basic lighting situations, and get great picture quality—instantly—under any conditions.

All RCA cameras are built to extend your creativity, lighten your chores, and deliver the very best on-air product.

Our TK-76C is light, rugged and agile enough to go anywhere and start shooting right away.

Our TK-760 has enough heft for smooth studio work, yet is light enough for easy transport to the field as an EFP camera.

And with them all comes famous RCA TechAlert service to keep you on the air, come what may. Your RCA Representative can tell you more. RCA Broadcast Systems, Building 2-2, Camden, N.J. 08102.

SIMPLY FANTASTIC.



Can you really
afford less?

LIVE! FROM ATLANTA— IT'S CABLE NEWS NETWORK

For the past decade, cable television has laid claim to increasing portions of the broadcasting marketplace — nearly 30 percent of U.S. households now have access to cable services. Until recently, however, cable seemed a medium without a message of its own. Ted Turner aims to change that.

LIVE FROM WASHINGTON, Daniel Schorr reports on the White House while a lower corner of the TV screen shows a heatwave shimmering off a Dallas street. When the picture cuts to a high-tech newsroom in Atlanta, a revolving set turns for a national weather report. By 7:00 p.m. Lou Dobbs is anchoring *Moneyline* live from New York's World Trade Center.

This is the kind of news millions of cable watchers are getting across the country and the kind of programming that's making more than a few network executives a little nervous. It's Ted Turner's Cable News Network, now in its fourth month of providing 24-hour, seven-days-a-week news programming via U.S. cable systems.

While nothing is new about 24-hour news, CNN is the first television effort with an all-news format. Media analysts say it's still too early to know where the fledgling operation is headed, or even if it will survive; even so, CNN is attracting some heavyweight sponsors and major subscribers with aggressive marketing, special ad deals, and what some labor unions see as questionable management practices.

In order to survive, Ted Turner is breaking some established rules of the TV trade and gambling in a big way: insiders say he's prepared to give CNN an 18-month run, putting his initial investment of 34 million dollars on the line.

The numbers game

At present, it's costing Turner three million dollars a month to run CNN. Subscribers number more than 2.3 million, according to CNN estimates, leaving quite a gap to be filled before its five million target for the first year is reached. The average audience tuned in to the net numbers 105,000. Carriers pay 15 to 20 cents per subscriber to carry the service. Two minutes of the 12 minutes per hour allotted for advertising are given to local carriers for sale.

Analysts say CNN needs 500,000 new subscribers per month to make it into the black, so the net restructured its rate system July 1 to encourage MSOs (multiple system owners) to sign up. MSOs hold the key to Turner's success or failure — the big ones, such as Teleprompter, ATC, TCI, and Warner, have bought CNN but only for carefully selected markets, testing for consumer reaction. CNN sells its 30-second commercial segments for \$100 to \$700, but other deals are being promoted including sponsorships and charter commitments. In its second month, CNN began with Bristol-Meyers as a charter client with a \$25-million, 10-year commitment, adding on Proctor & Gamble with an estimated million-plus order last month. Recent clients include Atlantic-Richfield, GTE, General



Husband and wife team, Lois Hart and David Walker, anchor the CNN news operation from the open newsroom in Atlanta



Earth stations are part of Turner's satellite system, making 24-hour news a reality

Foods, Duracell, Sylvania, and *Life* magazine — so far over 30 clients. While some seek to test the new frontiers of the cable market, others want to reach the educated, upper-income audience that cable claims. Whatever the reason, advertisers are climbing on board faster than subscribers. Cable News Network's president, Reese Schonfeld, admits that cabling aren't signing on as fast as expected, but he's pleased with the growth of advertising sales. To promote subscriber growth, Turner substituted programming on his superstation WTBS-TV, Atlanta, this summer with the 24-hour news service, allowing five million cable subscribers to see CNN's programming. It may work. His last broadcasting coup had been to turn WTCG — a money-losing UHF outlet — into the coun-

Here. Now!

Your interface to the future.

630 Frame Synchronizer.



Digital still store . . . digital graphics . . . real time picture analysis . . . whatever the future holds, the HVS-630, with its built-in digital I/O interface, is ready.

And, for today's needs, the 630 has both frame and field freeze, plus a built-in TBC that outperforms the best stand alone units. RGB (in and out) is also standard. Use it to do something special.

The key to the 630's performance is a unique system that processes the video signal in component—instead of composite—form. This technique is inherently immune to H-picture shift, cycle jump and color phasing.

As a result, edits and hot switches are handled smoothly. Chroma and luma are processed separately to make maximum use of picture improvement technology.

An optional Compressor/Positioner/Effects unit provides even more versatility. Choose pushbutton and/or joystick controls. Also optional is a plug-in digital noise reducer that reduces noise by 12 dB, without motion artifacts and resolution loss.

So, for the best return on your synchronizer investment, invest in the synchronizer with a future: the HVS-630. For a demonstration, call or write.

HARRIS



COMMUNICATION AND
INFORMATION PROCESSING

HARRIS CORPORATION Harris Video Systems
1255 East Arques Avenue Sunnyvale, CA 94086 (408) 737-2100

Circle 121 on Reader Service Card

www.americanradiohistory.com

Cable News Network

try's first superstation beaming a nationwide programming schedule via satellite. To meet FCC requirements, WTCG offered a 4:00 a.m. newscast, but it featured hi-jinx like lemon meringue pie in the news director's face. The station now reaches six million homes.

Pros at the top, personalities on camera

Turner has been able to attract some of the most innovative and knowledgeable executives to work for him. Reese Schonfeld had been managing director of ITNA before his move to CNN. Executive vice president Burt Reinhardt was responsible for starting the U.S. network operations of UPI television news. Head of the news gathering operation is Sam Zelman, CNN's executive producer and former executive news director for CBS News. Another CBS veteran is Bill McPhail, vice president of CNN Sports. For his senior news producer, Turner invited Ted Kavanau, Emmy award winner for news work in San Francisco.

On-camera talent includes Daniel Schorr, William E. Simon, Richard Reeves, Dr. Joyce Brothers, Bella Abzug, Phyllis Schlafly, and Barry Goldwater.

Mary Alice Williams, CNN's New York bureau chief, explains she went to CNN from WNBC because of the growth potential. "It's an exciting place to work," she says. "Here everyone can seek their own level." And seek they do. Turner has created the position of "video journalist," filled by mostly young, relatively inexperienced people who do everything from answering the phone and making appointments to going into the field for stories. At the New York bureau, for instance, one video journalist reports on fashion, the industry she came from before going to CNN. Another says he was a grocery clerk before signing on. "We don't have the union-related problems of other stations," says Beth Perrella, an intern who came from WBZ, Boston. "Here we can do a lot of things — write stories, edit, do interviews. You get a lot of experience since this is a non-union shop."

CNN also is signing on local broadcasters to act as stringers in cities where there are no CNN bureaus. In exchange for use of news stories, CNN will let a local station use any portion of its news feed for its regular programming. This is a bonus for those stations that have had to rely on other sources for national and world news. A news director at one local station says, "Having material that hasn't been broadcast will end a lot of nightmares."

The New York bureau reflects the do-all-or-die attitude of a new station. Still in the building stages (24-hour cable monitors have yet to be installed and workmen were still busy putting in the revolving door when *BM/E* visited), the studio is a glass-enclosed room in the lobby of One World Trade Center. The news set is flanked by desks, video equipment, and staffers — all exposed to public view. Enthusiasm is evident. While one intern tears newswire next to the chief's desk, another calls out "Five minutes!" and Mary Alice Williams takes the copy and steps up for the five-minute feed to Atlanta.

Local officials at AFTRA say they're in close touch with CNN personnel, many of whom are union members. "They're paid well," says a union spokesperson, "but they have to grow up a bit." Union organizers are taking a wait-and-see attitude toward the young network.



Everything from live feeds to field reports are handled by staffers at CNN's New York headquarters

Satellites make live-news work

According to Bill Papa, CNN's manager of satellites and circuits in Atlanta, all of CNN's bureaus (Washington, New York, Los Angeles, Chicago, Dallas, San Francisco, London, and Rome) were up and operating the day the net went on in June. "The one thing we were not capable of doing at the time were live shots, inserts, from some of the bureaus. We're still working on that as far as half of them are concerned," he said.

Basically, the flow from the bureaus has maintained itself during the first two or three months of operation. Studio live capabilities are going up from all the bureaus. Remote capabilities are still being completed. The Washington bureau, which provides the bulk of CNN's news programming, does have remote and studio live feeds. Remote trucks are being built for San Francisco, Chicago, and New York.

Coming from ABC New York, Papa says the big difference is "a lot less red tape, a lot less bureaucracy."

A good example is the way the convention coverage was handled. "Using our incoming capabilities, we were able to cover the convention pretty much as we pleased, without any large commitment. We set up a portable uplink in Detroit, through Starlink, and we arranged bureau feeds. There was really no great sacrifice on anyone's part as far as covering the convention was concerned. We still took a full load from all our bureaus, we still did our regular programming and covered as much of the convention as we wished."

Papa says CNN's concept of network feeds is substantially different from those of other major networks. "While ABC, for instance, puts up an uplink and doesn't stop, CNN's programming isn't based around such an event. The convention was fit into the programming." The Democratic Convention, he says, will be handled in the same way.

"Immediacy" is the catchword at CNN. An example was when Carter went to Italy. "We were in a pool with the networks," says Papa. "Everyone was feeding in pictures of Carter landing in Rome. We saw the picture on the networks a couple of hours later on their evening news. But as Carter was landing, everyone watching CNN saw it live."

CNN is using Westar and other domestic satellite services including RCA and Comstar. So far, CNN managers say it's the cheapest way to go.

Cable News Network

Following the loss of Satcom III in space, a number of problems arose concerning transponder room for CNN. After a lottery and an out-of-court settlement the picture looks rosier for CNN. A new 24-transponder bird will go up next year carrying the 20 transponders for cable originally slated for Satcom III. RCA Americom, operator of the Satcom system, had originally planned to transfer cable room on Satcom I to Satcom III. CNN agreed to drop its suit against RCA in exchange for making its spot on Cable Net One a permanent one. RCA agreed to extend service to CNN on Cable Net One for three years. CNN will use Satcom I until the move a year from now.

All-electronic newsrooms

CNN's Washington bureau supplies a bulk of the net's news programming with live feeds to Atlanta every half-hour. These include live studio reports, edited news stories, and material from the White House, State Department, and Capitol Hill. A package format is used more extensively during the 8:00 to 10:00 p.m. time slot. This kind of news coverage demands good organization and a well-equipped ENG crew. CNN contracts with Mobile Video Services in Washington to supply field equipment and personnel. They will be working during the coverage of the Democratic Convention in New York. MVS has set up seven two-person ENG crews in Washington, equipped with RCA TK-76 cameras and Sony BVU recorders. Material from the field is sent to the bureau by courier, AT&T Long Line, or microwave. At



The bureau at One World Trade Center originates CNN's financial and Wall Street reports



"Immediacy" is the catchword at all CNN bureaus. All levels of personnel are able to work together with a minimum of red tape

the studio, the material is edited using BVU-200s and BVE-500A controllers. Ampex VPR-2s and an HPE-1 editor are used for one-inch editing. The studio camera is a computer-controlled RCA TK-47. A Grass Valley 1600 production switcher is in the control room. All audio boards are Yamaha PM 430s with a PM 700 master. The Grass Valley 400 routing switcher is the primary piece of equipment used to route both audio and video, independently if needed. Signals from a field microwave, for example, can be sent directly to an edit room.

Keeping track of assignment, routing, equipment, and stories takes much in-house communication. A Clearcom intercom system has been designed to keep operations in order. A two-way radio system covers base stations, mobile units, 17 portables, and satellite receivers.

In the newsroom, computers are being used to the maximum. The system, called News Fury, was designed by Peter Vesey and Robert Barnes, CNN director of computer services. BASYS of San Diego put together the software and the system is the first of its kind in broadcast journalism. Computer terminals allow news personnel to review stories, edit and store items from UPI or Reuters, prepare graphics, and put copy in boldface for teleprompters. The system handles both editorial and production sides of the news operation. Once a story is written on the terminal, all others throughout the system have access to it. CNN's national bureaus are all linked to the system, which is capable of storing information on upcoming news events and lists items for editors and producers. News personnel can also send messages back and forth through the system. Hard copy can be produced for backup and the new network predicts the system will save as much as a ton of paper a day.

Attracting the specialized audience

CNN still has to determine how its audience will respond to news programming 24 hours a day, seven days a week. Who watches what and when? An emphasis is being placed on weekend programming as studies made by MSOs have found that a large portion of cable subscribers watch cable on Saturdays and Sundays. So far, sports has been the traditional fare of weekend programming. CNN is trying out talk shows, call-in programs, and news quiz shows besides the usual news and weather reports.

At present, CNN offers prime time news, women's features, business and finance, sports, and "soft news" — including consumer reports with Ralph Nader, health advice, movie reviews, recipes and food, and Hollywood gossip.

An interesting program feature is CNN's 11:00 p.m. national call-in. For one hour, this talk show features an in-depth survey of various issues with guests live and via satellite.

CNN also has an agreement with Canadian Television Network to use their news feeds from Peking. When operational, CNN may be the first U.S. network to deliver news directly from China's capital on a regular basis.

In the final analysis, it will be the product that determines the failure or success of Ted Turner's dream. Personalities, technology, and hard news gathering capabilities all seem to be present throughout the CNN operation. What remains to be seen is the response of the American public. Will they buy it? If so, Cable News Network will be ushering in a new era of television and changing the look of broadcast journalism. **BM/E**

FOR PRECISION INDEXING

EECO MTG 550 TIME CODE GENERATORS



EECO's MTG 550 Series SMPTE/EBU Generator incorporates the latest state-of-the-art CMOS/LS TTL logic resulting in reduced size, weight and power requirements.

Slave and user bit input options are now standard together with new alarm features at reduced costs.

Instant reliability is assured by exclusive use of aged burned-in integrated circuits.

Four low price Models are now available.

MTG 551—NTSC MTG 553—SECAM
MTG 552—PAL B MTG 554—PAL M

NEW MICRO-PROCESSOR BASED TCR-650 EDIT TIME CODE READER

With Exclusive Tach-Pulse Operation



- On Time Display/ Data Outputs
 - Display Binary Word (Full Hexadecimal Capability)
 - Restored Serial Code Output
 - Time Code and/ or Tach Pulse Operation
 - Selectable Input Tach Pulse Rates
 - Optional Synthesized Code Output From Tach Pulses
- Two operating modes provide:**
1. A combination Time Code/Tach Pulse mode in which input code updates reader when valid code is available, and continues to update from input Tach Pulses when Time Code is invalid due to low or high tape speeds.
 2. A Tach Pulse only mode in which an initial count can be present and then updated from Tach Pulses. An option is available that generates a synthesized serial SMPTE/EBU code derived from Tach Pulse input.

EECO's TCR-650 is a micro-processor based system consisting in part of both hardware and software design. The latest state-of-the-art CMOS/LS TTL circuitry has been incorporated resulting in reduced size, weight and power requirements.

FOR PRECISION POST-PRODUCTION AUDIO ENHANCEMENT

THE EECO MQS-100 SERIES SYNCHRONIZER

EECO's Micro-Computer based MQS-100 that cues and synchronizes any three audio/video transports — simultaneously, now has added features.

- Simplified system controls
- Reduced lock-up time
- Improved data transfer
- Three event commands
- Six scratch pad memories
- Interfaces available for over 14 tape transports

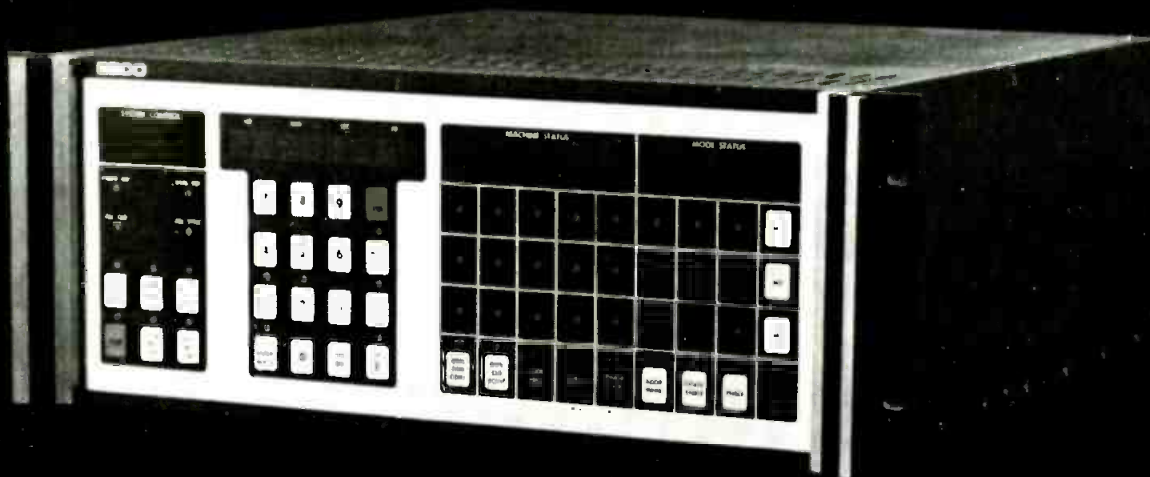

AMPEX AMPEX is a world wide distributor for EECO Broadcast Products.

EECO
Incorporated

1601 East Chestnut Avenue • Santa Ana, California 92701 • Phone: (714) 835-6000 • TWX 910-595-1550 • Telex 67-8420
Circle 122 on Reader Service Card

Now you're telling us...

...why TV broadcasters continue to specify 2/3-inch Plumbicon* tubes in their ENG/EFP cameras.

Two years ago when competitive 2/3-inch camera tubes made their appearance, we said "...in the final analysis only you, the broadcaster, will be able to judge the *system* performance of these other 2/3-inch tubes by comparing their in-camera performance with that of Plumbicon-equipped cameras."

Today, after the broadcaster has had the opportunity to make this comparison of the in-camera performance of the Plumbicon versus the Saticon

(Registered trademark NHK/Japanese Broadcasting Corporation), TV professionals across the nation have made the Plumbicon the leader. To date we've delivered more than 8000 2/3-inch Plumbicon tubes in the U.S.A. and the pace is still picking up.

Here's what we've been hearing from broadcasters about the crucial factors that affect the "in-system performance" of ENG and EFP cameras... Sensitivity, Resolution and Burn-In:

*Reg. T.M. of N.V. Philips of the Netherlands

SENSITIVITY: The ability to shoot and air pictures under the most severe and often uncontrollable lighting conditions is of first importance. When it comes to "get the footage now or forget it", the choice of a Plumbicon-equipped camera over a Saticon gives you that *extra measure* of sensitivity that allows you to get the job done.

RESOLUTION: If your business is demonstrating a camera on a still scene or a test pattern, then static resolution is important. If however, your business is making good video under all conditions, especially those difficult ENG and EFP action shots, then you're telling us that it's total resolution that counts. While the Saticon tube's static resolution has been compromised in order to improve its lag and burn-in weakness, we've listened to what you had to say and have actually increased the Plumbicon's static resolution performance while maintaining its superior dynamic resolution characteristics.

BURN-IN: In the fast-moving, uncontrolled environment of ENG and location shooting, you *are* going to face extreme and unexpected highlights. Under these conditions, you *cannot* afford to run the risk of increased production costs while you repair "burned" tubes or, even worse, having no choice but to air live shots not up to your broadcast standards. You *can* rely on the superior highlight-handling capabilities of the Plumbicon.

Plumbicon tubes exhibit very little perceptible burn-in, especially in highlights. The Saticon, on the other hand, has a noticeable characteristic of "hanging-up" on bright highlights and tends to exhibit picture-sticking after a camera has been focussed on a scene for any length of time.

After making the comparison, broadcasters like yourself have made their choice a Plumbicon-equipped camera with which they can be assured of getting quality video with that extra measure of protection in burn-in, and of performance in total resolution and sensitivity which only the Plumbicon can provide.

We reaffirm our long-standing commitment to staying abreast of the needs of the broadcast industry...and to continue to supply the finest camera tubes that can be made. Amperex is dedicated to product excellence.

For more information, contact: Amperex Electronic Corporation, Slatersville Division, Slatersville, Rhode Island 02876. Telephone: 401-762-3800.



Amperex®

TOMORROW'S THINKING IN TODAY'S PRODUCTS

A NORTH AMERICAN PHILIPS COMPANY

Circle 123 on Reader Service Card

EIMAC's new high-mu triode/cavity combination. It takes the hassle out of 10 kW VHF transmitter design.

Relax. Now EIMAC offers you the best triode available and a cavity that has been custom designed for it. All you have to do is design them in.

The advantages are impressive. EIMAC's ceramic-metal high-mu triode (3CX10000U7) gives you peak sync power output of 10 kW and a stage gain of 14 dB. That's 2 dB more than with comparable tetrodes.

And there's more. Driving requirements are reduced; screen power supply and screen circuitry are eliminated; and cooling requirements are lessened. The result is ease of maintenance and substantial cost reduction.

There are two EIMAC cavities for your 10 kW combination, the CV-2240 for channels 2-6, and the CV-2250 for channels 7-13. For further information contact Varian, EIMAC Division, 301 Industrial Way, San Carlos, California 94070, (415) 592-1221. Or call any of the more than 30 Varian Electron Device Group Sales Offices throughout the world.



Circle 124 on Reader Service Card

MOVING INTO THE AUDIO 80s WITH THE RKO RADIO NET

The programming developed for the new RKO satellite-linked radio net and the top-level audio quality setup for the operation show some of the basic success factors for radio in the new decade. The rapid growth of the net, from a zero start in late 1979, shows that many radio managements accept RKO's prescriptions for the audio future.

WHEN GROUP STATION OWNER RKO wanted to expand radio operations in early 1979, its well-publicized difficulties with the FCC over license renewal stopped it from buying new stations at that time, and from upgrading its market weight by replacing some stations with others.

RKO's management, however, was hardly ready to pack it all in. It decided that an excellent way to stay in the radio business in spite of the serious license challenge would be to found a radio network to supply programming to other licensees. The plan's potential profitability stood up under management analysis, and RKO decided to go ahead with it.

To live up to its potential and stay on top of the radio future, the plan needed several key elements. It would be based entirely on a satellite feed; it would boast top audio quality; and its programming would be carefully aimed at the young adult listener, the 18 to 49 group, with material designed to fit smoothly into the local programming of radio broadcasters. RKO knew excellent audio quality was essential to give the "new kid on the block" a competitive edge — sound reasoning also when setting up a new station.

The idea bore fruit in October, 1979, with the inauguration of the RKO Radio Network. Active planning had begun early in the year, with the startup date originally projected for the spring of 1980. But the explosion in the satellite field convinced RKO that the earliest possible start would pay dividends. It advanced the date to January, 1980, and then pushed it to October, putting intense pressure on the building operation.

The speedup was aided by the Associated Press's pioneering plan which established a pattern for satellite operations for reaching affiliates. As described previously, AP plans to furnish each of its affiliates with an earth terminal and to distribute all standard programs via the birds. The AP earth stations are going in rapidly around the country, with about 400 scheduled to be in operation by the end of the year.

AP, knowing its satellite web would have unused spectrum space both in the sky and on the ground, started looking for other users that might want to share the system. RKO was already actively planning the radio net operation when AP made its share-or-bird offer. Negotiations led to a firm agreement assuring RKO a permanent place in the satellite channels AP had on long-term con-

tract. In addition, the deal gave AP affiliates the opportunity to subscribe to the RKO service, which they got by simply adding two additional demodulators (one for each stereo channel) to their AP-supplied earth terminals. (See "The Radio Earth Terminal: Entry To The Satellite Age," *BM/E*, May, 1980, for a discussion of satellite program selection methods in earth terminals.) A non-AP affiliate can get the RKO programs by installing an earth terminal and subscribing to the service.

RKO, as planned, started up with the 12 RKO radio stations as the only "listeners" in October — a first-class organizational achievement, of which more below. Active promotion of the net had started earlier and new affiliates came in during late 1979 and early 1980 at a satisfying pace. By early July more than 130 stations had signed up with RKO, a remarkable takeoff: the net was adding about two affiliates a week at that time. The management would like to have 250 to 300 stations by the end of 1981, and there is every indication it will achieve that goal.

Programming: a three-pronged attack

So RKO's gamble is a winner, and the nature of the effort is worth study as an important benchmark for the radio 80s. We look first at the programming, which is winning fast acceptance among radio broadcasters.

There are three main elements in this initial period (RKO may add more as the operation matures). The first is a 24-hour news service, with three-minute newscasts on the hour or half-hour, varying slightly from day to day. The second consists of 90-second mini-documentaries that RKO calls *Lifesounds*, bringing listeners information on all aspects of their personal lives as well as such topics as science and entertainment. Recent topics have included "The Sexes," "The Family," "Record Review," "Money, Money, Money," "Science Shorts," "Movies," and a number of others. They can be slotted into the station's programming whenever and as often as desired. Many can be logged as public affairs; others are entertainment. A minimum of five segments per week are sent out; the number will increase later. The third element is a series of two-hour music specials in stereo, with six planned for each year in the immediate future.

Each element of the programming plays a carefully calculated role in helping the local radio station maximize

DYNAMIC NEW DIMENSIONS IN VISUAL PRESENTATION —with General Electric Professional Large Screen TV Projection

General Electric professional large screen television projectors—displaying color or monochrome pictures up to 25 feet wide—bring new dimensions of presentation impact to a broad spectrum of applications.

A wide choice of new and improved color and monochrome models is available to meet specific requirements for television display applications, in standard or high brightness, for various scan standards.

The color projectors utilize General Electric's exclusive single optical path light valve. All color information is projected simultaneously in one light beam. This system eliminates time-consuming registration of three separate images which is required for all other color television projectors.

These projectors can display any size television picture from two feet to 25 feet wide, with high resolution and contrast over their full range of light output.

Among the primary applications of the projectors are:
Medical and Dental Education, Technique and procedural training.

Business, Sales meetings, industrial training, product presentations, real-time display of computer-generated data, teleconferences.

Aerospace and Defense, Situation displays, simulator training.

Entertainment, Theatre television and closed-circuit TV events, overflow crowds, discotheque special effects.

Television Production, Backgrounds for news programs, special effects, data display, program previewing.

Call or write: General Electric Company, Video Display Equipment Operation, Electronics Park 6-206, Syracuse, New York 13221. Phone: (315) 456-2562/2533/2179.



IN THE BOARD ROOM: At Mellon Bank N.A., Pittsburgh, General Electric color projector displays data, graphs, and information programs.



IN EDUCATION: General Electric color projector gives students the big picture of minute detail at Upstate Medical Center, Syracuse, New York.



IN BUSINESS: General Electric projectors display real-time computer-generated data for Merrill Lynch Government Securities, New York.

GENERAL  **ELECTRIC**

Circle 132 on Reader Service Card

RKO Radio Net

its appeal to listeners and advertisers. The newscasts, for example, are written especially to fit the needs of the young adult target audience. The bombastic "this is the network" sound is strongly avoided, and the tone is informal, with material written to emphasize how the news affects the listener personally. Newscasts cover both national and international news, selected at all times to fit in with this "personalization."

A large headquarters news staff, with stringers in cities around the world, and news bureaus in New York, Washington, and other cities, gather the news and prepare it for broadcast. In addition, affiliates can feed their coverage of local events into the system (and get paid for doing so). The staff of news editors and on-air personnel, now numbering about 12 in RKO's newsroom, have been thoroughly trained in the net's news style; this staff is slated to grow.

RKO's Los Angeles station, KHJ, produces the music specials, each one devoted to a top rock or pop music group. Wings, the Eagles, the Spinners, Donna Summer, and Paul and Linda McCartney have already been featured. The rationale for the specials (besides satisfaction for the listeners) is to give stations the chance to promote "something extra" that will attract new listeners. The station gets to sell time at a premium rate, and also gets an audience enlargement factor.

The plant: from the ground up

The plant RKO built is designed to produce the specific elements of the programming efficiently. RKO wanted a main base for the network at the organization's New York headquarters at 1440 Broadway, just south of Times Square. The first plan was to vacate office space the group already had, installing facilities gradually as space could be cleared. The excellent studios of RKO's WOR and WXLO, in the same building (see *BM/E*, June, 1979), could fill in the holes until the network plan was complete.

But luck was on the RKO side here: another tenant in the building decided in short order to vacate the entire fifth floor. The group gratefully took the floor and started to build the entire production plant for the network all at one time, from zero. RKO got possession of the empty space in June, 1979; the network went on the air from a completed plant about four and a half months later. Engineering director Joseph Maguire, who gave *BM/E* a tour of the plant, called the construction period one of the most "intense" of his whole life, but said it was highly successful.

The design came from the RKO engineering department, with Pacific Recorders and Engineering as collaborators and design consultants. Architecture was by R.A. Hanson Company of New York. Pacific Recorders' Jack Williams designed and built the special switching systems needed, and provided technical integration of the whole plant, including the design of the furniture for the studio installations.

There was no doubt on the part of the top RKO management that the audio plant must have quality standards right up to the state of the art, including stereo capabilities throughout the plant, even in the newsroom. Top quality starts, of course, with the audio consoles. All are from the BMX series of Pacific Recorders, and have response within 0.5 dB to 20 kHz, distortion below the noise level

of excellent testing equipment, and the signal-to-noise ratio we have come to expect in the last few years from the very best consoles.

The other equipment also maintains a very high quality level. There are 12 Technics SP-10 turntables, 23 MCI two-track, four-track, and eight-track tape machines, a battery of AKG condenser microphones, and no less than 63 brand-new Tomcat cart machines, introduced by Pacific Recorders at the NAB show in April. (See the June "Show-in-Print" for a report on this new cart system.) Joe Maguire finds their quality remarkable: "it's a new ball game with carts," he told *BM/E*.

Carts are used for actualities and other recorded insertions of every kind in newscasts, with the RKO newscaster always live on the air. Open-reel tape is used for original recording of incoming material, including editing and production of the stereo music specials. The disc playing inputs can add any kind of disc-recorded material to newscasts.

The special character of the news means that a large, efficiently equipped news production area is needed. As shown on the floor plan, the newsroom is the largest single space, with positions at a central desk for up to eight news editors to prepare copy. Each position has access to a variety of inputs. One position has a built-in tape deck and other facilities for recording material and making a preliminary edit.

Final editing of news into recordings to be used on-air is done in the two edit rooms at the left end of the newsroom. Each room has a full control console and complete editing capability on both open-reel and cart machines, together with microphone inputs. In a pinch, either of the edit rooms can go on the air.

But putting the news on the air (i.e., sending it to the satellite) is regularly carried out in one or more of the complex of three control room/studios that take up a good part of the left side of the floor plan, as shown. The three rooms are set up so that any one can be used singly for on-air work. They can also work together, with Control 1 acting as a master control (with a news producer in charge); the "studio" with recorded material to go in the newscast; and the "air studio" with the live anchor or commentator.

The plant also makes efficient provision for the production of the *Lifesounds*. For this series the plant has the



Chief engineer David Pollard makes adjustment in terminal room of new RKO network plant. Racks hold audio processing and amplifying equipment, cart and reel players, patch panels. Room can go on air if needed

RKO Radio Net

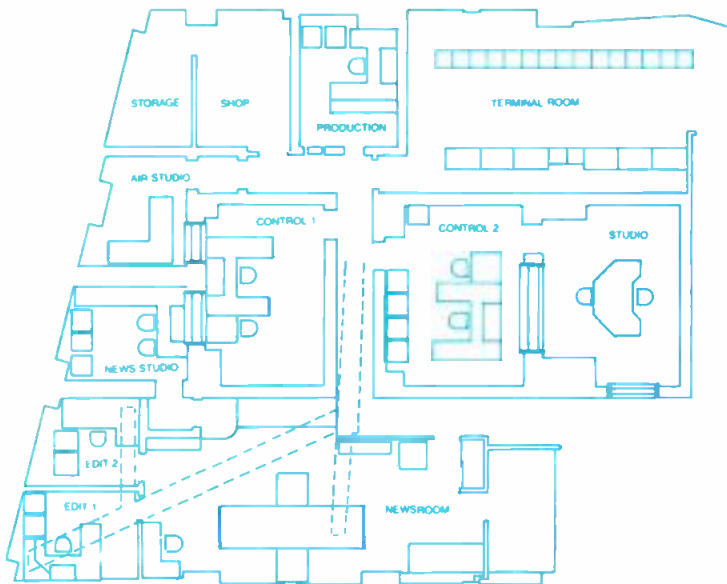

Newsroom, across lower section of floor plan, has central operating space for eight newsmen, two editing rooms at left end for final production of newscasts. Other spaces are for putting programs on air, talk shows, etc.

large studio at right center, with the adjoining Control 2. The studio has the traditional comfortable seating around a table with a multiplicity of microphone inputs; one or several guests can be interviewed and the material recorded for editing later.

There is an additional production room (top center on the plan) with complete input and recording facilities: disc inputs, reel-to-reel and cart tape machines, control console, and microphone inputs. This second production area allows a second program to be produced while one is in process in the large studio and control room. It can also function as the editing and production room for the music specials. As already noted these get original recording at KHJ, Los Angeles, with the tapes brought to New York for final preparation. The room can go on the air if necessary.

The terminal room, into which all incoming and outgoing lines feed, holds in its rows of racks the amplifying and control equipment for the whole plant. It has audio processors of several kinds available "on call" for cleaning up difficult recordings; it has both open-reel and cart machines, a control console, and it too can go on the air in a pinch. Some of the other equipment in the plant, in addition to that listed already, are several Multilimiter compressor/limiters from Pacific Recorders; JBL 4313 monitor speakers for all monitoring areas; Orban equalizers, and Stanton disc pickups.

Switching system covers all bases

The plant is organized on a "four-main-line," four-bus switching system, with one through line for each of the four time zones, so that material can be slotted at the right local time for affiliates across the country. A switching system, repeated at every control position throughout the plant, allows any of 16 inputs to be fed to any of the four zone-lines. This switching system, designed and built by Pacific Recorders, presents to the operator four rows of 16 buttons each. It has an automatic interlock circuit: when one program is feeding a line, the user can push a button to make the line unavailable to any other user.

Another plant-wide switching system is an "X-bar" that brings to each control position and to all editing positions in the newsroom a series of 20 inputs for selection. Among them are all the signals being handled in any part of the plant, plus a range of outside sources. The system is much the same as the "X-bar" system installed in RKO's New York WOR, as described in *BM/E*, June 1979.

As the floor plan shows, the plant is compact: it is smaller in area than the studio setup of some large broadcast stations. But it is extremely well equipped for the job it must do. In spite of having a very large complement of equipment at work, the plant is not crowded; Joe Maguire terms it easy to get around in and to use.

Technical flexibility is further enhanced by having a series of patch panels at control positions throughout the plant. These are not used in regular operations, which are thoroughly covered by the console switching and special switching systems. The patch panels make possible any unusual grouping or routing, and also provide quick access to every important unit and line in the plant for test or analysis.

Jack Williams pointed out how the design takes advantage of another opportunity that was provided by building from scratch. Throughout the plant signal levels, impedances, and frequency balances are all very closely standardized on lines feeding inputs and outputs. Anything can be connected to anything else without any worry on matching problems. New units go in to replace old ones with no adjustments needed. It is another important factor in maintenance of the plant's top-grade quality.

Maguire explained that one major element of the plant is still to come: a computer that will carry out the switching, allowing for a variety of special effects in program handling, such as automatic crossfades. Cabling is already in the floor for the computer, which will go in at a later date.

The RKO plant obviously puts out a state-of-the-art signal. What happens to it on the way to the listener? The satellite circuits, of course, maintain a high quality — according to Maguire, the signal that reaches the user's studio has a signal-to-noise ratio in excess of 60 dB, and the distortion stays very low through the satellite electronics.

To help the local station pass the quality on to the listener without degradation, RKO sends out 24 hours a day, whenever a program is not on the feed, a repeating series of step tones that go rapidly through the audio spectrum, all at a carefully maintained equal level. The affiliate's engineering personnel do not have to call RKO to send out a test signal: it is always there. The signal goes out in carefully phased stereo, so that the receiving station, with an oscilloscope or spectrum analyzer on the studio output, gets a rapid check on phasing as well as frequency response.

What does the remarkable quality of RKO's plant mean to a radio station subscribing to the programming? It means that if the station's engineering department does its part, the station can air a signal that will be technically competitive far into the Audio 80s. For the past several years many voices in the industry have been urging radio managements, those that have not already done so, to clean up their audio and bring it into the New Era. The RKO radio net, among its other results, furnishes radio managements with one more incentive for joining the high-quality age.

BM/E

Collins SVR-4 receivers go to extremes: Reliability way up. Price way down.

All three of our new low-priced SVR-4 satellite video receivers have features in common — plus reliability that's very uncommon. (Write us and we'll send you our test results: 30,000 hours mean time between failures.)

All three receivers are designed for reliable wide-band video carrier reception from international and domestic C-band satellites. All are EIA RS-250B and CCIR Rec. AA compatible; have two video outputs plus composite video and subcarrier output; and have three standard audio subcarrier frequencies.

They also share these features:

- A threshold extension technique that improves audio and video performance when operating with a low carrier-to-noise (8.0 dB C/N).

- Alarm circuits that monitor the audio subcarrier, video, and RF level. A summary alarm contact closure, as well as front panel LED indicators. Internal logic prevents a summary alarm for a loss of transponder carrier.

SVR-4A-1, our frequency agile 24-channel receiver, is our most versatile model. It has a front panel local channel selector and a rear chassis BCD interface for remote selection. Channel designation matches the RCA satellite frequency plan. Odd numbered channels match the 12-channel frequency plan.

SVR-4T-1 is manually tunable for continuous operation over the total 3.7- to 4.2-GHz frequency band. Tuning is provided by a front panel knob with channel indicator.

SVR-4F, our low-cost single-channel receiver, can be retuned to any channel in the field — without special tools or test equipment.

Backed by Rockwell's warranty and service, these receivers are available for quick delivery.

For further information, contact the Collins Transmission Systems Division, Rockwell International, Dallas, Texas 75207. Phone: 214/996-5340.

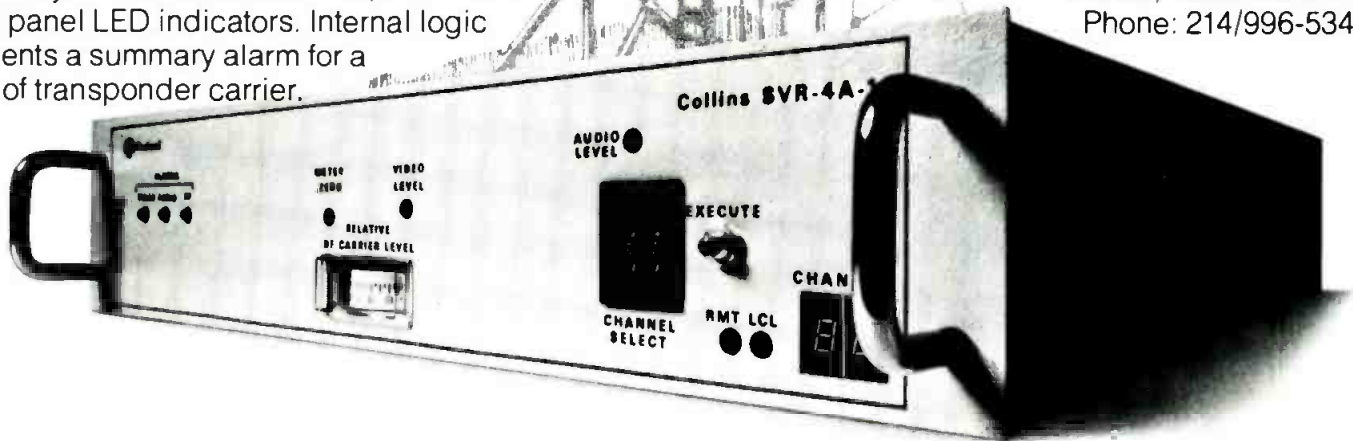
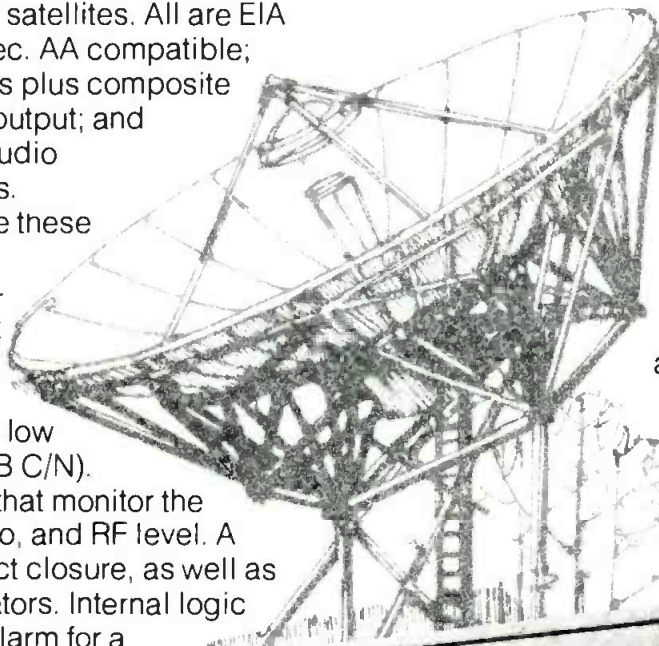

...where science gets down to business

Atlanta, Ga. (404) 979-0888 • Denver, Colo. (303) 978-9600 • Galion, Ohio (419) 468-3964 • Independence, Mo. (816) 737-3033 • Minneapolis, Minn. (612) 835-4989
Redwood City, Calif. (415) 365-3364 • Rock Hill, S.C. (803) 366-7428 • Old Saybrook, Conn. (203) 663-2571 • Tallahassee, Fla. (904) 877-2580 • Arlington, Va. (703) 685-2661

Rockwell has the latest words in communications: Collins systems.

Brussels 242-4048 • Cairo 989358 • Rodgau (Frankfurt) 671 • Hong Kong 5-274-321 • Kuala Lumpur 27283 • London 01-759-9911 • Manila 86-63-22
Melbourne (Lilydale) (03) 726-0766 • Paris (Rungis Cedex) 687-31-02 • Reading, England 61111 • Rio de Janeiro 286-8296 • Riyadh 476-9060 • Rome (0) 6-862-415 • Seoul 74-8470
Tokyo 265-8820 • Toronto (416) 757-1101

Circle 125 on Reader Service Card

www.americanradiohistory.com

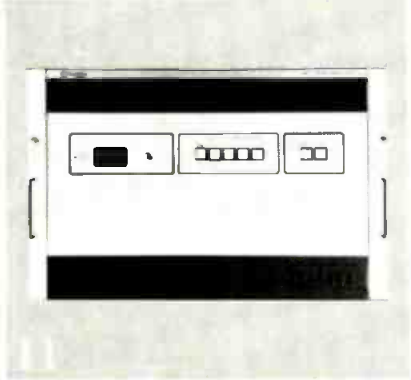
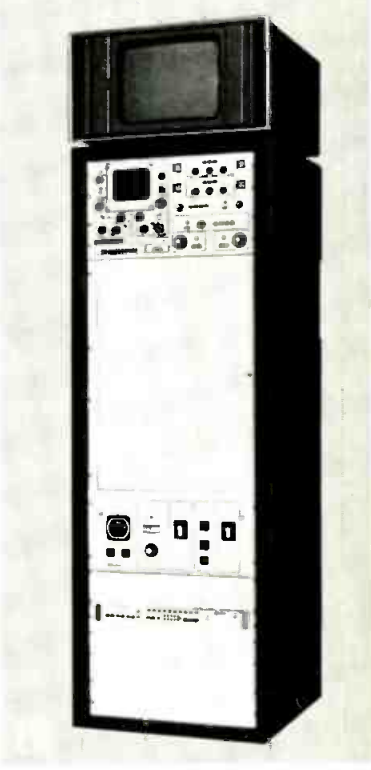
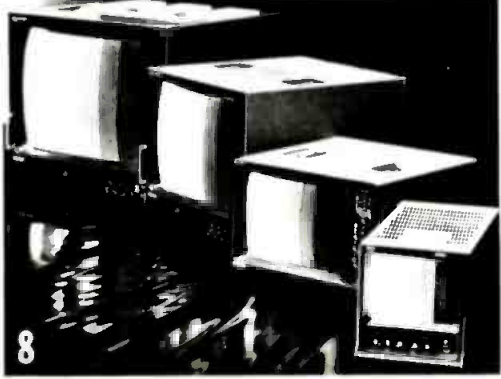
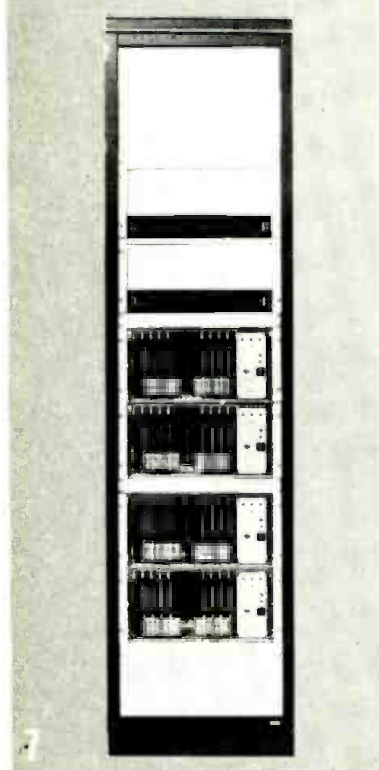
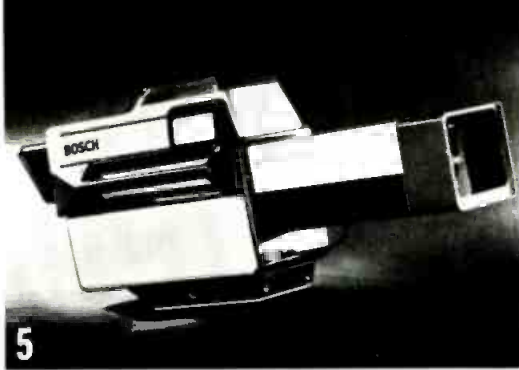

The most comprehensive family of products now offered to the broadcast industry.

VTR's. Superb Bosch mechanical engineering provides 1-inch interchange and multi-generation performance that is unsurpassed. Shown (1 at left) are the reel-to-reel portable BCN-20, the reel-to-reel studio recorder BCN-51, and the world's first automatic multicassette machine with 16 hours of continuous playback: BCN-100. Also in the BCN family is the unique BCN-5, 18 lbs. lighter than any other 1-inch portable. (2)

Mach One™ Computer-Assisted Editor. By any comparison, Mach One's keyboard requires the absolute minimum number of keystrokes for all operations, which include special effects and auto assembly. Controls up to six VTR's. (3)

Cameras. A complete line including the new KCA-100 ENG camera with state-of-the-art sensitivity, resolution, and signal-to-noise performance (4); the KCP-60 production camera with the optimum blend of high performance and low price (5), and the top of the line, fully automatic KCK. (6)

Distribution Switching. The TVS/TAS-1000 series, with the latest in alpha-numeric controls for easy, error-free operation, has set a standard around the world for compact design and reliability. Building-block matrix concept for configurations from 10 X 10 to 100 X 100 and beyond. (7)

Monitors. No less than twenty models, from 25-inch color to 9-inch monochrome; three performance/price classes; cabinet and rackmount; all color standards. (8)

Telecine. Fixed or variable slow motion speeds, forward and reverse, as well as fast motion up to 25 times normal speed is now possible with the revolutionary FDL-60 CCD Telecine. (9) And for the economy and input flexibility of vidicon film chains, the TCF-3000 Telecine Camera. (10)

Noise Reduction. Up to 18 dB signal-to-noise improvement, plus image enhancement and chroma-to-luminance delay correction with the TDF-2 Digital Noise Filter. (11)

Graphics Systems. The software-based Composer I™, with full function dual channels, offers push-button access to over 100 font styles and the largest memory of any machine of its kind. (12)

For detailed information on the Fernseh family of products, including machine control systems, sync generators, optical multiplexers, processing amplifiers, color encoders, and a complete line of video, audio, and pulse distribution equipment, write or call Fernseh Inc., P.O. Box 15068, Salt Lake City, Utah 84115, (801) 972-8000.

*For literature only, call 1-(800)-821-7700, Ext. 701
In Missouri, call 1-(800)-892-7655, Ext. 701*

FERNSEH INC.

*the Video Corporation of
Bell & Howell and Robert Bosch*

Circle 126 on Reader Service Card

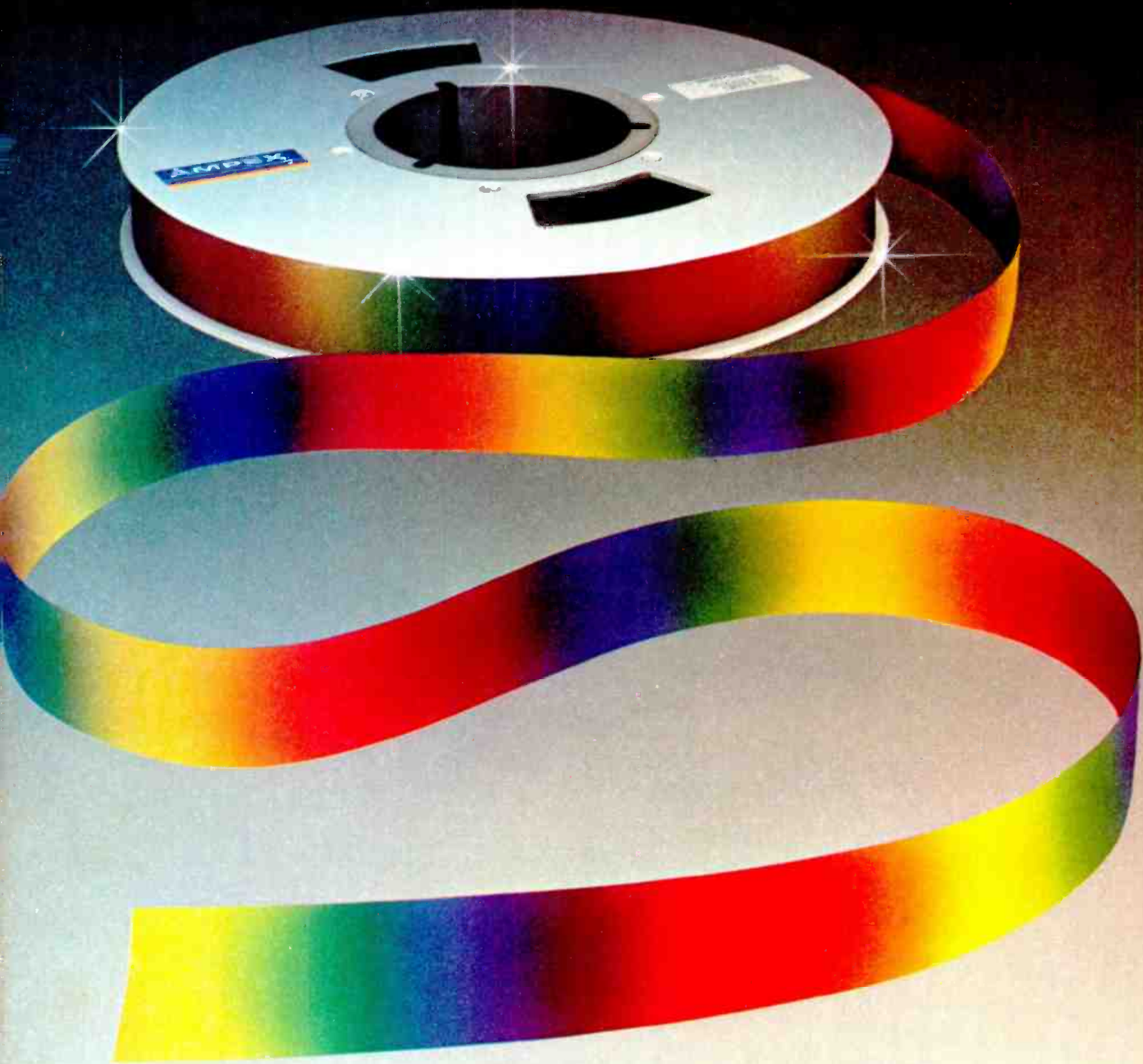

STATE OF THE ART

AMPEX 196 SERIES BROADCAST 1" HELICAL TAPE

This is the tape Ampex *had* to design to demonstrate the fantastic capabilities of our VPR Series 1" helical videotape recorders that is revolutionizing professional video recording.

With Series 196, color brilliance is preserved and signal-to-noise-ratio is unaffected even after multiple playback passes, lengthy still framing and heavy post-production editing. This tape is the ultimate match for the VPR-Series video recorders—a

brilliant combination that is unsurpassed in today's video recording industry. Available in SMPTE Type "C" or "B" formats. 34 min/66 min/94 min.

Contact Ampex Corporation, Magnetic Tape Division, 401 Broadway, Redwood City, CA 94063, 415/367-2011.

AMPEX

Circle 128 on Reader Service Card

CCD CAMERAS: COUPLED WITH THE FUTURE

With several recent introductions of small CCD-based cameras for industrial and consumer markets, broadcasters are wondering how much longer they will wait for those ultra-small cameras to reduce their burdens. Progress is being made in the solid state sensor field, but a viable broadcast-quality CCD camera is still some time off.

SOMEWHERE IN THE COLLECTIVE IMAGINATION of nearly every ENG crew resides the image of a tiny color TV camera, about the size of the wind-up 16 mm they were used to. The real dreamers on the crew even imagine that this tiny little camera contains a VTR. Of course, such a dream is not unrealizable and as readers of last month's *BM/E* will recall, Sony did in fact show a developmental model of such a camera/VTR unit. Sony, of course, showed the camera as part of an appeal to other manufacturers to "come to terms" on establishing a standard recording format for this class of camera, intended for the consumer market.

The Sony "Video Movie" unit, as they labeled it, and the various other CCD (charge coupled device) based cameras are not broadcast quality. According to manufacturers and engineers working on CCD camera products, the major drawback to higher quality CCD-based systems are the CCD chips themselves. Currently they fall short of resolution and "cosmetic" characteristics expected in broadcasting. Moreover, the geometry of solid state cameras would require new optical designs to accommodate the shorter back focus of such solid state image sensor arrays. Few of the engineers and manufacturers expect the required higher quality CCD chips to become available in sufficient quantities to produce a cost-effective solid state camera in less than three to five years.

Nevertheless, the advances in current CCD camera technology are worth taking a look at. Sony, RCA, NEC, Hitachi, and Matsushita (Panasonic) have all made small CCD cameras available for industrial and/or consumer markets. Most of the cameras are color capable and extremely small. Differences exist largely in the image sensing designs.

RCA believes that a multiple array of three CCDs is most promising. Others have opted for single sensor approaches. According to Robert L. Rodgers, III, manager of RCA's Closed Circuit-Video Equipment Engineering, Systems, and Equipment operation, where development of RCA's solid state camera is going on, there are several standard approaches to solid state designs. The Charge Transfer approach involves the transfer of the image to readout circuitry; the X,Y-Addressed approach involves X, Y sensors which sample the stored charge at the coincidence of a row and a column address. A recently tried

approach involves the use of a photoconductive layer similar to that commonly used in vidicon tubes.

According to Rodgers, the vertical frame transfer CCD (a subdivision of the Charge Transfer approach) has the best combination of performance parameters, which include optical overload characteristics; blue sensitivity; fixed pattern background and shading; optical aliasing and moire; and cost.

RCA's CCD camera made a brief but dramatic broadcast appearance when footage it produced was used on a PBS-aired National Geographic special, "Dive To The Edge of Creation." The CCD camera had been specially adapted to fit into a 4-inch diameter housing capable of withstanding pressures of 20,000 pounds per square inch. Used by a scientific team exploring the ocean's floor some 9000 feet below the surface, the CCD camera produced vivid pictures of life forms never before seen.

Robert L. Rodgers described the CCD camera developments in a paper prepared for RCA. "The specific device described is a 512-element (vertical) by 320-element (horizontal) sensor. The image area of the sensor which is used to create the charge pattern" is one-half the surface area of the device (Fig. 1). "The charge pattern replicating the image is collected in the image area during



RCA technician Fred Engle makes final adjustments to mount holding the CCD camera on the mechanical arm of Alvin, before the Woods Hole research submarine is launched from its mother ship, Lulu, to probe the Galapagos Rift at the bottom of the eastern Pacific

PHILIPS®

Presents **World Class TELEVISION**



The internationally recognized cameras and broadcast equipment preferred by broadcasters, production companies and industry around the world:



LDK-14

The years-ahead 2/3-inch field and studio camera family. Now with triax capability.



VIDEO 80

Modular camera and expandable production system in Broadcast and Institutional use around the world.



LDK-25B

Newest version of the World Class, state-of-the-art LDK 25/5/15 camera family. With innovations used by ABC in exciting coverage of the Winter Olympics.

Plus... a wide array of innovative World-Class products like:

Transmitters and Exciters

Fastest growing UHF/VHF transmitter line in North America.

Video Tape Recorders

1" type C, system and stand-alone.

New, Time Code Generator

SMPTE, PAL, SECAM rates, and film... 24 frames per second!

Tape Synchronizer

Television audio post production.

Digital Noise Reducer

Fully automatic.

New, Synch and Timing System

Built around ultra-stable Philips SPG sync generator.

Test and Measuring Equipment

Modulators, demodulators, VITS analyzer & generator, and new waveform monitor and vectorscope.

New, Teletex

Text display system component.

Contact your Philips representative today, indicating product interest, or call Philips Broadcast Equipment Corp., 91 McKee Dr., Mahwah, N.J. 07430. (201) 529-3800.

PHILIPS® *Innovative Leader in World Television*

Circle 129 on Reader Service Card

www.americanradiohistory.com

CCD Cameras

the time taken to display one field of the picture on a TV receiver (approximately 16 msec). During the vertical blanking interval, the charge pattern is transferred to the storage area. This erases the image area and prepares it for the next exposure. The pattern in the storage area is loaded one line at a time into the horizontal readout register." The horizontal register is clocked at 6.1 MHz to read one line of information. The output circuitry located on the chip converts the charge pattern into low-impedance output voltage which interfaces with the video processing circuitry (separate from the chip). This approach is generally referred to as a "bucket brigade." After the charge is transferred to the output circuitry, the makeup of the camera is essentially similar to current video cameras.

Another area of concern is blue light sensitivity for CCDs. The standard CCD image sensor is the SID 52501, which uses a polysilicon gate structure. According to Rodgers' paper, the charge pattern is formed in the sensor by imaging through the polysilicon electrodes. In the infrared portion of the spectrum the gate electrodes are transparent and the sensor response is determined by absorption in the substrate. In the blue and green portions of the visible wavelength region the polysilicon electrodes become more absorbent, resulting in a serious decrease in efficiency of the blue sensitivity. Newly developed CCDs have greatly improved this characteristic and have led to the rash of marketable CCD cameras.

How many CCDs

Several CCD cameras have made appearances recently at industry gatherings, including this past NAB convention in Las Vegas. The CCD camera that RCA brought to NAB utilized three CCDs to make up its imaging apparatus. Each CCD consists of a matrix of 512 by 320 elements providing an array of 163,840 elements. Prism optics split the light into RGB, with each sensor handling one of the primary colors. The image area of the RCA design has a 12.2 mm image diagonal, slightly larger in format than a 2/3-inch vidicon tube. According to RCA, most currently available single CCD chips have fewer than 50,000 elements available.

Sony is currently marketing a two-CCD camera to the industrial market, its XC-1, which weighs 2.8 pounds. The picture format of the unit is that of a 2/3-inch tube; the sensing area is 88 microM, and the picture element count is 245 by 492. Signal-to-noise is better than 43 dB at f/2 with 500 lux. Minimum scene illumination is 100 lux at f/1.6 with a 33 dB S/N. Resolution for the camera is 280 horizontal lines and 350 vertical.

Sony's "Video Movie" unit, on the other hand, which was presented at a press conference in July, uses a single chip design. This chip is a frame transfer, narrow channel type CCD which provides 570 by 490 picture elements for a total of 279,300 elements. Again the image format is 2/3-inch. Minimum scene illumination is 70 lux, but at normal outdoor light levels, signal-to-noise is 45 dB. This camera weighs just 600 grams with lens and viewfinder.

Of course, the most exciting thing about Sony's prototype "Video Movie" unit is the presence of a built-in VTR. Weighing an additional 600 grams, the tiny VTR is integrated with the body of the camera much as consumer Super 8 cameras using film cartridges. The videotape recorder uses a cassette that measures just 56 by 35 by 13

mm, weighs 18 grams, and employs a high quality metal tape that measures 8 mm wide. Recording time on the cassette is 20 minutes.

The VTR itself uses a rotating head drum, helical scan, FM, azimuth recording system. Horizontal resolution is 250 lines and signal-to-noise is rated at 45 dB. The unit consumes three watts and is powered by a 9 V battery. The total weight of the combined camera/VTR unit is approximately 4.4 pounds.

The "Video Movie" system also includes a separate Home Editor unit used for playback of the recording. This standalone unit plugs into any standard home VCR for transfer and/or editing of the recorded sound and picture. The camera's VTR transport is used by the Home Editor for this purpose. When a recording has been made, the camera body snaps onto the Home Editor. The Home Editor can be used with a home VCR as mentioned earlier, or playback can take place directly through a standard television receiver using an RF connector.

While Sony chairman and chief executive officer, Akio Morita, emphasized that the "Video Movie" unit is intended for the home market and unlikely to be ready for market before 1985, the implications for the broadcast market are clear. Though the quality of the "Video Movie" unit is far below that required for broadcast use,



Hitachi's M.I.D. camera uses a 3-MOS plate design that delivers a 46 dB signal at 200 lux

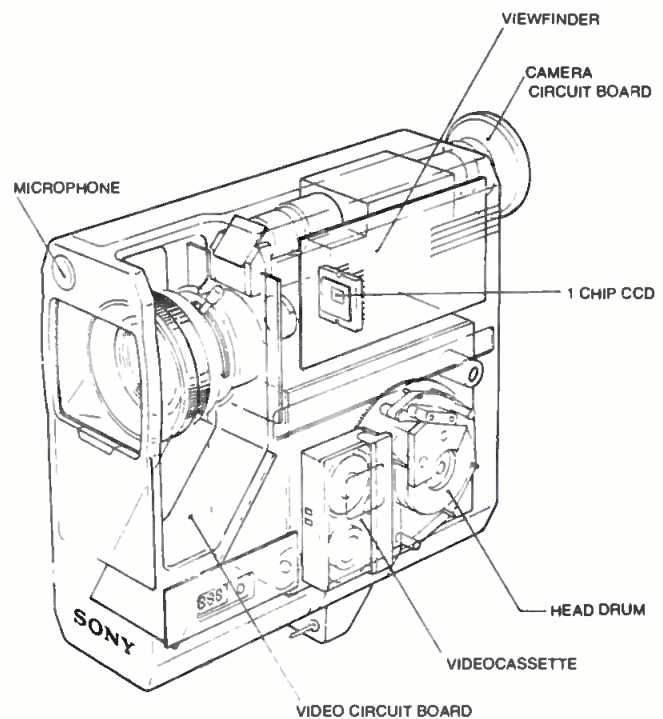

Sony's "Video Movie" unit provides a glimpse of things to come; ultimately an integrated, one-piece VTR/camera

**“Ready when
you are C.B.”**



Christie - The “Burping” Charger/Battery System That Does It In 20 Minutes or Less.

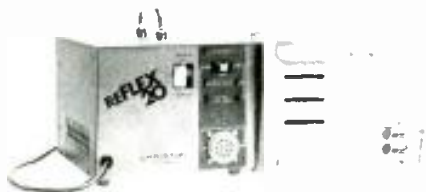

Whether you're shooting a full-length

documentary or news gathering for the evening wrap-up, you need a battery/charger system that's ready when you are. Christie has the only ni-cad battery pack that's completely rechargeable in 12-20 minutes. The REFLEX® 20 Charges and sempiternal battery packs provide 90-97% efficiency, while extending battery life up to 10 times longer than other ni-cads and 50 times that of ordinary batteries. That's state-of-the-art technology backed by Christie's 51-year reputation for excellence.

When time is money, keep your cameras rolling with the REFLEX 20 from Christie.

SINCE 1929
CHRISTIE
ELECTRIC CORP.

20665 V Manhattan Place
Torrance, California 90501
(213) 320-0808
FAX 910-349-6260
(800) 421-2955

1929—1980
51
YEARS
THE SOURCE

Circle 130 on Reader Service Card

CCD Cameras

the concept is clearly the dream of every ENG crew come true. Certain non-NTSC schemes for obtaining highband color from small format VTRs have already been demonstrated by companies such as Cezar International, Recortec, and Merlin. While the applicability of such highband techniques to the tiny Sony VTR is unclear, the confluence of technical developments clearly points to a day when such broadcast-quality systems should be realizable.

Another CCD camera represented at the NAB was Matsushita's (Panasonic). This camera uses a single chip made up of photoconductive silicon layers. The manufacturer claims that its design virtually eliminates blooming, which has been a problem with some CCD-based cameras. This design can suppress blooming to a level 120 times higher than the saturation exposure.

Developed at Matsushita's Central Research Laboratories, the solid state image sensor has 506 vertical elements by 413 horizontal elements for a total element count of 210,000. Standard scene illumination with an f/2 lens requires 500 lux. The unit's limiting resolution, at 280 horizontal and 480 vertical lines, provides the highest resolution yet for a camera of this type.

The main body of the camera is about one-third the volume of conventional tube-type cameras. It measures 10 cm high by 6 cm wide, and 11.6 cm deep excluding the lens. With the 6x zoom lens, the camera weighs 1.2 kg. Signal-to-noise at 500 lux is rated at 43 dB.

The sensor panel of the Matsushita camera consists of a photoconductive "Newvicon" layer, a transport area which employs both a BBD (Bucket Brigade Device) for vertical scanning and a CCD for high speed horizontal scanning. This unique construction, according to the manufacturer, not only expands the photoconductive area (improving its sensitivity), but also enables the surplus photoelectrons to be controlled, resulting in the ability of the camera to provide superior blooming suppression. A Mosaic filter is used for the coloring system.

Hitachi's entry into the solid state camera field is their M.I.D. unit, which uses a 3-MOS plate design. Hitachi says that the camera's 46 dB signal-to-noise ratio at 200 lux gives it the highest sensitivity of any solid state camera on the market. The camera provides an H & V resolution of 350 lines, and measures 70 by 129 by 165 mm including the lens. The camera, which is still in development, is intended for the industrial/educational market.

In addition to the color CCD cameras, both RCA and NEC have introduced black and white CCD cameras to the marketplace. RCA's camera has been available for several years, while NEC's camera was introduced at the recent NAB convention. NEC's T1-1000 has an S/N of 46 dB and consumes just four watts from a 12 V dc source.

While ENG crews will continue to only dream of tiny CCD cameras for the next few years, conventional cameras continue to improve quality, placing the design demands on solid state approaches even higher. Nevertheless, the eventual emergence of such cameras seems inevitable. Whether such cameras eventually include an integrated VTR or not, or opt for some type of wireless configuration, remains to be seen. Progress is substantial and constant. Development of solid state imaging devices will one day realize the dream.

BM/E

Quality

is the only language we speak!

No matter where you are, performance is the one standard common to professional broadcasters the world over. Ampro/Scully has established a reputation for providing a complete line of professional studio equipment with service and sales outlets locally available.

Scully Tape Recorder/Reproducers, Rotary & Linear Fader Audio Consoles, Cartridge Tape Recorder/Reproducers, and Three-Deck Cartridge Recorder/Reproducers.

For detailed product literature, write to us on your letterhead.

Dealer inquiries invited.



AMPRO  **Scully**

Professional Equipment for Broadcasting Professionals
826 NEWTOWN-YARDLEY RD., NEWTOWN, PA 18940
(215) 968-9000 • TWX 5106672299 • CABLE AMPROSCUL NTOW

c. 1979 Ampro Scully U.S.A.

Circle 131 on Reader Service Card

THE SOURCE: BUYER'S GUIDE TO THE BROADCAST INDUSTRY

WELCOME TO THE SOURCE 1980! *BM/E* has compiled the most current, complete listing possible of manufacturers and independent representatives and distributors serving the broadcast industry — a useful everyday guide to everything the broadcaster needs.

A unique feature of *The Source* is the VS — verified source — listing, granted only to companies that have provided *BM/E* with current information confirming that their products are regularly available. Verified sources are indicated by a VS in the manufacturers' listing and by a ♦ in the Instant Source Locator.

The Source has three parts: The Instant Source Locator, listing products by major category and subcategory; an alphabetical listing of manufacturers with addresses, telephone numbers, and product line descriptions; and a state-by-state directory to independent reps and distributors. To use the guide, look up the desired product in the ISL. Wireless mics, for example, are number 4 under the microphone heading in the Audio section. Note each company name followed by a 4 and locate these firms in the alphabetical listing. If the firm's description refers you to the rep/dist list, check the boldface cross references there for the nearest local source.

Advertisers' names appear in red; consulting the ad can provide useful details on a product or company.

Whatever you're looking for in broadcasting, you'll find it in *The Source 1980*. Remember — the VS in the alphabetical listing or the ♦ in the ISL assures you that the products you're looking for are regularly available from the manufacturer. It's verified!

INSTANT SOURCE LOCATOR

I. Audio Equipment	52
II. Video Equipment	55
III. Film Equipment	60
IV. Lighting	60
V. RF/Transmitting/Receiving Equipment ..	60
VI. Antennas/Towers/Transmission Lines ..	62
VII. Test & Measurement/Monitoring/Timing/Logging Equipment	65
VIII. Systems & Services	66
IX. Components/Hardware	68

I. AUDIO EQUIPMENT

Audio Amplifiers

1. preamps
2. line amps
3. monitor & power supplies
4. distribution amps
5. power supplies for amplifiers

Acoustic Research 3♦; ADM 1,2,4♦; Ailtech 3; Aitken 3; Allied Broadcast 1,4; Altec 1,2♦; American Data 3,4♦; Applied Technology 1♦; Arrakis 1-4♦; Ashly 1; Audio & Design 1,4♦; Audionics 1,3,4; Audio Techniques 3; Audio Technology 1; Avab America 2♦; Bayly 1-4♦; Bell Audio 1,3,4; BGW Systems 1,3,4♦; Bonneville 2,4; Boston Sound & Power 1-5♦; Bozak 1,3; Broadcast Audio 1-3♦; Broadcast Electronics 1,2,4♦; Cetec Broadcast 1♦; Channelmatic 4,5; Comprehensive Video 4♦; Crown Intl 1-4♦; Datatek 1-4♦; Delta (Long) 1-4♦; Di-Tech 4♦; Dunlap Clarke 1,3; Dyma 1,3,4♦; Dynair 1,4♦; Edco 4; Edcor 1,2,4; Eumig 1,2,3♦; Fernseh 3,4♦; Fisher Berkeley 5; Frequency Devices 5; Grass Valley 4♦; Gregg Labs 1; Hammond Ind 3; Harris 1-3♦; Heath 1,3♦; Hedco 2,4♦; Holland 1-3; Image Video 3♦; Intl Nuclear 1-4; ISI 4♦; ITI 1-3,5♦; Ivie 1,3; J&D Electronics 3,4; Johnson 1; James B. Lansing 1-4♦; Lauderdale 1,4♦; Logitek 1,2♦; LPB 1,4♦; Marti 2,3♦; McCurdy 2-5♦; McMartin 1♦; Merlin 3♦; Micro-Trak 1,4♦; Modular Audio 1-5♦; Multidyne 2,4,5♦; National Electrolab 3; Rupert Neve 4♦; Nikko 1,3♦; Opamp Labs 1-5; Orange County 3-5♦; Pacific Recorders 4♦; Panasonic 1,2♦; Paso Sound 1,2♦; Protech Audio 1-5♦; QRK 1,2,3♦; Quad Eight 1-3♦; Radio Systems 1,3♦; Ramko 1-4♦; RCA Broadcast 1,3,4♦; Research Systems 1,2,5♦; Richmond Sound Design 1,2,4,5♦; RMS 4♦; ROH 1-4♦; RTS Systems 1,2,4♦; Russco 1,2,4♦; SAE 1,2♦; Sansui 1,3♦; Scientific Radio 3; Scientific Systems 4; Sescor 1,2♦; Sharepoint 1,2,4; Sharp 3♦; Shintron 4♦; Shure 1,3♦; Lear Siegler 1-5♦; Sigma 4; Sontec 1,2,4♦; Spectra Sonics 1-5♦; Sphere 2; Stanton 1♦; Studer Revox 3,4♦; Superscope 1; Tandberg 3; Tangent 1-3,5♦; Tapco 3; Teac 1,5♦; Technics 1,3♦; Telemet 3,4♦; Television Prods 4♦; Telex 1♦; Thomson-CSF 4♦; TM Systems 2,3; Tri Tec 1-4♦; Tweed Audio 3,4♦; Ultra Audio 3,4♦; Uni-Sync 3; UREI 1,2,3♦; US JVC 1,3♦; Valley People 1♦; Vamco 4; Varian Electron 1,3♦; Versa Count 4♦; Vidair 1,5♦; Video Aids 3♦; VIF Intl 3♦; Vision Sound 3♦; Vital Inds 4♦; Ward-Beck 1-5♦; Wilkinson 2,4; World Video 3♦; Yamaha 3♦

Audio Controls
 1. rotary attenuators
 2. slide attenuators
 3. audio routing switchers

ADM 2*; American Data 3*; Audiotronics 2*; Broadcast Audio 2*; Broadcast Electronics 1,2*; Duncan 2; Dynair 3*; IGM 3*; ITI 1,3*; Kay Elemetrics, 1,2; Rupert Neve 2,3*; Oak 1; Opamp Labs 2; Pacific Recorders 1,2,3*; Penny & Giles 1,2*; Protech Audio 2*; Ramko 3; ROH 1,3; Sescom 1,2*; Shallico 1; Spectra Sonics 1,2; Superex 3; Tech Labs 1,2*; Telemet 3*; Texscan 1*; Utah Scientific 1,2,3*; Ward Beck 3*; Waters 1,2

Audio Processing Equipment
 1. ALC and AGC amplifiers
 2. compressor/limiters, AM
 3. compressor/limiter/filters, FM
 4. equalizers and filters, parametric
 5. equalizers and filters, graphic

ADM 3,4*; Altec 2,3,5*; AP Circuit 4,5; Applied Technology 1-3,5*; Arrakis 5*; Ashly 1-5; Audicon 4*; Audio & Design 1,5*; Audio Processing 4,5*; Audiotechniques 4,5; Audio Technology 1*; Avab America 5*; BEI 4,5; Bozak 4,5; Broadcast Audio 5*; Broadcast Electronics 1-3*; Caringella 2,3; CCA 1-3*; Coherent 1-5; Crown Intl 4,5*; dbx 1,2*; Delta 1,2*; Dolby 3*; Dorrough 2,3; Dyma 1-5*; Elcom 1-3; Elcom Specialty 1-3*; Eventide 2*; Frequency Devices 3,4; Gotham Audio 2-4*; Gregg Labs 1,2,3; Harris 1,3*; Harrison 4,5*; Inovonics 1-3*; Integrated Sound 5*; Intl Electro-Magnetics 5*; ITI 1*; Ivie 4,5; Kahn 4,5; Landy 2,4,5; James B. Lansing 2,3*; Lauderdale 1,5*; LPB 2,3*; Marti 1-3*; McCurdy 2,4*; McMartin 2,3,5*; Modular Audio 2,3,5*; Moseley 1-3*; MXR 3,4,5; Rupert Neve 2-4*; Nikko 2*; Opamp Labs 1; Orange County 1-4*; Orban 2-5*; Pacific Recorders 1*; Protech 1,2*; Pulse Techniques 4*; QEI 2,3*; Quad Eight 3-5*; Quintek 5*; Ramko 1*; RCA Broadcast 1-3*; Research Systems 5*; Richmond Sound Design 5*; SAE 4; Sansui 4,5*; Sescom 2-5*; Shure 3,4*; Lear Siegler 1-3,5*; Sontec 2-5; Sphere 4,5; Spectra Sonics 2,3,5*; Superex 4,5*; Superscope 4,5; Tangent 4*; Tapco 4,5; Teac 5*; Technics 4,5*; Thomson-CSF 1-4*; Transist-O-Sound 1*; Tri Tec 4*; TTE 3*; Tweed Audio 2,3*; UREI 2-5*; Valley People 2,3*; VIF Intl 1,5*; Ward-Beck 2,4*; Wavetek Rockland 4,5; White 4,5; Wilkinson 2,3; Yamaha 4,5*

Audio Special Effects/Reverb Units
 1. delay systems
 2. reverb, mechanical
 3. other special effects

Advent 1; Aitken 3*; AKG Acoustics 2*; AKG Sales 2*; Altec 1,3*; Audicon 2*; Audio & Design 1,3*; Bozak 1; Broadcast Electronics 1*; dbx 3*; Dyma 2,3*; ESC 1; Eventide 1,3*; Gotham Audio 2,3*; Ionic 3; Kappa 1; Landy 1,2; Lexicon 1-3*; Logitek 1*; Micmix 2,3*; Micro Communications 1*; MXR 1,3; Network Recording Prods 3*; Opamp Labs 2; Orange County 3*; Orban 2,3*; Protech 2*; QRK 2*; Quad Eight 1,2*; Quantum Audio 2*; Quintek 1-3*; SAE 1*; Sansui 2*; Ken Schaffer 1-3*; Spectra Sonics 1,3*; Synton 3*; Tapco 2; Ursa Major 1-3*; Variable Speech 2,3; Yamaha 1*

Automation Equipment
 1. sequencers, relay
 2. sequencers, time insertion
 3. controllers, computer/microprocessor
 4. complete systems

ABC Broadcast Controls 1-4*; Aitken 1,2*; Audicord 1*; Autogram 3*; Automation Techniques 1*; Boston Power & Sound 3,4; Broadcast Electronics 1-4*; BTX 3*; Cat Systems 3,4*; Central Dynamics 2,4*; Cetec Broadcast 3,4*; Channelmatic 3,4; Computer Concepts 3*; Consolidated Electronics 3; Crown Intl 3*; Di-Tech 3*; Dyma 3*; Fluke 3*; Harris 4*; Harrison, 3; IGM 2-4*; Image Video 3,4*; ITC 3,4*; 3M/Data Products 3*; 3M Video 3*; Microprobe 3,4; NEAS 4; Nidus 3,4*; PWH 4; Quad Eight 4*; Sharepoint 3,4*; Soll 3,4*; Sono-Mag 3,4*; Sound Technology 3*; Telex 1,2*; Torpey Controls 3,4; UMC 1,3,4*; Valley People 4*; Video Specialties 3,4; VIF Intl 1,4*; Vital Inds 4*

◆ MEANS VERIFIED SOURCE



Auto Time/Weather Announcers
 Broadcast Electronics*; Cavox-Tapeathon*; Hallikainen & Friends*; IGM*

Consoles
 1. mic mixers, one output
 2. portable
 3. studio, mono, multi-output (3 or more)
 4. studio, stereo, multi-output
 5. audio for TV
 6. automated consoles

ADM 3-5*; Altec 1-4*; Ampro/Scully 3,4*; Applied Technology 1,2*; Arrakis 1,3-6*; Audio Processing 2,4,6*; Audiotronics 2-5*; Audy Instruments 3,4*; Autogram 3-5*; Avab America 2*; Bayly 2*; Broadcast Audio 2-6*; Broadcast Electronics 1-5*; BSM Systems 2; Centro 2*; Cetec Broadcast 1,3-5*; Coherent 2-5*; Custom Audio 2,4; Dage-MTI 3*; Delta (Long) 1-6*; Dyma 2-5*; Hallikainen & Friends 5*; Hammond 4; Harris 2-5*; Harrison 1,3,4; Hedco 5*; HM Electronics 1*; Holland 1,5; Howe Audio 1; Image Devices 2-5; Integrated Sound 4*; Intl Nuclear 1-3,5; ISI 5; Landy 1,2,4; Listec 2,4,5*; Logitek 3-5*; Long, LPB 1,3-5*; LTM 2*; Magna-Tech 1*; Marconi 2-6*; McCurdy 1,3-5*; MCI 3-6*; McMartin 1-5*; Micro Communications 1*; Micro-Trak 2-5; Modular Audio 3-5*; Nagra 1,2*; Nakamichi 1*; Rupert Neve 1-6*; Nikko 3,4*; Norcom 1,2; Pacific Recorders 4*; Panasonic 1,2*; Protech 2-5*; Quad Eight 4,6*; Quantum Audio 1-5*; QRK 2-5*; Ramko 1-5*; RCA Broadcast 2-5*; Research Systems 3,4*; Richmond Sound 1-5*; RTS Systems 1,2*; Russco 2,3*; Sansui 2*; Shure 1,2,4*; Solid State Logic 6*; Sontec 1; Spectra Sonics 1-5*; Sphere 1; Studer Revox 2-5*; Tangent 1-6*; Tapco 1,3,4; Theatre Techniques 1; Transist-O-Sound 1,2*; Tri Tec 3-5*; Tweed Audio 1-5*; 2005 AD; Ultra Audio 2,3,5*; UMC 1,4,5* Uni-Sync 1,3,4; UREI 3-5*; US JVC 1*; Vision Sound 3,4,5*; Ward-Beck 3-5*; Wilkinson; Yamaha 1,4,5

Disc Playing Equipment
 1. turntables
 2. pickup arms
 3. pickup cartridges
 4. complete disc consoles

AKG Acoustics 3*; AKG Sales 3*; Astatic 3; Audio Technica 3*; Audiotronics 3*; Broadcast Electronics 1-3*; Cetec Broadcast 1-3*; Dyma 4*; Elpa 1; Gotham Audio 1,3,4*; Harris 1-3*; LPB 1-4*; Micro-Acoustics 3*; Micro-Trak 1,2,4; Nikko 1*; QRK 1,2,4*; Ramko 1*; Russco 1*; Sansui 1*; Sharp 1*; Shure 2,3*; Stanton 1,2; Studer Revox 1*; Superscope 1; Technics 1,2,4*; Vidair 3*; VIF Intl 3*; Yamaha 1*

Headphones
 AKG Acoustics*; AKG Sales*; Audiosears; Audio-Technica*; Audiotronics; Beyer Dynamic*; David Clark; Comprehensive Video*; GC Electronics; Harris*; Holland; Image Devices; Koss; Landy; Nakamichi*; Neal Ferragraph*; R-Columbia*; SAE*; Sennheiser*; Setcom; Stanton*; Studer*; Superex*; Television Equipment*; Telex*; US Pioneer; Vidair*; VIF*

Intercom Systems
 1. RF
 2. hardwired

Altec 2*; Avab America 2*; David Clark 2; Clear/Com 2*; Comprehensive Video 1*; Comrex 1*; Custom Audio 2; Dyma 1,2*; Fisher Berkeley 1,2; Harris 1*; Holland 2; Image Devices 1; Long 2; Marconi 2*; McCurdy 2*; Nova 2; Paso Sound 2*; Protech 2*; R-Columbia 1,2*; ROH 1,2*; RTS Systems 2*; Ken Schaffer 1,2*; Setcom 1; Sharepoint 1,2*; Lear Siegler 2*; Swintek 1*; Tangent 2*; Television Equipment 1,2*; Telex 1,2*; Theatre Techniques 2; Thomson-CSF 1*; Vidair 1,2*; Video Aids 2*

Microphones
 1. dynamic
 2. condenser/electret
 3. ribbon
 4. wireless
 5. shotgun
 6. lavalier
 7. stands, booms, dollies

Accurate Sound 7; AKG Acoustics 1-3,5-7*; AKG Sales 1,2,4-7*; Altec 1,2,6,7*; Astatic 7; Atlas Sound 7*; Audiosears 1; Audio-Technica 1,2,6,7*; Audiotechniques 7; Audiotronics 1,2,6; Beyer Dynamic 1-7*; Broadcast Electronics 1-7*; Bruel & Kjaer 2,7*; Cetec Vega 4,7*; Coherent 2,4,6*; Comprehensive Video 2,5-7*; Comrex 4*; Crown Intl 2*; Dyma 1*; Edcor 2,4,6; Electro-Voice 1,2,5-7*; GC Electronics 1,2,6,7; Alan Gordon 4,7*; Gotham Audio 2,5-7*; Harris 1,2,6,7*; Karl Heitz 7*; HM Electronics 4*; Image Devices 2,6*; Landy 2,4; LTM 7*; Marti 1*; Microtran 7*; Nady 4*; Nagra 6*; Nakamichi 1,2,5*; Panasonic 1,2*; Paso Sound 1,4,6,7*; R-Columbia 1,2*; Redding 7*; RMS 1*; Sansui 1,2,7*; Sawyer Camera 4; Ken Schaffer 4*; Sennheiser 1,2,4-7*; Shure 1-3,6,7*; Sony Video 4*; Studer Revox 1,2*; Superscope 2; Swintek 4*; Teac 1,2*; Television Equipment 1*; Telex 1,6*; Vidair 1,2*; VIF Intl 1*

When Your Wand Is Wanting Abracadabra..... Oki!



NTSC



PAL



SECAM

The LT1200 Digital Television Standards Converter is Oki's highly portable answer to the problem of different television standards—NTSC, SECAM, PAL, and PAL M. Whether you need tape-to-tape conversion in the studio or real-time conversion in a broadcasting station, the LT1200 can handle it. Superb image quality backs up a host of valuable features. Like frame synchronization, time based correction (TBC), one-touch freeze switch, and totally-automatic operation. When you're ready to go international, leave the magic to Oki.



Oki Portable Digital TV Standards Converter **LT1200**

Head Office: (International Division)
10-3, Shibaura 4-chome,
Minato-ku, Tokyo 108, Japan
Tel: (03) 454-2111
Telex: J22627
Cable: OKIDENKI TOKYO

OKI Electric Overseas Corp.:
Two University Plaza,
Hackensack, New Jersey
07601 U.S.A.
Tel: 201-646-0011—0015
TWX: 7109905004 OKI ELEC HAK

OKI Electric Europe GmbH:
Emanuel-Leutze str. 8, 4000,
Düsseldorf 11, West Germany
Tel: (0211) 592031
TLX: 8587218 OKID

OKI
electric
industry
company, Ltd.

Circle 137 on Reader Service Card

Source Locator: AUDIO cont.

Music Synthesizers	ARP Instruments*; Electronic Music Labs*; Ionic Ind; Moog Music; Yamaha*
Noise Reduction Systems	ADM*; Audio & Design*; dbx*; Dolby*; Eventide*; Frequency Devices; Gotham Audio*; Harris*; Inovonics*; Landy; MCI/Quantel*; Micro Communications*; Nakamichi*; Orange County*; Teac*; Thomson-CSF*
Patch Panels	ADM*; Atlas*; Audio Accessories; Audio Technologies*; Broadcast Electronics*; Dyma*; Dielectric*; Harris*; Image Video*; Inovonics*; Kings; Landy; McCurdy*; Potomac Instruments*; QRK*; Shively*; Switchcraft*; Tangent*; Trompeter*; Wide Band
Speakers	Acoustic Research*; Advent; Altec*; Atlas Sound*; Audicon*; Audio-Technica*; Audiotechniques; Auernheimer*; Auratone*; BGW Systems*; Broadcast Electronics*; Cetec*; Electro-Voice*; GC Electronics; Gotham Audio*; Hammond; Harris*; Heath; Integrated Sound*; Koss; Landy; James B. Lansing*; Micro-Acoustics*; Panasonic*; Paso Sound*; QRK*; Ramko*; Rohde & Schwarz*; Sansui*; Sharp*; Shure*; Spectra Sonics*; Superscope; Tandberg; Tapco; Technics*; Telectro*; UREI*; US Pioneer; VIF Intl*; Vision Sound*; Westlake Audio; Yamaha*
Synchronizing Equipment 1. SMPTE time code system 2. other	Ampex 1*; Ampro-Scully 2*; BTX 1*; Convergence 1*; Datametrics 1*; Datatron 1*; EECO 1*; Electro & Optical 1; Gray 1*; Harris 1*; Landy 1; MCI 1*; Philips 1*; Quintek 1*; Sharepoint 2*; Skotel 1*; Studer Revox 1*; Tangent 1*; True Time 1*
Tape, Magnetic 1. open-reel tape 2. cartridges 3. cassettes 4. test tapes	Agfa-Gevaert1*; Ampex Magnetic Tape 1-3*; Aristocart 2,4*; Audio-Technica 2*; BASF 1-4; Broadcast Cartridge 2*; Broadcast Electronics 1,2,4*; Capitol Magnetics 2,3*; Comprehensive Video 1,3*; DAK 1,2; Eumig 3*; Fidelipac 2,4*; Fuji 1-3*; Gruver 1,3; Harris 1,3,4*; Intl Audio 3; Landy 1-4; 3M/Magnetic A/V 1-3; Magnetic Reference 4*; Maxell 3; Memorex 2,3*; Nakamichi 3,4*; Network Recording Prods 1-4*; Rupert Neve 1*; Nortronics 4*; Pentagon 3; Procar 2*; RKO Tape 1,3; Sound Dynamics 1,4*; Standard Tape 4; Studer Revox 1*; Standard Tape 4*; Superscope 3; Tapecaster 2; Tapex 3,4; TDK 1-4*; Telectro 1-3*; UMC 2*; US JVC 3*; Western Broadcasting 2,4
Tape Accessories and Services 1. empty reels, carts, cassettes 2. leader tape 3. tape timers 4. tape cleaners 5. tape cleaning and evaluating services 6. rewinders 7. tension gauges 8. alignment gauges 9. other	Allsop 9*; Ampex 1*; Ampex Magnetic Tape 1*; R.B. Annis 5,9*; Aristocart*; Audico 6,9*; Audio Kinetics 9*; Audio-Technica 9*; Bretford 9; Broadcast Cartridge 1,9; Broadcast Electronics 1-4,6,8*; Cavox-Tapeathon 9*; Comprehensive Video 3,4*; DAK 1,2; Electro Sound 9; Fidelipac 1,4,8,9*; GC Electronics 1,4; Gotham Audio 3*; Gruver 1,6; Harris 1,2,8*; Inovonics 9*; Intl Nuclear 9; Landy 1,2,4; Magnesonics 6,9*; Marathon Prods 1,4,7,9; Memorex 4*; Miller-Stephenson 4; Nagra 1,3; Nakamichi 8*; Network Recording Prods 1,2,9*; Neumade 4; Nortronics 9*; Pentagon 1; Polyline 1*; Recording Supply 1,2; Recortec 4,5*; Ruslang 9*; Sharepoint 3*; Studer Revox 1*; Tapecaster 3; Tapex 1,2,7; Television Equipment 4-6*; Telex 1*; Tentel 7*; Texwipe 4,5,9*; UMC 7*; Western Broadcasting 8; Westlake Audio 4*
Cartridge Tape Player/Recorders 1. single 2. dual or triple 3. multiple (more than 3) 4. time delay	Amilon 1*; Ampro/Scully 1-3*; Audi-Cord 1,2,4*; Bell Audio 1*; Broadcast Electronics 1-4*; Cetec Broadcast 3*; Consolidated Electronics 3; Contel 1; D-B Electronics 1,2*; Harris 1,2*; IGM 1,3*; Intl Tapetronics 1-4*; Mackenzie Labs 1-3; Nakamichi 1*; Pacific Recorders 1*; Ramko 1,2*; Sono-Mag 1-4*; Telectro 1,2*; Telex 1*; UMC*

◆ MEANS VERIFIED SOURCE

Cassette Tape Player/Recorders	Amilon*; Audiotechnics*; Bell & Howell; Edco; Lexicon; Nakamichi*; Neal Ferrograph*; Panasonic*; Ramko*; H.H. Scott; Sharpe; Superscope; Tandberg; Teac*; Technics*; Telex*; Variable Speech; Yamaha*
---------------------------------------	---

Low Frequency Extenders	Comrex*; dbx*; McCurdy*; Multidyne*
--------------------------------	-------------------------------------

Open-Reel Tape Player/Recorders 1. portable 2. studio systems 3. time delay 4. logging recorders	Accurate Sound 1,2*; Ampex 1-3*; Ampro/Scully 2*; Broadcast Electronics 1-3*; Cavox-Tapeathon 1,2*; Consolidated Electronics 2; Dyma 3*; Electro Sound 1,2; Intl Tapetronics 1*; Landy 1,2; Lexicon 3; LTM 1*; 3M 2,4*; Magna-Tech 2*; MCI 2*; Nagra 1*; Neal Ferrograph 1,2,4*; Otari 1,2*; Panasonic 2*; Ramko 2*; RCA Broadcast 2*; Sony Video 1,2*; Sound Dynamics 2; Soundscriber 4*; Stancil-Hoffman 4; Studer Revox 1-4*; Tandberg 1,2; Teac 2*; Technics 2*; Telectro 4*; Telex 1,2,4*; United Research 2*; US Pioneer 2; VIF Intl 2*
---	---

Tape Heads 1. replacement 2. rebuilt	Accurate Sound 1,2*; Broadcast Electronics 1*; Brush Magnetic 1; Computer Magnetics 2; Forgflo 1; Grandy 1,2; Intl Electro-Magnetics 1,2*; Magna-Tech 1*; Michigan Magnetics 1; Minneapolis Magnetics 1*; Nortronics 1*; Saki 1,2; Sound Dynamics 2*; Soundscriber 1*; Studer Revox 1*; Taber 1,2*; Tapex 1; Vikron 1
---	---

Tape Duplicators	Accurate Sound*; Audio/Tek; Cetec Gausse*; Electro Sound; Garner; Gruver; Intl Audio; Magnefax*; Merlin*; Otari*; Pentagon; RKO Tape*; LJ Scully; Telectro*; Telex*
-------------------------	---

Tape Editing Equipment and Accessories 1. splicing blocks & tape 2. electronic editors 3. digital audio editors	Broadcast Electronics 1*; BTX 1,2*; Comprehensive Video 1*; Convergence 2*; Datatron 2*; EECO 2*; Eigen 1*; Electro Sound 1; EMS 2*; Fidelipac 1*; GC Electronics 1; Gotham 1*; Harris 1*; Lauderdale 1*; Marathon 1; Neumade 1; Nortronics 1*; Redding 1*; Sharepoint 1-3*; Studer Revox 2*; Westlake 1*
---	---

Tape and Head Erasers 1. head degaussers 2. bulk erasers 3. conveyer erasers	R.B. Annis*; Broadcast Electronics 1-3*; Cetec Broadcast 2*; Comprehensive Video 1,2*; Fidelipac 2*; Garner 3; GC Electronics 1,2; Harris 1,2*; Landy 1; Lauderdale 2*; Magnefax 2*; Marathon 1; McMartin 2*; Microtran 1,2*; Nakamichi 1*; Nortronics 2*; Optek 2; Taber 2*; Tapex 1,2; Teac 1*; UMC 1,2*; VIF Intl 2*; Wide Range Electronics 1,2
--	---

Tape Storage 1. open-reel 2. cartridge 3. cassette	Aristocart 3*; Bretford 1-3; Broadcast Cartridge 2*; Broadcast Electronics 2*; Comprehensive Video 3*; Dyma 1-3*; Fidelipac 2*; Grinnan 1,2; Harris 2*; Lauderdale 2*; Micro-Trak 2*; Neumade 1-3; Simpax 2; Storeel 1-3; Studer Revox 1*; Tapex 1-3; Wallach & Assoc 1-3*; Western Broadcasting 2; Winsted 1-3*
--	--

Telephone Coupling Equipment	Ampro/Scully*; Audio Accessories*; Broadcast Electronics*; Channelmatic; Comrex*; ITI; Kahn; Mangasync/Moviola*; Nationwide*; Norcom; Redding Radio*; RTS Systems*; Shure*; Studer Revox*
-------------------------------------	---

Audio Level Indicators 1. VU 2. PPM 3. LED or other	Applied Technology 1,2*; Audio & Design 1-3*; Audio Processing 3*; Audio Technologies 1,3*; Audio Technology 2; Boston Sound & Power 3; Crompton 1,2; Electro & Optical 2; ESE 3*; GC Electronics 1; Gotham Audio 1-3*; Harrison 3*; Heath 3*; Intl Instruments 1,2; Listec 2*; Logitek 1-3*; McCurdy 2*; Micmix 1-3; Nationwide 1*; Quad Eight 1,3*; Ramko 3*; Sansui 1*; Scott Instruments 1,2; Sharepoint 2*; Spectra Sonics 1*; Tangent 1-3*; Teac 1*; Technics 2*; Tektronix 2,3*; TM 1; Triplett 1; 2005 AD 1,2; UREI 1*; Weston 1,2
---	--

II. VIDEO EQUIPMENT

Audio/Video Recorder Synchronizers 1. SMPTE 2. other	Ampex 1*; BTX 1*; Cezar 2*; Control Video 1*; Dyma 1,2*; EECO 1*; Electro & Optical 1; Johnson Electronics 1,2; MCI 1*; Philips*; Orgon Magnetics 2; Skotel 1*; Studer Revox*
---	---

YOU SHOULDN'T HAVE TO WAIT SIX MONTHS TO GO ONE INCH.



After spending six months researching the purchase of a 1" VTR, you shouldn't have to wait another six to get it.

Introducing the 3M TT-7000 "C" 1" VTR. The technology of today that's available today.

The TT-7000 is sold and serviced by 3M. One of the largest suppliers to the broadcast industry. And it's built by one of the most respected manufacturers of video equipment: Nippon Electric Company.

Which means you get all the standard features

found in other 1" VTRs. Plus a few important extras. Like full audio/video confidence heads, built-in FM calibrate oscillator/marker, and a sync channel.

For complete details and technical specs on the TT-7000, call (612) 733-7914. Or write: 3M/Mincom Division—Video Products, 3M Center/223-5E, St. Paul, MN. 55101.

If you don't take too much time making your decision, you can get the TT-7000 in practically no time at all.

Circle 133 on Reader Service Card

3M

Source Locator: VIDEO cont.

Automated Cartridge/Cassette Players

1. quad
2. one-inch

Ampex 1•; Central Dynamics 2•; Echo 2•; Fernseh 2•; GVG 2•; Magna-Tech 2•; RCA Broadcast 1•

Cameras, TV, Color Studio

1. over \$50,000
2. \$25 - 50,000
3. below \$25,000

Ampex 1•; Cinema Products 2•; Commercial Electronics 2•; Fernseh 1•; GBC 3; Harris 1,2•; Hitachi 2,3•; Ikegami 1-3•; Intl Video 1,2; Marconi 1,2•; Nytone 3•; Panasonic 2,3•; Philips Broadcast 1-3•; RCA 1,2•; Sharp 3•; Thomson-CSF 1-3•; Toshiba 1-3•; US JVC 3•

Cameras, TV Mono

Dage-MTI•; Fernseh•; Ikegami•; Image Resource•; Javelin•; Panasonic•; Sharp•; Sony Video•; US JVC•; Video Optics; Westinghouse

Cameras, TV, Portable ENG/EFP/EC

1. over \$20,000
2. \$12 - \$20,000
3. less than \$12,000

Akai America 3; Ampex 1•; Asaca 1-3•; Cinema Products 1•; Commercial Electronics 1,2,3•; ENG Helicopter Satellites 1; Fernseh 1•; Hitachi 1,2•; Ikegami 1-3•; Image Resource 3•; Intl Video 1; Landy 1; Magna-Tech 1•; Marconi 1-3•; NEC 1•; Panasonic 1-3•; Philips Broadcast 1•; RCA 1•; Sharp 1-3•; Sony 1-3•; Thomson-CSF 1-3•; Toshiba 1,2•; US JVC 3•

Camera Heads, Mounts, Dollies, etc.

1. heads
2. tripods
3. pedestals
4. stabilizing systems
5. ENG camera braces
6. cranes
7. dollies
8. other

Arriflex 2•; Bardwell & McAlister 2•; Birns & Sawyer 1,2,7; Cine 60 5•; Cinema Products 1,2,4•; Comprehensive Video 1,2,5,7•; Dornell 6; ENG Helicopter Satellites 4,5; ENG Mfg 6•; GBC 8; Alan Gordon 1,2; Gruber 8; Harris 1-3•; Karl Heitz 1,2,7•; Image Devices 5•; Innovative 1-3,7,8•; Kandtt 5,7; K&H 5,7,8; Landy 1-3,5,7; Lee-Ray 7; Listec 1-7•; Magnasync/Moviola 1•; Magna-Tech 2; Matthews 7,8•; O'Connor 1,2; Panasonic 2•; Power-Optics 4; Quick-Set 1-3,7•; Stena 4•; Smith-Victor 2,7•; Tele-Cine 4•; Television Products 3•; Van Ladder 8; Wilcox-Lange 1•

Camera Optics

1. lenses
2. filters
3. lens adapters
4. extenders

AIC 1; Angenieux 1,3,4•; AVA 2-4•; Canon 1•; Cinema Products 1•; Commercial Electronics 2-4•; Comprehensive Video 1•; D.O. Industries 1•; F&B/Ceco 1•; Fujinon 1•; Harris 1,3,4•; Karl Heitz 3•; Javelin 1,4•; Landy 1,3,4; Lenzar 1•; Listec 1,3,4•; Panasonic 1•; Schneider 1-4•; Warren R. Smith 3•; Tele-Cine 1•; Tiffen 2,3•; Wide Range 3; Visual Methods 1-4•; Zoomar 1

Camera Power Packs (batteries)

Anton/Bauer•; Christie; Cinema Products•; Cine 60•; Comprehensive Video•; Frezzolini•; Landy; Harris•; Media Concepts•; Panasonic•; Yardney•

Chroma Keyers

1. RGB
2. encoded
3. luminance

American Data 1•; Broadcast Video 1-3•; Central Dynamics 1-3•; Crosspoint Latch 2•; Dynasciences 2•; Dytek 1-3; Grass Valley 1,2•; Image Video 1-3•; Intl Nuclear 1; ISI 1,2•; J&D Electronics 1; Landy 1-3; 3M/Mincom 1•; Panasonic 1•; RCA 1•; Shintron 2,3•; Telmet 1,2•; Thomson-CSF 1•; Vamco 1-3; Vital 1,2•

Color Correctors

Ampex•; Broadcast Video•; Fernseh•; For-A•; Harris•; Ikegami•; Landy; Microtime; RCA•; Siegel•; Thomson-CSF•

Color Encoders

Broadcast Video•; Cohu•; Crosspoint Latch; Fernseh•; Ikegami•; Landy; Lenco; MPB•; RCA•

Digital Video Noise Reducer (standalone)

Digital Video•; Fernseh•; Harris Video•; MCI/Quantel•; Microtime•; NEC•; Philips Broadcast•; Thomson-CSF•

Dropout Compensators

Digital Video•; Edutron•; Microtime•; NEC•; RCA•; Studio Film & Tape•

◆ MEANS VERIFIED SOURCE

Electronic Character/Graphics Systems

1. titlers (only)
2. full graphics systems

Ampex 2•; Ann Arbor 1•; Barda 1•; Beston 1•; Boston Elec 1; BJA Systems 2•; Chyron 2•; Dynasciences 2•; Electro & Optical 1; Fernseh 2•; For-A 1,2•; Image Resource 2•; Interand 2•; Kaitronics 1•; Kallman 1; Knox 2•; Laird 2•; 3M/Data Products 1,2•; 3M Video 1,2•; MPB 2•; MSI 1; Multidyne 1•; Newscan 2•; Panasonic 1,2•; QSI 1; Reynolds/Leteron 1,2; Shintron 1•; System Concepts 1•; Thalner 1; Thomson-CSF 2•; Video Data 1•; Visual Methods 1•; Weathermation 2•

Electronic Still Stores

ADDA•; Ampex•; Arvin/Echo•; Eigen•; Harris Video•; MCI/Quantel•; NEC•; Oktel; US JVC•

Film Telecine Equipment

1. 16 mm projectors
2. slide projectors
3. multiplexers
4. complete systems
5. film cart players

Bell & Howell 1,2,4; Buhl 2,3•; CMX•; Cohu 3,4•; Fernseh 3,4•; GBC 4; Laird 3; Landy 4; L-W Intl 1•; Magnasync/Moviola 4•; Multi-Track 1•; W.A. Palmer 1•; Philips Broadcast 4•; Radmar 1,3•; RCA 1,4,5•; Spindler & Sauppe 2•; Strand Century 4•; Teledyne 4; Tele-Measurements 2; Thomson-CSF 3•; Zei-Mark 2-4

Image Enhancers

Asaca•; Colorado Video•; Dynasciences•; Edutron•; Faroudja•; Fernseh•; Harris•; Ikegami•; Kalart Victor•; Landy; 3M/Data Products•; 3M/Video•; MCI/Quantel•; Microtime•; Siegel•; Thomson-CSF•; Vidicraft•

Master Control Switchers

1. manual
2. automated
3. business auto interface

American Data 1,2•; Ampex 1,2•; Beaveronics 1•; Central Dynamics 1-3•; Comad 1,2; Grass Valley 1,2•; Image Video 1-3•; Intl Nuclear 1; ISI 1,2•; Ross 1; Torpey Controls 2; Video Specialties 2; Viscount 1•; Vital 1-3•

Monitor Calibrators

Kallman; Power-Optics; Tektronix•; Television Equipment•; Visual Information

Monitors, Picture

1. monochrome
2. color
3. dc portable

Amtron 2,3•; Asaca 1-3•; Audiotronics 1•; Broadcast Video 2•; Cohu 1•; Conrac 1,3•; Dage-MTI 1•; Electrohome 1,2•; Faroudja 2•; Fernseh 1,2•; Hitachi 1,2•; Ikegami 1-3•; Image Devices 2•; Javelin 1,2•; Landy 1-3; Lectrotech 2•; Lenco 1•; Motorola 1•; Panasonic 1,2,3•; Rohde & Schwarz 1,2•; Sharp 2•; Sony 1,2•; Tektronix 2•; Unimedia 2; US/JVC 1-3•; Video Aids 2•; Videotek 2,3•; World Video 2,3•

Processing Amplifiers

Audin & Design•; Automation Techniques•; AVI Broadcast Video•; Central Dynamics•; CML•; Dynasciences•; Fernseh•; Grass Valley•; Harris•; ISI•; Landy; Leitch•; Lenco•; 3M/Video•; NEC•; Richmond Hill; Siegel•; Sigma; Tektronix•; Versa Count•; Vital•

Production Switchers

1. large (studio)
2. small (studio)
3. portable
4. automated (memory-assisted)

American Data 1,2,4•; Ampex 1,2,4•; Asaca 2; Avonix 2; Beaveronics 1-3•; Broadcast Video 2,3•; Camera Mart 2•; Central Dynamics 1-4•; Centro 2•; Crosspoint Latch 1-3•; Dage-MTI 2•; Datatron 2•; Echolab 2,3•; Grass Valley 1,2,4•; Ikegami 2,3•; Image Video 2•; Intl Nuclear 1,2; ISI 1,2,4•; J&D Electronics 1-3; 3M Data Products 2•; 3M Video 2,3•; Marconi 1-3•; NEC 1•; Philips Broadcast 2•; QSI 2•; Richmond Hill 2; Shintron 2•; Sony 2•; Telemet 2•; Toshiba 3•; US JVC 3•; Viscount 2,3•; Vital 1-4•

Pulse and Distribution Amplifiers

1. pulse
2. distribution
3. subcarrier
4. other

American Data 1-4•; Applied Video 1-3; Audio & Design 2•; AVA 2•; AVL 2,4•; Broadcast Electronics 2•; Broadcast Video 1-3•; Central Dynamics 1,2•; Channelmatic 2; Cohu 1,2•; Comprehensive Video 2•; Dage-MTI 2•; Datatek 1-4•; Di-Tech 1,2; Dynair 1-3•; Dynasciences 1•; Fernseh 1-3•; GBC 1,2; Grass Valley 1-4•; Harris 1•; Hedco 1-3•; Image Video 2•; Intl Nuclear 1-3; ISI 2,3•; Javelin 2•; J&D Electronics 1,2; Kay Elemetrics 2; Landy 1,2; Leitch 1-4•; Lenco 1,2•; 3M Data Products 1-3•; 3M/Video 1-3•; Marconi 1-3•; Multidyne 2-4•; NEC 1,2•; North Hills 1,2•; QSI 2•; Richmond Hill 1,2; RMS 2•; Shintron 1,3; Sigma 1-3; Telemet 1,2•; Vamco 2; Varian Electron 1•; Video Aids 2•; Vidicraft 2•; Viscount 2•; Vital 1-3•

III. FILM EQUIPMENT

Cameras, Cine	AIC; Arriflex*; Bach Auricon; Bell & Howell; Canon Scoopic*; Cinema Products*; Eastman Kodak*; Eumig; Frezzolini*; General Camera; Heitz*; L-W*; Palmer*; Sawyer; Schneider*
Camera Lenses	AIC; Angenieux*; Arriflex*; Bell & Howell; Canon*; Canon Scoopic*; Century Precision; Cinema Products*; F&B/Ceco*; Fujinon*; Heitz*; Javelin*; Lenzar*; Sawyer; Schneider*; Tele-Cine*
Camera Tripods and Accessories	Arriflex*; Bardwell & McAlister*; Bach Auricon; Bell & Howell; Birns & Sawyer; Canon*; CEI*; Cinema Products*; Comprehensive Video*; F&B/Ceco*; Frezzolini*; Alan Gordon; Heitz*; Image Devices; ITE*; Matthews*; O'Connor; Sawyer; Smith-Victor*; Tiffen*
Film	Agfa-Gevaert*; Eastman Kodak*; Studio Film & Tape*
Film Cases	Excalibur*; Neumade; Paulmar*; Plastic Reel*; Thermodyne*
Film Cleaners	Kinetronics*; Lipsner-Smith*; Neumade; Paulmar*; Plastic Reel*; RTI
Film Editing Equipment	Birns & Sawyer 1-3; Cinema Products 1*; Kalart Victor 1,3*; KB Systems 2*; Magnasync/Moviola 1-3*; Paulmar 2,3*; Plastic Reel 3*; Research Technology 1-3*
Film, Misc.	CPAC 1; Houston Fearless 1; Kreonite 3; Magnasync/Moviola 4*; Magna-Tech 3*; Neumade 4; W.A. Palmer 5*; Pako 2; Paulmar 4,5*; Studer Revox 3*; Variable Speech 5; Wallach & Assoc 5*; Winsted 5*
Film Processors	AIC; Eastman Kodak*; Filmline; Houston Fearless; Houston Photo; Jamison; Pako; Paulmar*; Radmar*; Treise
Film Projectors	Bell & Howell 1,2; Alan Gordon 1*; Karl Heitz 1*; Kalart Victor 1*; Laird 2*; L-W Intl 1,3*; Mackenzie 1,2; Magna-Tech 1,3*; W.A. Palmer 1*; Rangertone 1,2; Sawyer Camera 1,2,3; Singer 1,2; Spindler & Sappe 2*; Zei-Mark 2
Magnetic Film	Agfa-Gevaert 1,2*; Kalart Victor 1*; 3M/Magnetic A/V Products 1*; Plastic Reel 1,2*; Standard Tape 2*; Studio Film & Tape 1*
Magnetic Recording Equipment and Accessories	R.B. Annis*; Forgflo; Frezzolini*; General Camera; Image Devices*; KB Systems*; Magnasync/Moviola*; Magna-Tech*; MCI*; Multi-Track*; Orange County*; Rangertone; RCA; Standard Tape
Optical Printers	Image Resource*; Teledyne Camera Systems*; Wide Range

IV. LIGHTING

Lamps	Barbizon*; Bardwell & McAlister*; Belden*; Berkey Colortran*; Comprehensive Video*; GE Lighting*; Great American Market*; GTE*; Harwood; Janson*; Lowel-Light*; Packaged Lightings*; Panoak*; Smith-Victor*; Strand Century*
--------------	--

Lighting Control Systems

1. manual
2. automated
3. dimmer packs

Avab America 1-3*; Belden 1-3*; Berkey Colortran 1-3*; Custom Audio 1; Electro Controls 1-3; Electronics Diversified 1-3*; Great American Market 1-3*; Hammond 1-3; Janson 3*; Kliegl 1,2*; Laird 2; Lauderdale 2*; Mackenzie 2; Mole-Richardson*; Olesen 3; Packaged Lighting 1,3*; Panoak 1-3*; Rainbo 1*; Skirpan 1-3; Smith-Victor 1-3; Strand Century 1-3*; Theatre Techniques 1,2; Ultra Audio Pixtec 1-3*

Lighting Hardware and Accessories

1. heads, stands and fixtures
2. diffusion material
3. gels and filters/special effects

Anton/Bauer 1*; Bardwell & McAlister 1*; Belden 1-3*; Berkey Colortran 1,2*; Birns & Sawyer 1; Cinema Products 1*; Cine 60 1*; Comprehensive Video 1-3*; Electronics Diversified 1*; Great American Market 1*; Harwood 1,2; Karl Heitz 1*; Janson 1,3*; Kliegl 1*; Kreonite 1; Lowel-Light 1*; LTM 1*; Matthews 1,2*; Mole-Richardson 1,3; Olesen 1,3; Packaged Lighting 1-3*; Panoak 1-3*; Constantine N. Polites 1*; Rosco 1-3; Smith-Victor 1-3*; Strand Century 1-3*

Patch Terminals

Barbizon*; Berkey Colortran*; Electro Controls; Electronics Diversified*; Janson*; Kliegl*; Panoak*; Skirpan; Strand Century*; Theatre Techniques; Union Connectors

Plugs and Connectors

Audio Accessories; Barbizon*; Bardwell & McAlister*; Berkey Colortran*; Comprehensive Video*; Electro Controls; Janson*; Kliegl*; LTM*; Panoak*; Strand Century*; Union Connectors

Scenery, Prefab

Comprehensive Video*; Olesen; Uni-Set*

Seamless Materials

Comprehensive Video*; Janson*; Panoak*; Syracuse Scenery & Stage*

Set Design

Imero Fiorentino*; Janson*; Lumitrol; Rosco; Uni-Set

V. RF/TRANSMITTING/RECEIVING EQUIPMENT

Demodulators

Acrodyne*; Belar*; California Microwave*; Catel; Coastcom*; Comark*; Dynair*; Fung; Harris*; McMartin*; Microwave Associates*; Oplek; Phasecom; Potomac*; QSI Systems*; RHG Electronics*; Rohde & Schwarz*; Tektronix*; Telemet*; Time & Frequency*; Townsend; Videotek*; Wilkinson

Diplexers

Acrodyne*; Alford; Canadian GE*; CCA*; Cetec Antennas*; Coastcom*; Comark*; CSP*; DBC; Dielectric*; Farinon*; Harris*; Micro Communications*; Mu-Del*; Phelps Dodge*; Shively*; Television Technology*; Tennaplex*; TerraCom*; Townsend*; Varian Electron*

Exciters

1. AM stereo
2. FM
3. TV

Acrodyne 3*; Bayly 3*; Belar 1*; Boonton 1*; Broadcast Electronics 2*; Cablewave 1*; CCA 2*; Cetec Broadcast 2*; Comark 3*; Continental 2*; Harris 1,2*; Kahn 1; LPB 1,2*; Marti 3*; McMartin 2*; NEC 2,3*; Philips Broadcast 3*; QEI 2*; Sintronic 1,2; Solid Electronics 2*; Telonic/Berkeley 3; Townsend 3; Varian/Beverly 3*; Varian Electron 1,2,3*; Versa Count 2*

Microwave Equipment

1. intercity
2. portable
3. ENG
4. airborne
5. supports, portable equipment

Alford 1; Coastcom 5*; Comark 3*; Compact Video 4*; ENG Helicopter Satellites 3,4,5; Farinon 1-4*; Gabriel 3*; GTE Lenkurt 1*; Hitachi 3*; Hughes Microwave 1*; ITE 5*; Intl Microwave 1-3; Marti 1,3*; McMartin 1,3*; Microwave Associates 1-5*; Moseley 1-4; NEC 2-4*; Nurad 3*; Rockwell 1,2*; RF Technology 1-4*; RHG 3,4*; Systron Donner 1,5; Tayburn 1-5*; Tennaplex 3*; Tepco 1-5; TerraCom 1-3*; Varian Electron 1,4*; Versa Count 1*



TAKE IT EASY.

Microcam® covers it close. Right where it lives. In the political arena or on the fifty yard line. In the heart of the city, or miles from nowhere. On location, or in studio A, Microcam covers it all. Microcam, developed by Thomson-CSF Laboratories. The first shoulder-mount color TV camera to offer the combined benefits of studio-quality broadcasting with lightweight portability. In fact, Microcam weighs just 12.4 pounds for a total of 22 pounds, complete with motorized lens and a 5 pound silver cell battery which operates the camera for 6 hours on a single charge. Microcam provides all the essential features for superior pictures from the field or in the studio.

- Automatic beam optimizer prevents comet-tailing
- Low power consumption of 20 watts
- High index f/1.4 prism assembly
- Three position gain switch 0, +9, +18 dB
- Automatic color balance, automatic iris, and black level
- Built-in masking, split-field color bar generator and 2-line enhancer
- Color genlock included as standard

- Superior light sensitivity to allow clear, sharp pictures with only two footcandles of available light
- Variable H & V Blanking to meet the latest production requirements
- Available with optional 4½" Viewfinder and Remote Control System for EFP or studio operation

Plus complete VTR Control, including start-stop, VTR standby and return video. And a complete set of operating indicators, including VTR status, located in the viewfinder.

The Thomson-CSF model MC-601 brings Broadcast quality and ease of operation to ENG, EFP, as well as studio applications.

Microcam. For close-up coverage. Easy.

For more information about the remarkable Microcams, call or write.

 **Thomson-CSF
Broadcast, Inc.**

37 Brownhouse Road,
Stamford, CT 06902
Tel. (203) 327-7700
TWX (710) 474-3346.

Circle 135 on Reader Service Card

www.americanradiohistory.com

Source Locator: TRANSMITTING cont.

Misc. RF Equipment	Acrodyne 4*; AEL 7,8; American Technology 7; Andrew 5,7; AVA 4,5,7*; Barker & Williamson 9; Belden 5; Bird 9*; Cablewave 3,5,7*; California Inst 8; Cambridge 5,7; Catel 1; Cetec Antennas 3,4; Coastcom 1*; Comark 4,5,7*; Communication Techniques 3; Comprehensive Video 5,7*; Continental Electronics 3*; CSI 2; CSP 3*; Dielectric 4*; Dynatech 7; Elcom Specialty 9*; GTE Lenkurt 1*; Harris 3-7*; Kings 7; LPB 2*; Magnecraft 7; Marconi 4*; McMartin 1,2*; Micro Communications 4,5,7*; Microwave Associates 1,4*; Moseley 1*; Mu-Del 4,8*; Multronics 3; NEC 4*; Oak 7; Panduit 7; Phasecom 2; Radio Systems 2*; Rivers 1; RMS 5,7*; Sharepoint 1,6*; Solid Electronics 1*; Surcom 9*; Television Technology 8*; Tennaplex 4*; Time & Frequency 1*; Trompeter 5,7*; United Systems 8; Whirlwind 5
Modulators	Acrodyne*; Catel; Coastcom*; Communication Techniques; DBC; Dynaire; Fung; Harris*; Javeline; Magnecraft; Marconi*; Microwave Associates*; Phasecom; QEI*; RHG*; Rohde & Schwarz*; Studer Revox*; Telemet*; Time & Frequency*; UHF*; Varian Electron*
Receivers, Comm and Monitor	Comrex*; DBC; Elcom; Emergency Alert*; Eumig*; Gorman Redlich*; GTE Lenkurt*; Lampkin*; McKay Dymek; McMartin*; Monroe; Motorola*; National Electrolab; RHG*; Rivers; Rockwell*; Scientific Radio; Sequerra; Sharepoint*; Tepco; US Pioneer; Varian*
Remote Control Systems	American Laser; Broadcast Electronics*; Cat Systems*; Comark*; CSP*; Delta*; Dyma*; Dynair*; Hallikainen & Friends*; Harris*; Marti*; Micro Control*; Monroe; Moseley*; Nurad*; PWH; Rivers; Sharepoint*; Soll*; Tayburne; Time & Frequency*
Remote Pickup Equipment	American Laser*; Broadcast Electronics*; Comrex*; Harris*; Intl Microwave; Marti*; McMartin*; Moseley*; Motorola*; Nationwide*; Russco*; Sharepoint*; Swintek*; Tayburne; Ultra Audio*
RF Amplifiers	Acrodyne*; AVA*; Barker & Williamson; Bayly*; Belar*; Blonder-Tongue; CSP*; DBC; Elcom; EMCEE*; Farinone*; Gardiner*; Harris*; Marconi*; McMartin*; Microwave Associates*; Microwave Power; Moseley*; Mu-Del*; National Electrolab; North Hills*; QEI*; RF Technology*; Tayburne*; Television Technology*; Time & Frequency*; Townsend; Varian Electron*; Versa Count*; Wide Band; Wilkinson
RF Attenuators	Ailtech, AVA*; Bird*; Comark*; CSP*; DBC; Electro Impulse*; Harris*; McGraw-Edison; Micro Communications*; Microwave Associates*; Mu-Del*; RHG*; Telonic/Berkeley; Texscan*; Varian Electron*
RF Converters	American Microsignal; California Instr; CSP*; DBC; Microwave Associates*; Mu-Del*; Television Technology*; Varian*
RF Filters	Bald Mountain*; Bird*; Blonder-Tongue; Catel*; Cetec Antennas*; Coastcom*; Coaxial Dynamics; Comark*; CSP*; DBC; ESC; Micro Communications*; Microwave Associates*; Mu-Del*; Multronics; Phelps Dodge; Tayburne*; Television Technology*; Telonic/Berkeley; Texscan*; TTE*; Varian Electron*; Wide Band
RF Loads	Alford; Bayly*; Bird*; Blonder-Tongue; Coaxial Dynamics; Comark*; Continental Electronics*; CSP*; Dielectric*; Elcom Specialty*; Electro Impulse*; Micro Communications*; Microwave Associates*; Soll*; Varian Electron*

RF Switchers	Bayly*; Cablewave*; Coaxial Dynamics; Comark*; CSP*; DBC; Delta*; Dielectric*; Dyma*; Gardiner*; ITT Jennings*; Kilovac*; Magnecraft; Micro Communications*; Microwave Associates*; Soll*; Tayburne*; Texscan*; Wide Band
---------------------	---

SCA Equipment	Alden 3; AmNet 1*; Belar 1,2*; Cetec Broadcast 1*; CSI 1; Emergency Alert Receiver 1*; Fixtune 3; Johnson 1,3; Marti 1,2*; McMartin 1,2*; Micro Control 1,2*; Moseley 1,2*; QEI 1*; Rivers 1-3; Rodelco 1,2; Sharepoint 1-3*; Solid 1*; Telautograph 3; Time & Frequency 1*
----------------------	---

STLs	Alford 1; Andrew 1; Avantek 1; Bayly 2*; Cablewave 1*; Comark 1,4*; Farinon 1*; Gabriel 4*; GTE Lenkurt 1,2*; Harris 1,3*; Intl Microwave 1; Le Croy 2*; Marti 1*; McMartin 1*; Micro Control 1*; Nurad 1*; prodelin 4; RF Technology 1*; RHG 1*; Telemet 3*; TerraCom 1*; Time & Frequency 1*; Times Wire & Cable 3; Valtec 3*; Varian 1*; Versa Count 1*
-------------	--

Satellite Earth Stations	Alden 2; Andrew 1,2*; Anixter-Mark 1*; Antennas for Communications 1; Avantek 2; California Microwave 1*; Coastcom 1*; Comark 1*; Compact Video Sales 3*; Comtech 1-3*; Fort Worth Tower 2; Gabriel Electronics 2*; Gardiner Communications 2*; GTE Lenkurt 1,2*; Harris 1-3*; Harris Satellite 1,2*; Microwave Associates 2*; NEC 2*; Prodelin 2; Rockwell 1,3*; Scientific-Atlanta 1,2*; TerraCom 2*; Varian Electron 1-3*
---------------------------------	--

Translators	Acrodyne*; Bayly*; Canadian GE*; Coastcom*; Comark*; DBC; EMCEE*; Harris*; Kitchen Productions; Rodelco; Television Technology*; Tepco; Thomson-CSF*; Time & Frequency*; Varian/Beverly*; Versa Count*
--------------------	--

Transmitters, AM	Bayly*; CCA*; Cetec Broadcast*; Collins*; Continental Electronics*; CSI; Harris*; LPB*; Marconi*; McMartin*; NEC*; RCA*; Sintronic*; Wilkinson
-------------------------	--

Transmitters, FM	Bayly*; Broadcast Electronics*; CCA*; Cetec Broadcast*; Continental*; CSI; Harris*; LPB*; Marconi*; McMartin*; Microwave Power; NEC*; QEI*; RCA*; Scientific Radio; Singer Prods; Solid Electronics*; Swintek*; Versa Count*; Wilkinson
-------------------------	---

Transmitters, TV	Acrodyne 1,2*; Bayly 2*; Bogner 1,2*; Canadian GE 1,2*; CCA t,2*; Comark 2*; EMCEE 1,2*; Harris 1,2*; Marconi 1,2*; Microwave Power 1; NEC 1,2*; Philips Broadcast 1,2*; RCA 1,2*; Rohde & Schwarz 1*; Scientific Radio t; Thomson-CSF t,2*; Townsend 1,2
-------------------------	---

Two-Way Radio Communications	Bayly*; Gruver; Motorola*; Phelps Dodge*; RCA; Scientific Radio; Sharepoint*; Swintek*
-------------------------------------	--

Weather Radar Systems	Arvin/CATV 1,2*; Enterprise Electronics 1,2; Gorman Redlich 1*; Information Processing 2*; Technology Service 1,2; Weathermation 1,2*
------------------------------	---

◆ MEANS VERIFIED SOURCE

VI. ANTENNAS/TOWERS/ TRANSMISSION LINES

Antennas, AM	Andrews; Bayly*; Cetec Antennas*; Hy-Gain; Multronics; RCA*; Rex Rheostat*; Scala*; Swager Towers*; Utility Tower*
---------------------	--

It's The Best Selling Professional Tape Machine In The World.

The MX-5050B



Because of quality that delivers unmatched reliability. Because Otari designed this machine to go to work — overtime. Because it offers the performance and features of machines which cost more than twice as much. Because of ingenious production technology and intelligent design decisions from the manufacturer of the most comprehensive line of professional tape machines in the world.

All this comes for less than \$2500.

The Otari 5050B can ease your production burdens while assuring your banker its return on investment. You can also avoid the hassles of a used or rebuilt machine with The New Workhorse.

It's a tough act to follow — but we're doing it. Keep in touch and check out the 5050B at your nearest dealer.

Dollars for dB's, it's the best tape recorder made.

The New Workhorse

OTARI

Otari Corporation
1559 Industrial Road
San Carlos, CA 94070
(415) 592-8311

In Canada:
BSR (Canada, LTD.)
P.O. Box 7003
Station B
Rexdale, Ontario M9V 4B3

Circle 136 on Reader Service Card



Best Picture:
**SCOTCH ONE-INCH
VIDEO TAPE**

Scotch™ is a registered trademark of 3M.

For the second year in a row, Scotch® 479 won the award for the best picture of the year in a test of one-inch video tapes.

We scored well in all of the twelve categories tested, but especially well in the categories that commonly represent picture quality: color dropouts, high frequency dropouts, chroma noise, signal-to-noise ratio and stop motion.

These were scientific, quantitative tests, conducted as you would conduct them yourself, with no room for brand bias. The meters didn't play favorites. The standards were the same for every brand tested. And we tested every brand.

These kinds of test results don't surprise us. We pioneered the invention of video tape. And we've been setting the standard for quality ever since.

Our quality has always been consistent from the first replay to the

last. In fact, our sophisticated binder and oxide coating are more advanced than the binders and oxides on some quad tapes. They had to be advanced to meet the special durability demands of one-inch video production.

So choose Scotch 479 for your one-inch video production. You'll find it looks good from repeated mastering all the way through post production. And we've seen the test results to prove it.



3M

Source Locator: ANTENNAS cont.

Antennas, Communications	Comtech•; Gabriel•; Motorola•; Phelps Dodge•; Scala•; Swager Tower•; Telex•; Tenna-plex•
Antennas, FM	Ailtech; Alford; Andrew•; Anixter-Mark; Bogner•; Cetec Antennas•; Cetec Broadcast•; Comark•; Harris•; Hy-Gain; McMartin•; Micro Communications•; Phelps Dodge•; RCA Broadcast•; RCA Dist & Special Products•; RMS•; Scala•; Shively•; Soll•; Swager Tower•; Tenna-plex•; Utility Tower•; Vidair•
Antennas, Microwave	Ailtech; Andrew•; Anixter-Mark•; Antennas for Communication; Alford; Bogner•; Cablewave•; Comark•; Comtech•; ENG Helicopter Satellites; Gabriel•; Harris•; Microwave Associates•; Nurad•; Prodelin; Scala•; Soladyne; Tayburn•; Terracom•
Antennas, TV 1. HP 2. CP	Acrodyne 1,2•; Alford 1; Andrew 1•; Blonder-Tongue 1,2; Bogner 1,2•; Canadian GE 1•; Cetec Antennas 1,2•; Cetec Broadcast 2•; Comark 1,2•; Comtech 2•; EMCEE 1•; Harris 1,2•; Micro Communications 1,2•; Prodelin 1; RCA Broadcast 1,2•; RCA Dist & Special Products 1•; RMS 1•; Scala 1•; Sitco 1,2; Soll 1,2•; Swager Tower 1•; SWR 1,2; Tenna-plex 1,2•
Antenna Tuning Units	CCA•; Cetec Antennas•; Comark•; CSP•; Multronics
DA Equipment	Cetec Antennas•; CSP•; Delta•; Gorman Redlich•; ISI•; Multronics; Sitco
Transmission Line and Connectors	Alford; Andrew•; Belden; Brand Rex; Cablewave•; Comark•; CSP•; Delta•; Gabriel•; Harris•; Micro Communications•; Microfect•; Multronics; Panduit; Phelps Dodge•; Prodelin; RCA Dist & Special Products•; RMS•; Shively•; Sitco; Soll•; SWR; Utility Tower•
Towers	Advance Inds; Allied Tower; Andrews Tower; Comark•; Comtech•; CSP•; E-Z Way•; Fort Worth Tower; GC Electronics; Grasis•; Harris•; Harris Satellite•; High-Lite; Kline; Microfect•; Fred Nudd•; Soll•; Stainless•; Swager Tower•; Tri-Ex; Unarco-Rohn•; Up-Right•; Utility Tower•; Will-Burt
Tower Hardware and Construction Equipment	Advance; Allied Tower; Andrews Tower; Comtech•; Copperweld•; CSP•; Decca Austin; Gabriel•; GC Electronics; Harris•; Hy-Gain; Kline; Kortick; Microfect•; Norton; Fred Nudd•; Panduit; Philadelphia Resins; Constantine N. Polites•; Tri-Ex; Unarco-Rohn•; Utility Tower•
Tower Lighting	Advance; Andrews; Comark•; CSP•; EG&G; Elcom Specialty•; Flash Technology•; Grasis•; Harris•; Hughey & Phillips; Hy-Gain; Lauderdale•; MXR; Constantine N. Polites•; Tri-Ex; Unarco-Rohn•; Utility Tower•

◆ MEANS VERIFIED SOURCE

VII. TEST & MEASUREMENT/ MONITORING/TIMING/ LOGGING EQUIPMENT

Antenna Monitors	CSP•; Delta•; Gorman Redlich•; Harris•; Marconi•; Moseley•; Potomac•
Automated Test & Measurement Systems	Fluke•; Harris•; Hewlett-Packard•; Marconi•; Nationwide•; Potomac•; Tektronix•; Texscan•

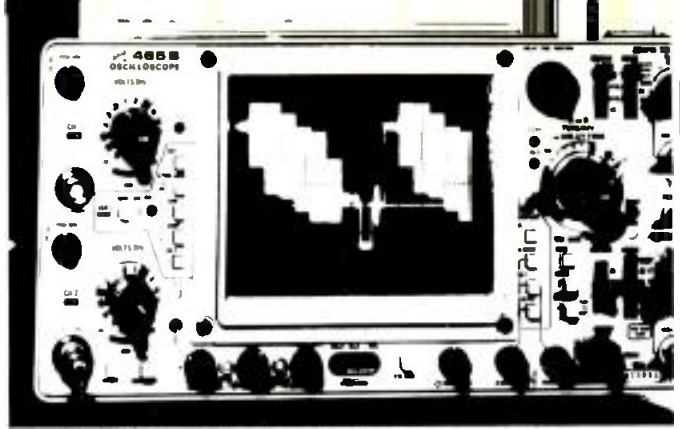

Automatic TV Monitors	Dyma•; Electra; Image Resource•; Marconi Electric•; Marconi Instruments•; Sencore; Time & Frequency•; Torpey; Video Aids•
Burst Phase Meters	Dranetz; Video Aids•
Chart Recorders	Avonix; Bruel & Kjaer•; Hewlett-Packard•; UREI•
Clocks, Time Systems 1. digital clocks 2. master clocks 3. slave clocks 4. timers 5. time distribution sys.	ABC Broadcast 1•; Applied Technology 4•; Automation Techniques 1•; Beaveronics 2,3,5•; Broadcast Aids 1,4•; Broadcast Electronics 1,2,4•; Broadcast Services 4; Bulova 2,3; Channelmatic 1,4; Chrono-Log 1-3,5•; Comprehensive Video 1,4•; Dyma 2,3,5•; EEV 1•; EEV Canada 1•; ESE 1-5•; GC Electronics 1; Harris 1,2,4•; Image Video 1,4•; Lauderdale 1,4•; Leitch 1-5•; Logitek 4•; McCurdy 1-3•; Monroe 4; Multidyne 1-5•; Nationwide 1-5•; PWH 1,2,4,5; QRK 1•; QSI 1-4•; Ramko 1,4•; Sawyer Camera 1; Sharepoint 1-5•; Sound-Scriber 1•; Standard Electric 2,4; Systron Donner 1,5; Tapecaster 2,4; Torpey 1-3,5; True Time 1-3,5•; United Systems 1,4; Vamco 1,4
Diff Phase/Gain Measurement	Asaca•; Bruel & Kjaer•; Dranetz; Hewlett-Packard•; Harris•; Lenco•; Marconi•; Phillips T&M•; Potomac•; Tektronix•; Telemet•
Field Intensity Meters 1. AM 2. FM 3. TV	Broadcast Electronics 1-3•; Harris 1-3•; McMartin 2•; Mid State 2,3•; Potomac 1-3•; PTS 3; Rohde & Schwarz 1-3•; Sadelco 3•; Sencore 1-3; Sequerra 2; Time & Frequency 1-3•
Frequency Monitors and Counters	Ailtech; Bald Mountain•; Balantine•; Belar•; James Biddle; Data Precision; Dranetz; EIP; Elcom; Fluke•; GAW; Global Specialties•; Gralex; Heath•; Hewlett-Packard•; Hickock; Ivie; Lampkin•; Leader; Lectrotech•; Marconi Instruments•; Mid State•; Motorola•; Nationwide•; Orban•; Sencore; Systron Donner; Tektronix•; Time & Frequency•; Wilkinson
Generators, Audio	Amber•; American Microsignal; Avonix; Bald Mountain•; BPI•; Bruel & Kjaer•; Dyma•; Gaw; Harris•; Hewlett-Packard•; Hickock; Ivie; Lampkin•; Leader; Marconi Electronics•; Marconi Instruments•; Monroe; Orban; Potomac•; Radiometer; Sawyer Camera; Sencore; Sescor•; Singer; Solid Electronics•; Sound Technology•; Spectra Sonics•; Tektronix•; Television Productions; Texscan•; UREI•; Wavetek Indiana; Wavetek Rockland; White
Generators, RF	Ailtech; Boonton•; Bruel & Kjaer•; Comm Techniques; Delta•; Fluke•; Global Specialties•; Harris•; Hewlett-Packard•; Hickock; Kay Elemetrics; Lampkin•; Marconi Electronics•; Marconi Instruments•; Mid State•; Motorola•; Potomac•; Radiometer; Rohde & Schwarz•; Sencore; Singer; Systron Donner; Telonic/Berkeley; Texscan•; Wavetek Indiana
Generators, Video 1. multiple output 2. cross pulse only	Automation Techniques 1•; Broadcast Video 1; Comprehensive Video 1,2•; Grass Valley 1•; Harris 1•; Hickock 1; Leader 1; Leitch 1•; Marconi Electronics 1•; Marconi Instruments 1,2•; NTI 1•; Orban 1•; Rohde & Schwarz 1,2•; United Systems 1; Video Aids 2•; Visual Information 1,2; Wavetek Indiana 1,2

Source Locator: TEST cont.

Harmonic Distortion Meters	Amber•; Asaca•; BPI•; Bruel & Kjaer•; Gaw; Heath•; Ivie; Leader; Nakamichi•; Potomac•; Radiometer; Sound Technology•
Impedance Bridges	Alford; James Biddle; Booton•; CSP•; Delta•; Hedco•; Hewlett-Packard•; Hickok; Leader; Marconi•; Potomac•; Teleonic/Berkeley; Ten-naplex•; Texscan•; Wide Band
Intermodulation Meters	Amber•; Barker & Williamson; BPI•; Bruel & Kjaer•; Crown•; Heath•; Hewlett-Packard•; Marconi Electronics•; Potomac•; Sound Technology•; TTE•
Loggers and Logger Equipment 1. tape loggers 2. log printers	Accurate Sound 1•; Amlon 1•; Cetec 2•; Fluke 1,2•; Gruver 1; Hallikainen & Friends 1•; Harris 2•; Kaitronics 1•; Nationwide 2•; Potomac•; QSI 1•; Sharepoint 1,2•; SoundScriber 1•; Stancil-Hoffman 1•; Studer Revox 1•; Telectro 1•; Telex 1•; Time & Frequency 2•
Logic Analyzers	Hewlett-Packard•; Tektronix•
Modulation Monitors	Belar•; Harris•; Hewlett-Packard•; Marconi Electronics•; Marconi Instruments•; McMartin•; Motorola•; QEI•; Sequerra; Time & Frequency•; Versa Count•
Multitest Systems	Amber•; Fluke•; Neal Ferrograph•; Potomac•; PTS; Systron Donner; Tektronix•
Oscilloscopes	Ailtech; Ballantine•; Bruel & Kjaer•; California Inst; Comprehensive Video•; Harris•; Heath•; Hewlett-Packard•; Hickok; Hitachi•; Leader; Lectrotech•; Lenco•; Motorola•; Philips T&M•; Sencore; Tektronix•; Texscan•; Ultra Audio•; Wavetek Indiana
Phase Meters	Bruel & Kjaer•; CSP•; Delta•; Dranetz; Gorman Redlich•; Harris•; Hewlett-Packard•; Leitch•; Nationwide•; Potomac•; Video Aids•; Wavetek Indiana
RF Wattmeters	Bayly•; Bird•; Boonton•; Coaxial Dynamics; Comark•; Dielectric•; Electro Controls; Electro Impulse•; Harris•; Hickok; Motorola•; Rohde & Schwarz•
Sideband Analyzers	Hewlett-Packard•; Marconi•; Rhode & Schwarz•; Tektronix•; Telemet•; UREI•; Wavetek Rockland
Spectrum Analyzers	Ailtech; Amber•; Applied Technology•; Bruel & Kjaer•; Eventide•; Harris•; Hewlett-Packard•; Inovonics•; Kay Elemetrics; Marconi Electronics•; Marconi Instruments•; Mid State•; Ken Schaffer•; H.H. Scott; Tektronix•; Telemet•; Texscan•; Wavetek Rockland; White
Status and Alarm Indicators	BI; Caringella; Coastcom•; CSI; Dyma•; Harris•; Image Video•; Moseley•; Nationwide•; Potomac•; Rivers; Sharepoint•; Time & Frequency•; Trepac; United Systems
Vectorscopes	Amtron•; Broadcast Video•; Electro & Optical; Harris•; Heath•; Lectrotech•; Rhode & Schwarz•; Sencore; Tektronix•; Ultra Audio•; Video Aids•
Video Noise Meters	Asaca; Harris•; Lenco•; Marconi Electronics•; Marconi Instruments•; Rohde & Schwarz•; Tektronix•
Video Test Generators	Colorado Video•; D&S Corley•; Leader; Leitch•; Lenco•; Marconi Electronics•; Marconi Instruments•; NTI•; Rohde & Schwarz•; Tektronix•; Telemet•

◆ MEANS VERIFIED SOURCE

VITS, VIR Systems and Equipment Marconi Electronics•; Marconi Instruments•; Rohde & Schwarz•; Tektronix•; Telemet•; Television Equipment•

Voltmeters, Multimeters, etc.
1. voltmeters
2. multimeters
3. dB meters
Amber 3•; Audio Technology 3; Bald Mountain 3•; Ballantine 1-3•; James Biddle 2•; Boonton 1,3•; BPI 1,3•; Bruel & Kjaer 1,3•; California Instruments 1,2; Crompton 1,3; Data Precision 1,2; dbx 3•; Dranetz 1,2; ESE 3•; Fluke 1,2,3•; Gaw 1; GC Electronics 1,2; Graylex 1; Harris 1•; Heath 1-3•; Hewlett-Packard 1,2,3•; Hickok 1,2; Intl Instruments 1,3; ITT Jennings 1•; Ivie 1,3; Leader 1,2; MCI 1; Motorola 1,2; Nationwide 1,2•; Potomac 1-3•; Sencore 1,2; Sharepoint 3•; Systron Donner 2; Tektronix 1,2•; Telonic Berkeley 3; TM 3; Triplett 1-3; United Systems 1; Vidare 2•; Weston 1-3

Waveform Monitors and Analyzers Amber•; Amtron•; Boonton•; Broadcast Video•; Bruel & Kjaer•; Colorado Video•; Electro & Optical; Global Specialties•; Harris•; Hitachi•; Motorola•; Tektronix•; Ultra Audio•; World Video•

Wow & Flutter Meters BPI•; Broadcast Electronics•; Bruel & Kjaer•; Fidelipac•; Leader; Marconi Electronics•; Nakamichi•; Potomac•; Radiometer

VIII. SYSTEMS & SERVICES

Computer Services/Equipment
1. business. radio
2. business. TV
3. newsroom computers
Automation Electronics 1,3•; Bonneville Broadcast 1,2; Boston Sound & Power 1•; Broadcast Management Concepts 1; Chase Media 1-3•; Columbine 1,2•; Computer Business 1-3•; Computer Concepts 1•; Computer Management 1,2•; Cox Data 2; Custom Business Systems 1•; Data Communications 1,2•; Grotton Computer 1•; IGM 1•; Image Resource 2•; Jefferson Data 1,2,3•; Kaman Sciences 1-3•; Marketron 1,2•; Matrix 1•; NEAS 2; Newscan 3•; Nidus 1,2•; Patrick Computer 1,2•; PWH 1,2•; Register Data 1•; Southwestern Programming 1•; Station Business 1-3•; System Concepts 3•; TvNS 3•

EBS Two-Tone Systems Broadcast Electronics•; Elcom; Emergency Alert•; ESE•; Fixtune; Gorman-Redlich•; Gaw; Harris•; Intl Nuclear; Landy; Logitek•; McMartin•; Rivers; Time & Frequency•

Equipment Rental Services
1. production equipment
2. post-production equipment
Accurate Sound 1•; AF Associates 1•; All Mobile Video 1,2; Avonix 1; BAA 1; Belden 1•; Broadcast Services 1; Birns & Sawyer 1,2; Camera Mart 1•; Columbia Video 1,2•; Compact Video 1•; Comquip 1,2; Dyma 1•; F&B/Ceco 1,2•; General TV 1,2•; Alan Gordon 1•; Image Devices 1; Interface Video 1,2; Leasametric 1; Lebow 1; Legal Tapes 2; Media Concepts 1,2•; Media Expressions 1•; L. Matthew Miller 1,2•; MPCS 1,2•; Power-Optics 1; Sawyer Camera 1,2; System Associates 1; Tangent 2•; Technisphere 1,2; Tele-Cine 1•; Tele-Measurements 1; Television Graphics 2; Television Productions 1; Tri-Tronics 1,2; Videomedia 1,2•; Video Prod. Services 1; Vid-tronics 2

Facility Turnkey Installation AF Associates•; Acrodyne•; Applied Video; Atlantic Research•; Audicon•; BAA; Burden; Canadian GE•; Centro•; Comark•; Compact Video•; Comtech; DBC; Delta (Long)•; Elcom; Electro-Acoustic; Electro & Optical; Gabriel•; General TV•; Global Comm. & Eng.; Grinnan; Harris•; Jenel•; Long; Multitrack Magnetics•; Northeast Bcast; Nurad•; Pacific Recorders•; Radio Systems•; RCA Broadcast•; RF Systems; Rosner•; Sharepoint•; Soll•; Station Business Systems•; Tangent•; Television Engineering•; Tri-Tronics; Valley People•; Videomedia•; Vision Sound•; Westlake Audio•; Winegard

Fuji. When your job depends on it.

Video. You use it to make a point.
And a living.

That's why you need Fuji.

Because for networks, independent producers, audiovisual experts and other professionals who depend on us, near-perfect is never good enough.

Whatever the format—2" quad, 1", 3/4" U-matic® or 1/2" VHS or Beta cassettes—Fuji gives you the performance you need to look your best.

That's how we built our reputation for richer, more lifelike color. Clearer, sharper, crisper pictures. Superior consistency and durability. Plus freedom from dropouts, to protect your machines...as well as your reputation.

So, no matter what the job, get the tape that gets the applause. By making you look as good on the hundred-thirty-first playback as you do on the first.

Fuji. The professional tape professionals depend upon.



FUJI TAPE

One brand fits all. Better.

Magnetic Tape Division, Fuji Photo Film U.S.A., Inc.
350 Fifth Avenue, New York, New York 10001 (212) 736-3335

Circle 138 on Reader Service Card

Source Locator: SYSTEMS cont.

Financial Services	Kaman Sciences*; Vision Sound*
Laboratories, Film	Bebell*; W.A. Palmer*
Mobile Van Construction	AF Associates*; Applied Video; Atlantic Research*; Caterpillar; Centro*; Compact Video*; Dyma*; Electro-Acoustic*; Electro & Optical*; E-N-G*; General TV*; Grinnan; Gruver; Harris*; High-Lite; Jenel*; Newman/Lustig; RCA Broadcast*; Rosner*; Soll*; Tangent*; Tele-Measurements; Television Engineering*; Valad; Vision Sound*; Whirlwind; Wolf Coach*
Post-Production Services	Accurate Sound 2*; Emil Ascher 2*; Avonix 1; 1. video Columbia Video 1.4*; Compact Video 1*; 2. audio F&B/Ceco 1-4*; General TV 1.2,4; Interface 3. film Video 1,3; Ionic 2; Media Concepts 1-4*; Multit- 4. equipment rental rack 3*; W.A. Palmer*; RCA Americom 1-4*; Tangent 2*; Ultra Audio 1-3*; Video Production 1; Video Tape 1*
Stage Rental	Compact Video*; General TV*; Sawyer Cam- era
Studio Design	Accurate Sound 1*; Aderhold 1; Allied Broad- cast 1; Avonix 2; BAA 1; BSC 1; Burden 1; 1. radio Centro 1,2*; Compact Video 1,2*; Delta (Long) 2. TV 1,2*; Dyma 1,2; Electro-Acoustic 1*; Electro & Optical 2; Imero Fiorentino 2*; Fisher-Burke 1; Frequency Devices 2; General TV2*; Global Comm 1,2*; Graphic Express 2*; Grinnan 1; Harris 1,2*; Image Devices 2*; Jenel 1,2*; Lebow 1,2; Long 1,2; Lumitrol 2; McCurdy 1,2*; Micro-Trak 1*; MPCs 2*; Newman/Lustig 2*; Pacific Recorders 1*; Panoak 2*; Peirce- Phelps 2; Radio Systems 1*; Rosner 1,2*; Sawyer Camera 2; Sharepoint 1*; Soll 1,2*; Strand Century 1*; Tangent 1,2*; Television Engineering 2*; Tri-Tronics 1,2; Ultra Audio 1,2*; Uni-Set 1,2; Westlake Audio 1,2*; Whirlwind 1,2
Syndicated Radio Programming Services	Bonneville Broadcast; Broadcast Programming Intl.*; Cavox-Tapeathon*; Chase Media*; Concept Productions*; DeWolfe*; Gruver; KalaMusic*; Live Sound*; Master Broadcast*; Money Machine*; Sacred Sound*; Video Tape*
Videotape/Film Recording Transfer	Bonneville*; Columbia Video*; Compact Vid- eo*; DAK; General TV*; Goldmark; Ikegami*; Image Transform*; Interface Video; Legal Tapes; MPCs*; NTI*; W.A. Palmer*; RCA Ser- vice*; Warren R. Smith*; Tri-Tronics; Vidtronics
Weather Info Service	Alden; Arvin.CATV*; Beston*; Echo*; Enter- prise; Gorman Redlich*; Info. Processing Sys- tems*; Newscan*; Technology Services; Texas Electronics; Weatherscan*; Weather Services Intl*

◆ MEANS VERIFIED SOURCE

IX. COMPONENTS/ HARDWARE

Batteries	Advance Conversion 2; Anton/Bauer 1*; Alex- ander 1,2*; Arriflex 1*; Birns & Sawyer 1,2; 1. supplies for production equipment Christie 1,2*; Cinema Products 1*; Cine 60 1*; 2. batteries for emergency power Compact Video 2*; Comprehensive Video 1*; Fisher Berkeley 2; Frezzolini 1*; Glassman High Voltage 2; Globe Union 2; Gould 1,2*; J&D Electronics 2; Kliegl 2; Landy 1; Media Con- cepts 1*; Multiplier 1,2*; North Wind 1,2*; Per- rott 1,2*; Teledyne 2; Yardney 1,2*
------------------	---

Battery Chargers	Anton/Bauer*; Christie*; Cine 60*; Com- prehensive Video*; Frezzolini*; Globe Union; Gould*; Harris*; Heath*; Kliegl; Landy; North Wind*; Perrott*; Yardney*
Cabinets, Enclosures	Amco 1*; Anvil Cases 1,2*; Bayly 1*; Brettford 1. 19-inch equipment racks 2. cabinets/furniture 3. storage shelves 2; BSC 2; Cases Inc 1-3; Centro 1-3*; Com- prehensive Video 1-3*; Emcor 1,2; Enclosure Corp 1,2*; ENG Helicopter Satellites 1,2; Grin- nan 1,2; Gruber 1-3*; Hammond 1,3; Harris 1-3*; HSC 1,2*; Kliegl 1; Kreonite 1; LPB 1*; Micro-Trak 1,2*; Neumade 1,2; Optima 2; Pacific Recorders 1*; Panoak 1,2*; QRK 1*; Research Systems 1*; Ruslang 1,2*; Sound Dynamics 2*; Stantron 2; Storeel 3*; Ther- modyne 1*; Wallach 3*; Westlake Audio 1*; Whirlwind 1; Winsted 1-3*
Camera Pickup Tubes	Amperex*; Calvert; Ceco; Comprehensive Vid- eo*; EEV*; EEV Canada*; Harris*; Hitachi*; Levit*; RCA Dist & Special Products*; RCA Electro Optics*
Connectors	ENG Helicopter Satellites 3; GC Electronics 1,3; 1. audio 2. radio 3. electrical Harrison 1*; Panel Components 3*; Vidaire 1*
Emergency & Outboard Power	Advance Conversion 2; Centro 1*; ENG Helicopter Satellites 2; North Wind 1,2* 1. generators 2. inverters
Hum Bucking Coils	ADC*; Audio-Video Engineering; Fernseh*; Intl Nuclear; North Hills*; PTS
Quartz Crystals	Comet; Edison*; Harris*; ITT Jennings*; Levit*
Rectifiers	Amperex*; Calvert; Ceco; Delta*; EEV*; EEV Canada*; Electronic Devices*; Intl Rectifier; Levit*; Thor; Topaz; Varian Electron*; Westin- ghouse; Wilkinson
RF Gaskets	Comark*; CSP*
RF Inductors	CSP*; Multronics; North Hills*; PTS
RF Tubes	Amperex*; Calvert; Ceco; Comark*; Econco*; EEV*; EEV Canada*; Eimac*; Levit*; RCA Dist & Special Products*; Thor; Varian Electron*
Shipping Cases	Anvil*; Cases*; Kandit; K&H; Multiplier*; Neumade; Thermodyne*
Solid State Components	Amperex*; Electronic Devices*; Levit*; TTE*; Varian*
Surge Protectors	Bayly*; Delta*; Dyma*; EEV*; EEV Canada*; Intl Rectifier; Levit*; Lightning Elimination*; MCG*; Multiplier*; Siemens; Superior*; Topaz; Transtector; Wilkinson
Tools	Alpha Wire*; Cooper Group; Daburn; Ideal; In- strument Labs; Paladin*; PTS; Ripley*; Trom- petere*; Vidaire*
Transformers	ADC*; Beyer Dynamic*; Comark*; Crompton; Peter W. Dahl*; Decca Austin; Delta*; Gotham Audio*; Harris*; ITI*; Jensen*; Long; Micro- tran*; North Hills*; Superior*; Topaz*; TTE*; Vidaire*
Vacuum Tubes	Amperex*; Ceco; Comet Vacuum; Econco*; EEV*; EEV Canada*; Eimac*; Freeland*; Har- ris*; Image Transform*; Intl Rectifier; ITT Jen- nings*; Levit*; RCA Dist & Special Products*; RCA Electro Optics*; Vacuum Tube Ind; Varian Electron*; Westinghouse
Wire and Cable	Alpha*; Belden*; Boston Insulated; Brand Rex; Comark*; Comprehensive Video*; Copper- weld*; Daburn*; GC Electronics; Ideal; ITT Jennings*; ITT Suprenant; Levit*; Mohawk*; Pace; Panoak*; Prodelin; Pyramid; SWR; Times; Trompetere*; Whirlwind; Wireworks*

IMAGE

At EEV...
Your Image Is
Our Business.



Leddicon® Television
Camera Tubes

® Registered Trademark of
EEV Lead Oxide Camera Tubes

IMAGE

Leddicons assure you dynamically faithful pictures over a long life, and they are rugged.

That is why Leddicons are used in virtually every country, and by the major networks and television camera manufacturers worldwide.

If you want to improve your image, call or write for all the facts about our 2/3", 1" and 30mm Leddicon tube family.

Also ask about our Vidicons... the image standard for color telecine.



EEV, INC.

7 Westchester Plaza, Elmsford, NY 10523, 914-592-6050, TWX 710-567-1215

In Canada: EEV CANADA, LTD., 67 Westmore Drive, Rexdale, Ontario M9V 3Y6, 416-745-9494, TELEX 06-965864

In Europe: English Electric Valve Co. Ltd., Chelmsford, England CM1 2QU Tel: 0245 61777, TELEX 851-99103

Members of the GEC Group of Companies

Circle 13 on Reader Service Card

Video:

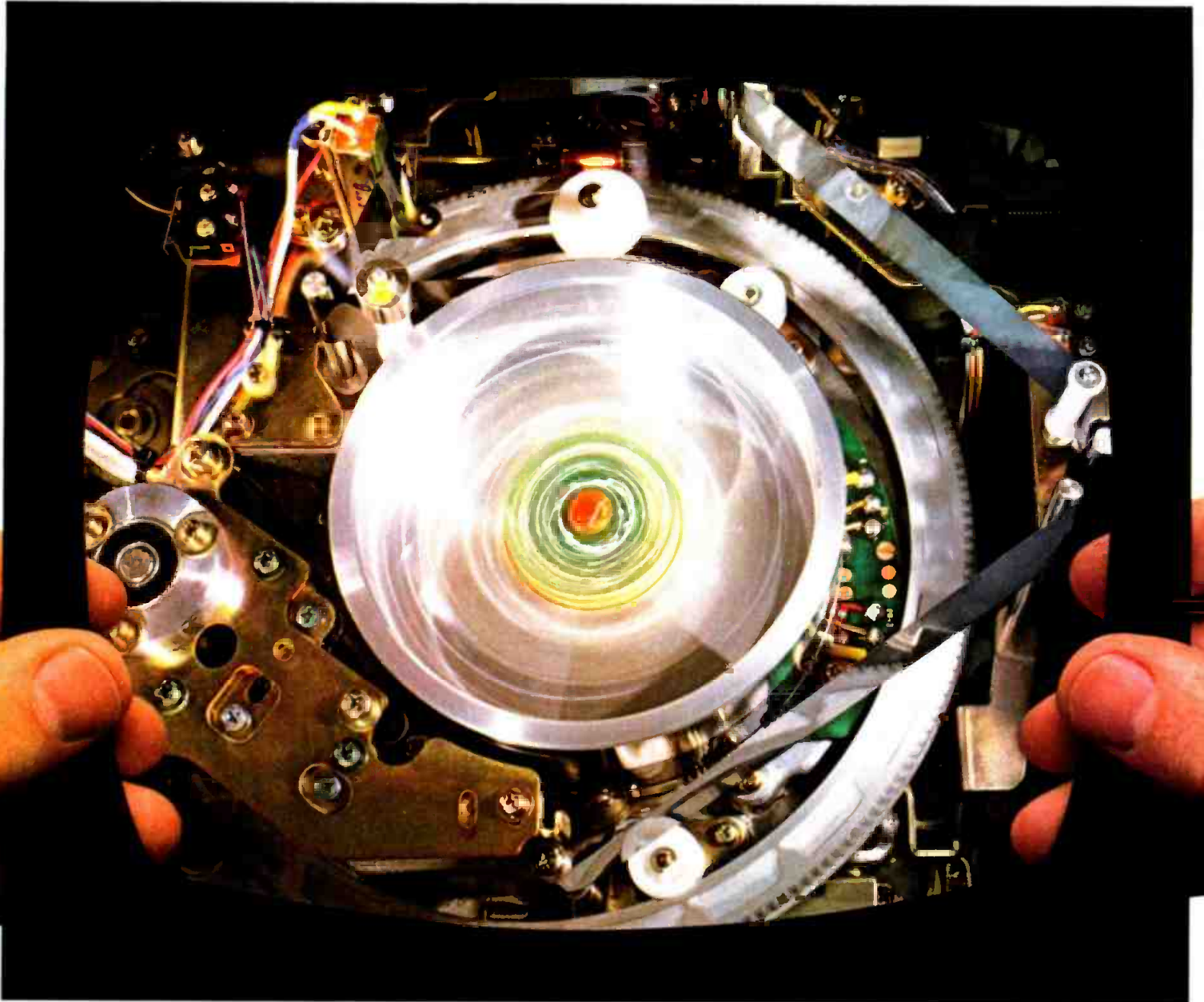

**It's time
for a new approach.
Introducing
JVC's TapeHandlers**

JVC has taken a new look at 3/4" Video Cassette Recording, with an eye for what you've been looking for.

Stability. Reliability.
Gentle tape handling.
Economy.

Take a look inside one of JVC's new TapeHandlers. You'll be amazed at what you don't see.

No pulleys.
No belts.
No idlers.

Instead, Direct Drive reel servos that keep tape tension constant for smooth and stable tape transport, reliable tape shuttling.

A simplified tape threading mechanism for gentle tape handling.

Four brushless motors that directly drive the capstan and drum servos to give stability and reliability, reduce luminance jitter to less than 5 microseconds.

A die-cast aluminum chassis to give strength, promote easy interchangeability, keep weight down.

NOT JUST NEW MECHANICAL DESIGN. NEW ELECTRONICS.

JVC's TapeHandlers not only have a new way to handle your tape, they have new electronics, too.

FM-FM direct dubbing capability for multi-generation duplication.

Microprocessor-based control logic for reliability and ease of operation.

Extremely stable horizontal phase lock.

Fully electronic tape counting and timing, with a brilliant fluorescent display.

UTMOST VERSATILITY. SIX UNITS. BROAD INTERFACING CAPABILITY.

JVC's heavy-duty TapeHandlers have been designed to have wider use than just professional video productions.

With their ruggedness, the six separate units can be used in varying combinations by anyone involved in video. And they interface without modification with most other microprocessor-based editing units on the market.

These units are just a start. Other fully compatible products, complementary in function, are soon to follow from JVC. The advances incorporated in the TapeHandlers are too important not to be extended to all who want and need to use video, at any level.

CR-8200U TapeHandler: THE NEW-GENERATION RECORDER/EDITOR.

The leader of JVC's TapeHandler Series is the all-purpose CR-8200U Recorder/Editor. A built-in rotary erase head and blanking switcher make it



RM-88U
RM-70U



CR-8200U



CR-6600U



CR-5500U

easy to perform automatic assemble (back space) editing and split insert editing—a must for professional quality video productions. The new FM-FM dubbing system transfers the chroma and luminance signals in FM form, to cut deterioration significantly. Capstan servo, of course, for top editing performance. Random access capability. Direct mode change without going through "Stop," to allow full remote control. Sub-carrier and external sync capability for use with Time Base Correctors. And, naturally, the new TapeHandler Direct Drive reel servo system to keep tape tension constant in all modes.

The CR-8200U TapeHandler is the ideal core unit around which to build a fully automatic electronic editing system

CR-6600U TapeHandler: THE FULL-FUNCTION RECORDER WITH ASSEMBLY-EDITING CAPABILITY.

The CR-6600U is the video-tape recorder designed for the busy studio. Its rugged construction and gentle tape handling give you the kind of reliability you need when workloads are heavy. The built-in automatic pre-roll mechanism and blanking switcher let you do assemble editing using only the record and pause buttons. FM-FM dubbing makes it perfect as a master VTR for multi-generation dubbing. Microprocessor-based logic allows full remote control. Two audio level control meters. External sync capability. TBC connections.

This is the recorder you'll value for its quality, reliability, versatility.

CP-5500U TapeHandler: THE COST-EFFICIENT PLAYER WITH ON-AIR QUALITY.

Want a low-cost player for stable and reliable on-air playback? That's the CP-5500U. Or use it with the CR-8200U and

an automatic editing control unit and you have a superb, fully automatic electronic editing system. Or take advantage of its FM-FM dubbing capability and use it as a companion to the CR-6600U.

It's a TapeHandler, with the stable tape transport that makes it perfect for these critical applications.

MICROPROCESSOR-BASED EDITING REMOTE CONTROL UNITS.

JVC offers you a choice of compact control units: the easy-to-operate RM-88U for precise timing of machine functions, the low-cost RM-82U, and the RM-70U full remote control unit with shuttle-search function. All are based on a full logic circuit using a microprocessor. And all have JVC's new SOFTOUCH shuttle-search control for fast and accurate location of editing points. Turning the rotary dial varies the tape playback speed continuously from still to 5 times normal, in both forward and reverse. When the desired speed is reached, just let go, and it remains locked at that speed. When you change modes, the dial automatically returns to the still position. No locking latches or pulling of knobs when you change from still to playback speed.

GET ALL THE DETAILS

Call your JVC Dealer. He'll be glad to demonstrate the TapeHandlers for you and let you try them for yourselves. Or, if you prefer to read about them first, send for our detailed catalog that spells out their specifications.

Write US JVC Corp., 58-75 Queens Midtown Expressway, Maspeth, NY 11378.

Phone toll free
800-821-7300
Ext. 7005

(In Missouri: 800-892-7655.
Ext. 7005).

Your choice.
Now. **JVC**[®]
US JVC CORP



Circle 140 on Reader Service Card

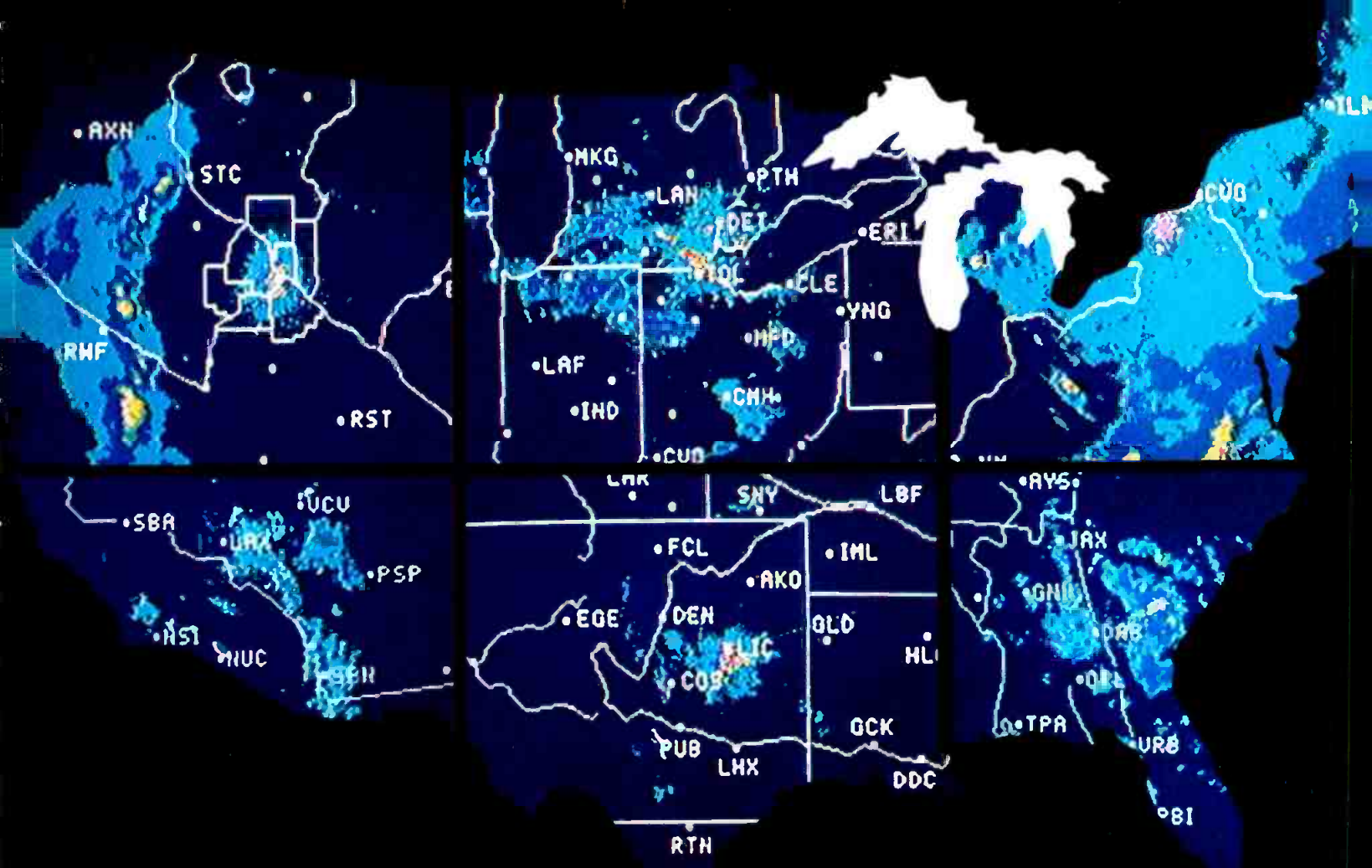

We've Got The Country Covered!

Coast to coast, north and south, WEATHERMATION's sweeping the country. With the most far-reaching dial-up radar system in the industry. With more digital transmitters at more sites than any other system. With over 100 different views of the country at your fingertips. And, as a WEATHERMATION color radar owner, each new site we add is immediately available to you, complete with map overlays. All at no extra charge.

So, no matter where you are in the continental United States, up-to-the-minute local and national weather conditions are just a phone call away. Simply pick a location, then dial it up over conventional phone lines. In just 30 seconds you'll receive a bright, clear six-color digital display.

Find out how WEATHERMATION color remote radar can work for you. Call us now or send for our free brochure. Delivery for the fall rating period is currently running only 30 days.

Circle 141 on Reader Service Card

Weathermation Inc. • 190 N. State St. • Chicago, IL 60601 (312) 263-6921

www.americanradiohistory.com

Weathermation

EQUIPMENT MANUFACTURERS

Hundreds of broadcast equipment manufacturers responded to BM/E's extensive Source questionnaire. Here they are — in alphabetical order, with addresses, telephone numbers, and product lines. The VS listing designates those companies that provided current supporting literature for their lines. Field office addresses and telephone numbers for some companies follow their product listings. Advertisers' names appear in red, with a cross reference to their ad and the rep/dist section.

A

ABC BROADCAST CONTROLS

9155 Brookville Rd Silver Spring MD 20910
301 587-3505

Full line radio automation equipment: digital clocks VS

See ad pg 148 — reps on request

ACCURATE SOUND CORP

114 5th Ave Redwood City CA 94063
415 365-2843

Mic booms & dollies; open reel player/recorders; replacement & rebuilt tape heads; tape duplicators; production equip rental; complete audio studio construction; tape loggers; post-production service VS

ACHRO-VIDEO LTD

10 Virginia Ave West Nyack NY 10994
914 358-5504

TV lens repair service

ACOUSTIC RESEARCH

10 American Dr Norwood MA 02062
617 769-4200

Speakers VS

ACRODYNE INDUSTRIES

21 Commerce Dr Montgomeryville PA 18936
215 368-2600

Demodulators; duplexers; TV exciters; RF TV combiners; modulators; TV translators; VHF & UHF TV transmitters; HP & CP TV antennas; facility turnkey installation VS

ADC PRODUCTS

4900 W 78 St Minneapolis MN 55435
612 835-6800

Audio connectors VS

ADDA CORP

1671 Dell Ave Campbell CA 95008
408 379-1500

Electronic still stores; special effects generators; frame synchronizers; helical capstan servo and non-servo TBCs; synthesizers; compressors; digital video processors VS

See ad pg 3 — refer to rep/dist section

CA	10100 Santa Monica Blvd Ste 2500	
	Los Angeles 90067	213 557-2550
GA	2693 Twigg Circle Marietta 30067	404 953-1500
VI	30310 Woodgate Dr Southfield	
	48076	313 642-4668

ADERHOLD CONSTRUCTION CO

3384 Peachtree Rd NE Atlanta GA 30326
404 233-5413

TV and radio facility construction

ADM TECHNOLOGY

16005 Sturgeon St Roseville MI 48066
313 778-8400

Audio preamps, line & dist amps; slide attenuators; audio consoles (mono, stereo, audio for TV, production); active equalizers & filters; noise reduction systems; patch panels VS

See ad pg 9

ADVANCE CONVERSION DEVICES CO

109 Eighth St Passaic NJ 07055
201 778-0707

Emergency power supplies, uninterruptible power systems, inverters; power line frequency converters

ADVANCE INDUSTRIES INC

2301 Bridgeport Dr Sioux City IA 51102
712 252-4101

Antenna towers, tower hardware and lighting

ADVENT CORP

195 Albany St Cambridge MA 02139
617 661-9500

Speakers, audio delay lines, large screen video projectors

AEL CATV COMM DIV

PO Box 552 Lansdale PA 19446
215 822-2929

Connectors, passive distribution accessories

AF ASSOCIATES INC

100 Stonehurst Court Northvale NJ 07647
201 767-1000

One-inch VTRs (Marconi), VTR rebuilding, mobile van construction, facility turnkey installations production equip rentals, color framer editing aid device, gated video circuits VS

VS MEANS IT'S VERIFIED

AGFA-GEVAERT INC

275 North St Teterboro NJ 07608
201 288-4100

Open-reel audio tape; new videotape; recording & test magnetic film; cine camera film VS

AIC PHOTO INC (ALLIED IMPEX CORP)

168 Glen Cove Road Carle Place NY 11514
516 742-7300

Lenses; film and TV (Soligor); film cameras and accessories (Bauer); film processors (JOBBO)

AILTECH (A CUTLER HAMMER CO)

19535 E Walnut Dr City of Industry CA 91748
213 965-4911

Los Angeles Operations
5340 Ailla Rd Los Angeles CA 90066
213 822-3061

RF attenuators; frequency monitors & counters; spectrum analyzers; power amps; RF generators; microwave antennas; oscilloscopes

AITKEN COMMUNICATIONS INC

214 Harrison St Taft CA 93268
805 765-5403

Monitor amps; relay & time insertion sequencers

AKAI AMERICA LTD

2139 E Del Amo Blvd Compton CA 90220
213 537-3880

Portable video cameras

AKG ACOUSTICS INC

77 Selleck St Stamford CT 06902
203 348-2121

Reverb units; stereo pickups; headphones; mics (dynamic, condenser, wireless, shotgun, lavalier); mic booms & dollies, accessories VS

AKG SALES DIV CANADA PHILIPS

105-200 Consumers Rd #105 Willowdale Ont M2J 4R4

416 494-1453

Reverb units; stereo pickups; headphones; mics (dynamic, condenser, wireless, shotgun, lavalier); mic booms and dollies, accessories VS

ALCO PRODUCTS INC

1551 Osgood St No Andover MA 01845
617 685-4371

Machined aluminum knobs

ALDEN ELECTRONIC & IMPULSE RECORDING EQUIP CO INC

1 Washington St Westboro MA 01581
617 366-8851

Fax recording systems; weather data systems, satellite earth station receivers; analog & digital facsimile weather chart scanners & recorders; remote weather radar recorders; weather satellite picture receiving systems, marine radio facsimile weather chart recorders; facsimile communications equip

ALEXANDER MFG CO

PO Box 1645 Mason City IA 50401
515 423-8955

Batteries, portable power packs, emergency power equip VS

See ad pg 112—refer to rep/dist section

FL	Alexander 409 SE 28th Ave PO Box	
	1053 Pompano Beach 33061	305 781-1181
IL	Alexander 425 S Elm St Palatine	
	60067	312 359-1153
NJ	Alexander NE 47 Lenape Dr	
	Montville 07045	201 263-1888

ALFORD MFG CO

15 Sixth Rd Woburn MA 01801
617 935-8610

Antennas, FM, TV, microwave; duplexers, RF loads; microwave units; transmission line & line accessories; impedance bridges

ALLEN AVIONICS INC

224 E 2 St PO Box 350 Mineola NY 11501
516 248-8080

Video delay lines & filters; video equalizers VS
See ad pg 145—refer to rep/dist section

ALLIED BROADCAST EQUIP

635 SE St Richmond IN 47374
317-962-8596

Audio dist amps, preamps; studio cabinets & furniture

ALLIED TOWER CO

1250 Highway 3 South Houston TX 77587
713 486-7691

Antenna towers & accessories; tower design, construction, erection

ALLISON RESEARCH INC — See Valley People Inc

Budgeting For a "Super Editor"?



Get a **VANGUARD** and Save Enough To Buy a Tempo 76 Too!

You don't have to spend a fortune to get the creative flexibility, speed and convenience that you want in a videotape editor.

Over 400 Tempo 76 and Vanguard editing systems are in service at post-production facilities all over the world. No one else in our price/performance bracket has more editing systems in operation.

The reason for our success? Simply this: Tempo and Vanguard offer higher performance and more features for the money than any other editing systems available.

Tempo provides A/B roll editing capability with up to 3 decks and a switcher. Vanguard provides A/B roll and A/B/C/D sync'd roll editing capabilities with up to 5 decks and a switcher, and also gives you selectable preroll, postroll and operator reaction times.

Both Tempo and Vanguard share an impressive list of features rarely found in their price ranges:

- **Modularity** — Your editing system can grow as you do.
- **SMPTE or Control Track Operation** — Edit with or without SMPTE code, or through time code dropouts.

- **Interfaces** — for over 40 makes and models of decks: quads, 1" types A, B & C, 3/4" VCRs, audio decks, and the Rank Cintel Mk IIIB.
 - **VaraScan™** — Variable speed tape search control allows continuously variable forward/reverse tape shuttle from high speed to freeze frame. Tempo can be equipped with one assignable VaraScan™ control; Vanguard can be equipped with dual controls. Also available on Vanguard is SmartScan™, which allows the system to memorize and perform variable speed edits, edit compression/expansion & a variety of other variable motion edit effects.
 - **Edit Lists** — Tempo can store up to 300 edit decisions; Vanguard, up to 999. Both feature powerful, uncomplicated edit list management and the full range of edit list I/O options.
 - **Auto-Assembly** — Tempo performs auto-assemblies from up to 2 source decks; Vanguard can draw upon up to 4 source decks.
- Circle 142 on Reader Service Card

- **Human Engineered Operator Consoles** — Dedicated function keyboards for fast, efficient entry of edit and split times, switcher control commands and tape deck motion control commands. Large, well organized edit parameter displays.

And to cap-off this impressive list of features, we back-up Tempo and Vanguard editing systems with a complete line of compatible SMPTE code equipment, routing switchers and editing production switchers.

Find out why creative editing doesn't have to cost a fortune. Call or write us today. Datatron, Inc./Video Systems Division, P.O. Box 11427, Santa Ana, CA 92711, Telephone (714) 544-9970.

datatron, inc.
VIDEO SYSTEMS DIVISION
We Make Creative Editing Affordable

The Source '80

ALL MOBILE VIDEO INC

630 9 Ave New York NY 10036
212 757-8919

Equip rental services including mobile units; post-production services

ALLSOP INC

4201 Meridian Bellingham WA 98225
206 734-9090

Cassette deck cleaners; VHS video cleaners VS

ALPHA WIRE CORP

711 Lidgerwood Ave Elizabeth NJ 07207
201 925-8000

Wire & cable; cable connectors VS

ALTEC LANSING

1515 S Manchester Ave Anaheim CA 92803
714 774-2900

Audio preamps, line amps; AM & FM compressor/limiters; graphic equalizers & filters; audio delay systems & special effects; audio consoles (one-output mic mixers, portable, mono & stereo multi-output studio); intercoms; mics (dynamic, condenser/electret, lavalier); mic stands, booms & dollies; audio speakers VS

AMBER ELECTRO DESIGN LTD

4810 Jean Talon West Montreal Canada H4P 2N5
514 735-4105

Audio generators; harmonic distortion meters; intermodulation meters; multitest systems; spectrum analyzers, dB meters; waveform monitors & analyzers VS

AMCO ENGINEERING CO

3801 N Rose St Schiller Pk IL 60176
312 671-6670

Cabinets, enclosures; 19-inch equipment racks VS

AMERICAN DATA CORP

401 Wynn Dr Huntsville AL 35805
205 837-5180

Audio amps (monitor & power supplies, distribution); RGB chroma keyers; manual & automated master control systems; large, small & automated production switchers; video pulse, distribution & subcarrier amps; video special effects generators; colorizers VS

See ad pg 24—refer to rep/dist section

AL B Munzer 401 Wynn Dr
Huntsville 35805 205 837-5180

CA D Cadora 3760 Cahuenga Blvd
N Hollywood 91604 213 760-3221

IN J Gardner PO Box 27324
Indianapolis 46227 317 784-3000

NJ B Blair 33 Benson Rd
Glen Rock 07452 201 447-3465

AMERICAN LASER SYSTEMS INC

106 James Fowler Rd Goleta CA 93017
805 967-0423

Infrared video transmission systems; remote control systems VS

AMERICAN MICROSIGNAL CORP

8431 Monroe Ave Stanton CA 90680
714 761-1222

Tone generators, encoders & decoders; land mobile communications systems

AMERICAN MODEM CORP

160 Wilbur Pl Bohemia NY 11716
516 567-7887

Satellite, microwave & industrial data modems

AMERICAN TECHNOLOGY CO INC

7820 Pyott Rd Crystal Lake IL 60014
815 459-7400

Coaxial connectors

AMILON CORP

49-12 30th Ave Woodside NY 11377
212 274-1794

Analog & digital audio cassette transports; endless loop tape transports; cassette data logging transport VS

AMNET

Box 3600 CFS Champaign IL 61820
217 398-2400

FM SCA equipment; market info service; complete FM SCA data broadcast service VS

AMPEREX ELECTRONIC CORP

Providence Pike Slatersville RI 02895
401 762-3800

RF tubes; vacuum tubes; camera pickup tubes; rectifiers; solid state components VS

See ad pgs 36-37

CA T Marchner 300 Scott Blvd
Santa Clara 95050 408 727-6132

CO J Burrell 3110 S Wadsworth Blvd
Ste 302 Denver 80227 303 989-7310

GA T Seaton 3300 NE Expwy Ste 1G
Atlanta 30341 404 458-2519

IL R Johnson 175 Scott St
Elk Grove Village 60007 312 640-2544

NY K Rabbitt 230 Duffy Ave
Hicksville 11802 512 931-6200

TX G Gambill 13773 N Central Expwy
Ste 1228 Dallas 75234 214 231-3481

AMPEX CORP

401 Broadway Redwood City CA 94063
415 367-2011

SMPT time code synchronizing system; audio tape, cartridges & cassettes; open reel audio tape players; recorders (portable, studio, time delay); audio/video SMPT recorder synchronizers; automated quad cassette/cart players; color studio TV cameras; color ENG/EFP cameras; color correctors; dropout compensators; video art systems; electronic still stores; large & small studio production switchers; SMPT time code readers, generators; helical capstan servo & quad TBCs; slow motion & variable speed video action recorders; new videotape & reels; two-VTR editor, controllers; multi-source editors; computerized auto assembly editors; quad & one-inch helical VTRs; new VTR heads & head refurbishing; battery chargers VS

See ad pgs 16-17

Amplex is also exclusive distributor of EECO products (see listing)

CA Tom Nielsen 500 Rodier Dr
Glendale 91201 213 240-5000

CA Russ Ide 10435 No Tantau Ave
Cupertino 95014 408 255-4800

GA Paul Hansil 3135 Chestnut
Suite 101 Atlanta 30340 404 451-7112

IL Mike D'Amore 2201 Lunt Ave
Elk Grove Village 60007 312 593-6000

MD Frank Rush 10215 Fernwood Rd
Bethesda 20034 301 530-8800

NJ Al Slater 75 Commerce Way
Hackensack 07601 201 489-7400

CAN Jean-Louis Major 132 East Dr
Bramalea Ont 416 791-3100

MEX Miguel Hernandez Apartado Postal # 13-615
Division del Norte # 1832 539-6870

AMPEX CORP MAGNETIC TAPE DIV

401 Broadway Redwood City CA 94063
415 367-4463

Open-reel magnetic audio tape & cassettes; empty reels, carts & cassettes; new videotape; videotape reels and cassettes; videotape storage VS

See ad pg 46

AMPRO/SCULLY

826 Newtown/Yardley Rd Newtown PA 18940
215 968-9000

Stereo & mono multi-output studio consoles; synchronizing equipment; single, dual & multiple cart player/recorders; open-reel studio recorders; telephone coupling equipment VS

See ad pg 51

AMTRON CORP

PO Box 1150 Aptos CA 95003
408 688-4445

Color & dc portable monitors; vectorscopes; waveform monitors & analyzers VS

ANDERS INC

77 Wolcott Rd Simsbury CT 06070
203 658-7666

Video delay lines and modules

ANDREW CORP

10500 W 153rd St Orland Park IL 60462
312 349-3300

Helix coaxial cables & connectors; UHF TV transmitting antennas; STL microwave antenna systems

VS MEANS IT'S VERIFIED

ANDREWS TOWER INC

1420 Layton Ave Ft Worth TX 76117
817 831-1222

AM antennas; antenna towers, tower accessories; tower lighting

ANGENIEUX CORP OF AMERICA

120 Derry Rd Hudson NH 03051
603 880-1710

Video camera lenses, lens adapters, extenders; film camera lenses VS

ANIXTER-MARK

2180 S Wolf Rd Des Plaines IL 60018
312 298-9420

Microwave antennas & accessories; point-to-point antennas, two-way antennas; earth station antennas

ANN ARBOR TERMINALS INC

6175 Jackson Rd Ann Arbor MI 48103
313 663-8000

CRT displays and controllers VS

R.B. ANNIS CO

1101 N Delaware St Indianapolis IN 46202
317 637-9282

Tape cleaners & equipment demagnetizers; head degaussers; magnetic recording equipment & accessories VS

ANTENNAS FOR COMMUNICATIONS INC

Silver Springs Shores Industrial Pk 486 Cypress Rd Ocala FL 32670
904 687-4121

Microwave antennas; earth station antennas

ANTON/BAUER

66 Center St Shelton CT 06484
203 735-3305

Camera power packs; lighting heads, stands & fixtures; battery supplies for production equipment; battery chargers VS

See ad pg 93—refer to rep dist section

ANVIL CASES INC

4128 Temple City Blvd Rosemead CA 91770
213 575-8614

Racks, cabinets, shipping cases & transit cases VS

See ad pg 84—refer to rep dist section

AP CIRCUIT CORP

865 West End Ave New York NY 10025
212 222-0876

Equalizers, filters (active)

APPLIED TECHNOLOGY CORP

27106 46 Ave S Kent WA 98031
206 854-4486

Audio preamps; ALC & AGC amps; AM & FM compressor/limiters; portable consoles; VU & PPM audio level indicators; spectrum analyzers; discriminate audio processors; peak limiters VS

See ad pg 200

APPLIED VIDEO ELECTRONICS INC

PO Box 25 Brunswick OH 44212
216 225-4443

Video pulse, subcarrier, & distribution amps; VTR rebuilding; mobile van construction; facility turnkey installation

ARISTOCART DIV OF WESTERN

BROADCASTING LTD
1960-505 Burrard St Vancouver BC V7X 1M6
604 687-2844

Tape cartridges, test tapes; cartridge racks VS

See ad pg 168—refer to rep dist section

ARRAKIS SYSTEMS

PO Box 296 Bolivar MO 65613
417 756-2850

Audio amps (preamps, line & distribution amps, monitor & power supplies); graphic equalizers & filters; audio consoles (one-output mic mixers, mono & stereo multi-output studio, audio for TV, automated) VS

ARP INSTRUMENTS INC

45 Hartwell Ave Lexington MA 02173
617 861-6000

Music synthesizers VS

The Source '80

ARRIFLEX CORP OF AMERICA
1 Westchester Pl Elmsford NY 10523
914 592-8510

16 mm & 35 mm cine cameras; camera lenses; tripods & accessories; batteries VS

ARTISTS' ENGINEERING
1401 43 Ave San Francisco CA 94122
415 665-4772
Videotape timers

ARVIN/CATV
4490 Old Columbus Rd NW Carroll OH 43112
614 756-9211
Radio & TV weather radar systems; weather satellite receivers VS

ARVIN/ECHO
485 E Middlefield Rd Mountain View CA 94043
415 961-7145

Electronic cassette disc; frame & field synchronizers; segmented-helical, automated, disc VTRs; VTR head refurbishing; two-VTR editor-controller (disc); video action recorders (disc; slow mo, variable speed, time lapse); electronic still stores; comb decoders; A/D converters; weather radar systems VS
See ad pg 139—refer to rep/dist section

ASACA CORP OF AMERICA
1277 Rand Rd Des Plaines Il 60016
312 298-4380

Studio/field convertible cameras; ENG/EFP cameras; picture monitors (b&w, color, dc portable); image enhancers; small production switchers; sync & color bar generator systems; quad VTRs; SEGs; harmonic distortion meters; video noise meters; diff phase-gain measurement VS
See ad pg 59—refer to rep/dist section
CA R Reilly 155-B San Lazaro Ave
Sunnyvale 94086..... 408 735-7350
NH C Miller PO Box 333 Londonderry
03053..... 603 434-0890

EMIL ASCHER MUSIC INC
630 Fifth Av New York NY 10022
212 581-4504

Recorded background and production music & sound effects library VS

ASHLY AUDIO
1099 Jay St Rochester NY 14611
716 328-9560

Audio preamps; ALC, AGC amps; AM & FM compressor/limiters/filters; automatic crossover units; active equalizers & filters

ASTATIC CORP
Box 120 Conneaut OH 44030
216 593-1111
Pickups; mics, mic stands

ATLANTIC RESEARCH CORP
5390 Cherokee Ave Alexandria VA 22314
703 642-4000

Mobile van construction, facility turnkey installation, consulting VS

ATLAS SOUND
10 Pomeroy Rd Parsippany NJ 07054
201 887-7800

Mic stands, booms & dollies; speakers VS

AUDICO INC
219 Crossen Ave Elk Grove IL 60007
312 640-1030

Semi-automatic cassette loaders; tape rewinders; videotape cleaners; audio & videotape cassette loaders VS

AUDICON MARKETING GROUP
1200 Beechwood Ave Nashville TN 37212
615 256-6900

Parametric equalizers & filters; mechanical reverb units; speakers; facility turnkey installation VS

AUDI-CORD CORP
1845 West Hovey Ave Normal IL 61761
309 452-9461

Automation sequencers; tape cartridge player/recorders (single, dual, time delay) VS

AUDIO ACCESSORIES INC
Mill St Marlow NH 03456
603 446-3335

Patch panels, plugs, jacks, audio connectors VS

AUDIO DESIGNS & MFG — See ADM Technology

AUDIO & DESIGN RECORDING INC (ADRI)
PO Box 786 Bremerton WA 98310
206 275-5009

Audio dist amps, preamps, ALC & AGC amps, parametric & graphic equalizers & filters; special effects units; AM & FM compressor/limiters; delay lines; noise reduction; VU, PPM & LED level indicators; video processing & dist amps; signal equalizing systems VS
See ad pg 130—refer to rep/dist section

AUDIO KINETICS (UK) LTD — See Quintek Inc

AUDIOMARKETING — See Audiotekniques Inc

AUDIONICS OF OREGON
Suite 160 10950 SW Fifth St Beaverton OR 97005
503 641-5225

Audio dist, power & monitor amps; preamps; op-amp modules; quad matrix equip; turntable preamps & controls

AUDIO PROCESSING SYSTEMS INC
40 Landsdowne St Cambridge MA 02139
617 354-1144

Parametric & graphic equalizers & filters; stereo multi-output audio consoles; portable & automated consoles; LED level indicators VS

AUDIOSEARS CORP
21 South St Stamford NY 12167
607 652-7305

Headphones, dynamic mics

AUDIO-TECHNICA US
1221 Commerce Dr Stow OH 44224
216 686-2600

Headphones; mics (dynamic, electret/condenser, lavalier); mic stands, booms & dollies; speakers; audio cartridges VS

AUDIOTECHNIQUES INC
652 Glenbrook Rd Stamford CT 06906
203 359-2312

Audio amps (monitor, power, public address); equalizers & filters (active & passive); mixers; mic booms & dollies; speakers; tape recorders

AUDIO TECHNOLOGIES INC
328 W Maple Ave Horsham PA 19044
215 443-0330

Audio preamps, line amps, dist amps, monitor & power supplies; graphic & parametric equalizers & filters; patchpanels; VU & LED indicators VS

AUDIO TECHNOLOGY
1169 Tower Rd Schaumburg IL 60195
312 885-0066

Audio preamps; turntable preamps and controls; PPM level indicators; dB meters

AUDIO/TEK INC
502 D Van Dell Way Campbell CA 95008
408 378-5586

Audio tape duplicators

AUDIOTRONICS
7428 Bellaire Ave North Hollywood CA 91605
213 765-2645

Headphones; dynamic, condenser, lavalier mics; monochrome picture monitors VS

AUDIOTRONICS VIDEO DISPLAY DIV
8299 Central Ave NE Spring Lake Pk MN 55432
612 780-1840

B&W video monitors; data display monitors

AUDIO-VIDEO ENGINEERING CO
65 Nancy Blvd Merrick NY 11566
516 546-4239

Hum bucking coils

AUDITRONICS INC
3750 Old Getwell Rd Memphis TN 38118
901 362-1350

Slide attenuators; mono, stereo, quad, audio for TV, & portable mixing consoles VS

See ad pg 97

AUDY INSTRUMENTS INC
35 Congress St Shetland Ind Pk Salem MA 01970
617 744-5320

Audio consoles (mono & stereo studio multi-output) VS

AUERHEIMER LABS & CO
4561 E Florence Ave Fresno CA 93725
209 442-1048

Speakers VS

AURATONE CORP
PO Box 698 Coronado CA 92118
714 297-2820

Speakers VS

AUTOGRAM CORP
631 J Place PO Box 456 Plano TX 75074
214 424-8585

Computer/microprocessor automation controllers; audio consoles (stereo & mono multi-output studio, audio for TV) VS

AUTOMATED BROADCAST CONTROLS INC
See ABC Broadcast Controls

AUTOMATED BUSINESS CONCEPTS INC
See Broadcast Management Concepts

AUTOMATION ELECTRONICS INC
1001 South St Lafayette IN 47905
317 423-2572

Radio business automation systems

AUTOMATION TECHNIQUES INC
1846 N 106 E Ave Tulsa OK 74116
918 836-2584

Relay automation sequencers; random & automated VTR sequencers; helical non-servo capstan TBCs; digital clocks; multiple output video generators VS

AVAB AMERICA INC
967 Howard St San Francisco CA 94103
415 421-3562

Audio line amps; graphic equalizers & filters; portable audio consoles; hardwired intercoms; manual & automated lighting control systems; dimmer packs VS

AVA ELECTRONICS
4000 Bridge St Drexel Hill PA 19026
215 284-2500

Distribution amps, line extenders; coaxial connectors; camera & lens accessories; RF amps, attenuators and filters, cables and connectors, video attenuators, transmission lines and connectors; TV combiners VS

AVANTEK INC
3175 Bowers Ave Santa Clara CA 95051
408 249-0700

Microwave STLs; earth station LNAs

AVL DIGITAL LTD
70 Milner Ave Unit 5
Scarborough ONT M1S 3P8 Canada
416 298-6220

Video processing amps; video distribution & clamp amps; blackburst, stairstep/ramp & multiburst sync generator systems; video slaters VS

AVONIX DIV OF AV ELECTRONICS INC
PO Box 505 Brookfield WI 53005
414 784-1800

Videotape editor-controller; mini-console; production equip rental; post-production services; TV studio design

B

BACH AURICON INC
6950 Romaine St Hollywood CA 90038
213 462-0931

Heads, mounts & dollies; cine cameras & lenses

BALD MOUNTAIN LAB
230 Bellevue Rd Troy NY 12180
518 279-9753

Audio generators; dB meters VS

The Source '80

BALLANTINE LABORATORIES INC

PO Box 97 Boonton NJ 07005
201 335-0900
Frequency monitors and counters; dB meters; voltmeters; multimeters; oscilloscopes; digital panel meters VS

BARBIZON ELECTRIC CO INC

426 W 55 St New York NY 10019
212 586-1620
Lamps; lighting gels, sockets & accessories VS

BARDA ELECTRONIC INC

5340 Coolbrooke POB 175 Snowdon Montreal QUE H3X 3T4
514 486-0451
Character generators VS

BARDWELL & MCALISTER

7269 Santa Monica Blvd Hollywood CA 90046
213 876-4133
Camera tripods & accessories; lamps & lighting hardware; lighting plugs & connectors VS

BARKER & WILLIAMSON INC

10 Canal St Bristol PA 19007
215 788-5581
RF amps; audio test equip, RF coils; TVI filters, antenna switching unit, filament & plate chokes

BASF SYSTEMS

Crosby Dr Bedford MA 01730
617 271-4000
Audio tape (open reel, cartridges, cassettes); calibration tape; videotape; metal tape

BAYLY ENGINEERING LTD

(AEG-TELEFUNKEN)
167 Hunt St Ajax Ontario L1S 1P6
416 683-8200
Audio preamps, line & distribution amps, monitor & power supplies; portable audio consoles; RF amps; telco STLs; AM, FM, VHF & UHF transmitters; two-way radio communications; FM exciters; 19-inch equipment racks; surge protectors VS

BCS—See Kaman Sciences

BEAULIEU DIV OF BELL & HOWELL

See Bell & Howell Mamiya Co

BEAVERONICS INC

8 Haven Ave Port Washington NY 11050
516 883-4414
Large, small & portable production switchers; manual master control switchers; master & slave clocks; time dist. systems VS
See ad pg 161

BEBELL INC

MOTION PICTURE LAB DIVISION
416 W 45 St New York NY 10036
212 245-8900
Film lab services VS

BEI MICROELECTRONICS

1101 McAlmont Little Rock AR 72203
501 372-7351
Audio processing equip, equalizers and filters (active)

BELAR ELECTRONICS LABORATORY INC

119 E Lancaster Ave Devon PA 19333
215 687-5550
Modulators; RF amps; demodulators; AM stereo exciters; FM & TV SCA equip; frequency monitors & counters VS
See ad pg 199

BELDEN COMMUNICATIONS INC

534 W 25 St New York NY 10001
212 691-1910
Lamps; manual & automated lighting control systems; dimmer packs; lighting heads, stands & fixtures; diffusion material; gels & filters; production equipment rental services VS

BELDEN CORP (ELECTRONIC DIV)

PO Box 1980 Richmond IN 47374
317 983-5200
RF cable; audio cable; wire; transmission lines; coaxial cable VS

BELL & HOWELL (AV PRODUCTS DIV)

7100 McCormick Rd Chicago IL 60645
312 262-1600
Motion picture & slide projectors; projector lenses & accessories; overhead projectors; cassette recorders VS

BELL & HOWELL MAMIYA CO

1 Mamiya Dr Kensington Ctr Mt Prospect IL 60056
312 635-5000
Film cameras & lenses; camera accessories

BELL AUDIO SYSTEMS INC

994 Freeway Dr N Columbus OH 43229
614 846-2766
Audio amps (dist, preamps, power, public address); cartridge tape player/recorders (single) VS

BELL HELICOPTER TEXTRON

PO Box 482 Ft Worth TX 76101
817 280-2011
Helicopters VS
See ad pg 128

CA	7155 Valjean Ave Van Nuys	91406.....	213 787-3/80
CO	3033 S Parker Rd Suite 324 Aurora	80014.....	303 750-5990
GA	2200 N Lake Pkwy Suite 295	30084.....	404 938-6710
IL	451 Coventry Ln Crystal Lake	60014.....	815 459-6235
PA	27 S Commerce Dr PO 473 Montgomeryville	18930.....	215 368-6116
CAN	4826 11th St NE Calgary Alberta	Alberta T2E 2W7.....	403 276-7957
	2090 Walkley Rd Ottawa Ont	K1G 3V3.....	613 521-8320

BERKEY COLORTRAN INC

1015 Chestnut St Burbank CA 91502
213 843-1200
Lamps; heads, stands, and fixtures; diffusion material; plugs & connectors; light control systems (manual, auto, dimmer packs); patch terminals VS

BESTON ELECTRONICS INC (BEI)

Box 106A Olathe KS 66061
913 764-1900
Electronic titlers; teleprompters; automatic telecine light controls; video slaters; weather info. services VS

BEYER DYNAMIC INC

5-05 Burns Ave Hicksville NY 11801
516 935-8000
Headphones; full line mics, stands, booms & dollies; transformers VS
See ad pg 194

BGW SYSTEMS INC

13130 S Yukon Hawthorne CA 90250
213 973-8090
Audio preamps, monitor, power & dist amps; speakers VS

JAMES G. BIDDLE COMPANY

Township Line & Jolly Rds
Plymouth Meeting PA 19462
215 646-9200
Frequency meters; impedance bridges; multimeters VS

B I ELECTRONICS

128 Donaldson Center Greenville SC 29065
803 277-5985
Teletype alarm systems

BIRD ELECTRONIC CORP

30303 Aurora Rd Cleveland (Solon) OH 44139
216 248-1200
RF wattmeters; RF loads; RF filters; RF attenuators; RF converters; RF power monitor/alarms VS

BIRNS & SAWYER INC

1026 No Highland Ave Los Angeles CA 90038
213 466-8211
Camera heads, tripods, dollies; camera & lens accessories; film editing equip; lights & light stands; batteries; equip rental

BJA SYSTEMS INC

666 Davlsville Rd Willow Grove PA 19090
215 659-4141
Color video synthesizer; colorizer; animation equip; character/graphics systems; SEGs VS

B&K INSTRUMENTS INC—See Bruel & Kjaer Instruments Inc

BLONDER-TONGUE LABORATORIES INC

One Jake Brown Rd Old Bridge NJ 08857
201 679-4000
RF amps, loads, filters; FM & TV antennas; pay TV, CATV, MATV systems

BLOOMINGTON BROADCASTING CORP —

See Broadcast Management Systems

BOGEN—See Lear Slegler

BOGNER BROADCAST EQUIP CORP

401 Railroad Ave Westbury NY 11590
516 997-7800
FM, microwave & TV (HP & CP) transmitting antennas VS
See ad pg 142

BONNEVILLE BROADCAST CONSULTANTS

DIV
274 County Rd Tenafly NJ 07670
201 567-8800
Syndicated radio programming services VS

BONNEVILLE PRODUCTIONS

179 Social Hall Ave Salt Lake City UT 84111
801 237-2600
Audio dist & line amps; high speed tape duplication VS
See ad pg 96

BOONTON ELECTRONICS CORP

Rte 287 at Smith Rd Parsippany NJ 07054
201 887-5110
AM stereo & FM exciters; audio generators; impedance bridges; dB meters; RF wattmeters; voltmeters; waveform monitors and analyzers; AM, FM signal generators. VS

BORG-WARNER (INGERSOLL PRODUCTS DIV)

See Emcor

BOSCH FERNSEH

See Fernseh Inc.

BOSTON INSULATED WIRE & CABLE CO

65 Bay St Boston MA 02125
617 265-2102
Connectors; wire & cable VS

BOSTON SOUND AND POWER SYSTEMS

3 Fredith Rd Weymouth MA 02189
617 335-8709
Audio line, dist, monitor & preamps; amp power supplies; automation controllers & systems; LED audio level indicators; radio computer business services

BOZAK INC

587 Connecticut Ave S Norwalk CT 06854
203 838-6521
Amps (preamps, monitor, power, public address); equalizers & filters (passive); delay lines

BPI AUDIO TEST EQUIP

7853 Balboa Ave San Diego CA 92111
714 279-3344
Vollmeters; dB meters; harmonic distortion meters; audio generators; load banks; intermodulation meters; wow & flutter meters VS

BRAND-REX CO

PO Box 498 Willimantic CT 06226
203 423-7771
Flexible transmission line, coaxial cable, wire & cable

VS MEANS IT'S VERIFIED

Marconi's total system capability...



starts with the Mark IX Camera



MR-2/MR-20
1" C Format
New! Half Speed Playback
Capability Option

Features include:
AST,* allows the MR-2 to
replay at any speed from
still frame to normal,
manual jogging,
shuttle speeds for ease
editing ...

Plus:

- MTBC2 time base corrector
- Video tape monitoring unit

*TM of Ampex Corp.

At Marconi, we constantly strive to excel in bringing significant advances to the broadcast industry. That's why we introduced the MARK IX ... a second generation modular camera that can be tailored to your exact requirements. The unique design is centered around two camera heads and a common CCU. The heads offer both automatic and manual features and all the options are compatible and interchangeable. With the Mark IX you are assured of the highest quality... in the studio or the smallest van.

Whether your interest is 1 inch VTR's, cameras, transmitters, or digital standard converters ... call MARCONI ... our experience is available to you.

FOR SALES INQUIRIES CALL:

A.F. Associates (201) 767-1000

Marconi Electronics, Inc.

100 Stonehurst Court • Northvale, NJ 07647

Circle 144 on Reader Service Card

The Source '80

BRETTFORD MFG CO

9715 Soreng Ave Schiller Pk IL 60176
312 678-2545

Mobile audio equipment stands; audio tape, cart & cassette storage; videotape storage; VTR security centers, cabinets & stands; cabinets & furniture

BROADCAST AIDS INC

20 Red Rose Dr Levittown PA 19056
215 547-7133

Digital clocks; timers

VS

BROADCAST AUDIO CORP

11355 Pyrites Way Rancho Cordova CA 95670
916 635-1048

Audio line, monitor & preamps, power supplies; graphic equalizers & filters; audio consoles (stereo multi-output studio, audio for TV, automated)

VS

BROADCAST AUTOMATION ASSOCIATES INC

PO Box 277 4100 Metzger Rd Ft Pierce FL 33450
305 465-3911

Audio equipment; radio studio design; facility turnkey installation

BROADCAST CARTRIDGE SERVICE

15131 Triton Ln Ste 108 Huntington Beach CA 92649
714 898-7224

Tape cartridges; empty reels, carts, cassettes; cartridge tape storage; tape cleaning & evaluating service

VS

BROADCAST ELECTRONICS INC

4100 N 24 St PO Box 3606 Quincy IL 62301
217 224-9600

Audio line, distribution & preamps; rotary & slide attenuators; ALC & AGC amps; AM & FM compressor/limiters; audio delay systems; relay & time insertion sequencers; computer automation controllers; complete automation systems; consoles (one-output mic mixers, portable, mono & stereo multi-output studio, audio for TV); turntables; pickup arms and phono cartridges; mics (dynamic, condenser/electret, wireless, shotgun, lavalier); mic stands, booms & dollies; patch panels; speakers; open-reel audio tape, carts & cassettes; empty reels, leader tape, tape timers, tape cleaners, rewinders; alignment gauges; cart player/recorders (single, dual, multiple, time delay); open-reel recorders (portable, studio, time delay); replacement tape heads; splicing blocks & tape; head degaussers; bulk & conveyor erasers; cart storage; telephone coupling equip; video distribution amps; FM exciters; remote control systems; remote pickup equip; FM transmitters; digital clocks; master & slave clocks; FM, AM, TV field intensity meters; wow & flutter meters; EBS two-tone systems

VS

BROADCAST MGT CONCEPTS INC

7204 Clairemont Mesa Bl San Diego CA 92111
Radio computer business services

BROADCAST PROGRAMMING INTL

PO Box 2027 Bellevue WA 98009
206 454-5010

Syndicated radio programming services

VS

See ad pg 201

BROADCAST SERVICES CO

PO Box 85 Selma NC 27576
919 284-2102

Digital timers; radio equip sales

BROADCAST VIDEO SYSTEMS LTD

1050 McNicoll Av Toronto ONT M1W 2L8
416 497-1020

RGB, luminance & encoded chroma keys; color correctors; color encoders; production switchers (small, portable); special effects gens; video delay lines & filters; comb decoders; vectorscopes; waveform monitors & analyzers; safe area generators; pulse width test set

VS

See ad pg 200

CA 1438 N Gower # 560 Hollywood
90028..... 213 460-2949

BRUEL AND KJAER INSTRUMENTS INC

185 Forest St Marlborough MA 01752
617 481-7000

Condenser/electret mics; stands, booms, dollies mics; chart recorders; audio generators; harmonic distortion meters; intermodulation meters; oscilloscopes; phase meters; spectrum analyzers; voltmeters; multimeters; dB meters; waveform monitors & analyzers; wow & flutter meters

BRUSH MAGNETIC HEADS

PO Box 638 Sunbury PA 17801
717 286-5611

Replacement tape heads

VS

BSC INC

2932 River Road River Grove IL 60171
312 452-5551

Cabinets

BSM SYSTEMS

2646 E 37 Ave Spokane WA 99203
509 448-0697

Portable mixing consoles

VS

See ad pg 150

BTX CORP

12 Huron Dr Natick MA 01760
617 653-6811

Computer/microprocessor automation controllers; SMPTE time code synchronizing systems; SMPTE audio/video recorder synchronizers; SMPTE time code readers & generators; jam-sync generator readers; manual & automatic audio/videotape editing systems; computerized electronic videotape editing systems

VS

See ad pg 176—refer to resp/dist section

CA J. Hudspeth 6255 Sunset Blvd
Ste 810 Los Angeles 90028..... 213 462-1506

BUHL OPTICAL

1009 Beech Ave Pittsburgh PA 15233
412 321-0076

Film telecine slide projectors & multiplexers

VS

BULOVA WATCH CO INC AM TIME PRODUCTS DIV

61-20 Woodside Ave Woodside NY 11377
212 335-6000

Studio clock systems & frequency standards

BURDEN ASSOCIATES

20944 Sherman Way Canoga Pk CA 91303
Facility turnkey installation; radio studio design

VS

BURNS AUDIOTRONICS — See Beyer Dynamic Inc

C

CABLEWAVE SYSTEMS INC

60 Dodge Ave N Haven CT 06473
203 239-3311

ENG microwave; RF phasing networks; RF cables; RF connectors; RF switchers; microwave STLs; microwave antennas; transmission line & connectors

VS

CALICO VIDEO CO INC

PO Box 2405 Stockton CA 95201
209 952-3333

Videotape; reels; cartridges; reloaded carts

CALIFORNIA INSTRUMENTS

5150 Conroy St San Diego CA 92111
714 279-8620

Voltmeters, multimeters; oscilloscopes; ac power converters; frequency changers

CALIFORNIA MICROWAVE INC

990 Almanor Ave Sunnyvale CA 94086
408 732-4000

Transmit/receive satellite earth stations; demodulators; program demultiplexers

VS

See ad pg 134

NJ R deCamp PO Box 126
Lincroft..... 201 671-2759

CALVERT ELECTRONICS INC

220 E 23 St New York NY 10010
212 481-5300

Camera pickup tubes; rectifiers; power tubes

VS

CAMBRIDGE PRODUCTS CORP

244 Woodland Ave Bloomfield CT 06002
203 243-1761

RF and audio cables & connectors

VS

THE CAMERA MART

456 W 55 St New York NY 10019
212 757-6977

TV production equipment rental; small production switchers

VS

See ad pg 129

CANADIAN GENERAL ELECTRIC CO LTD

396 Attwell Dr Rexdale Ont M9W 5C3 Canada
416 675-7500

Diplexers; HP TV antennas; translators; VHF & UHF TV transmitters

VS

CANON USA INC

10 Nevada Dr Lake Success NY 11042
516 488-6700

Video camera lenses, cine camera lenses, camera controls and accessories

VS

See ad pg 158

CA Canon USA 123 Paularino Ave E Costa
Mesa 92626..... 714 979-6000
IL Canon USA 140 Industrial Drive
Elmhurst 60126..... 312 833-3070

CANDEX PACIFIC

693 Veterans Blvd Redwood City CA 94063
415 364-8427

Design custom electronic equip

CAPITOL MAGNETIC PRODUCTS

DIV OF CAPITOL RECORDS

6902 Sunset Blvd Hollywood CA 90028
213 462-2701

Audio cartridges & cassettes

VS

See ad pg 122

CA 1777 N Vine St Los Angeles
90028..... 213 462-6252
IL 6401 Gropp Point Rd Niles
60648
NY 1370 Ave of the Americas NY
10019..... 212 757-7470
TX 6730 Pakbrook Blvd Dallas
75235..... 214 637-1890

CASES INC

1745 W 134 St Gardena CA 90249
213 770-4444

Racks, cases (shipping, storage & carrying); cabinets

CATEL DIV UNITED SCIENTIFIC CORP

1400 D Sterlin Rd Mountain View CA 94043
415 969-9400

FM modulators & demodulators; FM microwave subcarrier systems; TV modulators; filters; video FM link

VS

CATERPILLAR TRACTOR

100 NE Adams Peoria IL 61629
309 675-1000

Emergency power generators

CAT SYSTEMS

401 E 74 St New York NY 10021
212 988-0658

Automation controllers, computer/microprocessor; complete automation systems; remote control systems; process control with color graphics display

VS

CAVOX-TAPEATHON CORP

502 S Isis Av Inglewood CA 90301
213 776-6933

Automation sequencers, relay & time insertion; complete automation systems; auto time/weather announcers; tape duplicating services; portable & studio open-reel tape player/recorders; syndicated radio programming services

VS

CBS TECHNOLOGY CENTER

227 High Ridge Rd Stamford CT 06905
203 327-2000

Test records

VS

CCA ELECTRONICS CORP

Box 5500 Cherry Hill NJ 08034
609 424-1500

AM, FM, UHF & VHF transmitters; FM exciters

VS

NEC DME® System features:

- Single or dual channel operation with DME dual system for simultaneous single-studio multi-channel or two-studio single channel use.
- Complete frame synchronization on all inputs including TBC, freeze and Velcomp capabilities.
- Intelligent digital control system with 18 complete memory locations of start and finish position/size and special effects.
- Automatic pan and tilt control with limit for not going out of frame.
- New vertical and horizontal inversion effects including "tumble" using new digital control.
- New "mosiac" effect with adjustable tile size for dramatic visualization of show openings and closings.
- TTL pulse circuitry for sequential and external triggering to permit extensive interface with editors and other creative controllers.

NEC DME Control features:

- Operation with DME or existing DVE® Digital Video Effects System for full digital control of all system functions.
- Memory capacity for 18 complete pattern manipulations including start position and size, finish position and size, posterization and

- solarization effects, freeze frame or freeze field and real time frame entry of effect duration ... all effects instantly and exactly repeatable.
- Automatic pan and tilt functions with selectable limit to prevent pattern transition beyond blanking.
- Memory reveal function to permit image-track effects by revealing the entire memory and removing normal mask.
- Bridging of all memories to permit multiple effect sequences up to 999 frames each for a total capacity of 17,982 frames of pre-programmed effects.
- Auto-freeze for pre-timed incremental freezing.
- All digital construction including digital shaft encoder instead of conventional faders.

NEC

NEC America, Inc.

Broadcast Equipment Division
130 Martin Lane
Elk Grove Village, IL 60007

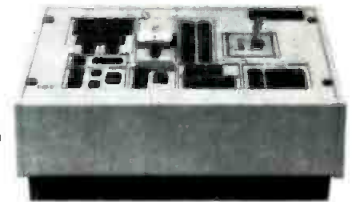

*Registered Trademark 1980

NEC INTRODUCES THE MOST FLEXIBLE DIGITAL EFFECTS SYSTEM AVAILABLE!

All digital control
All function memories
All DVE compatible

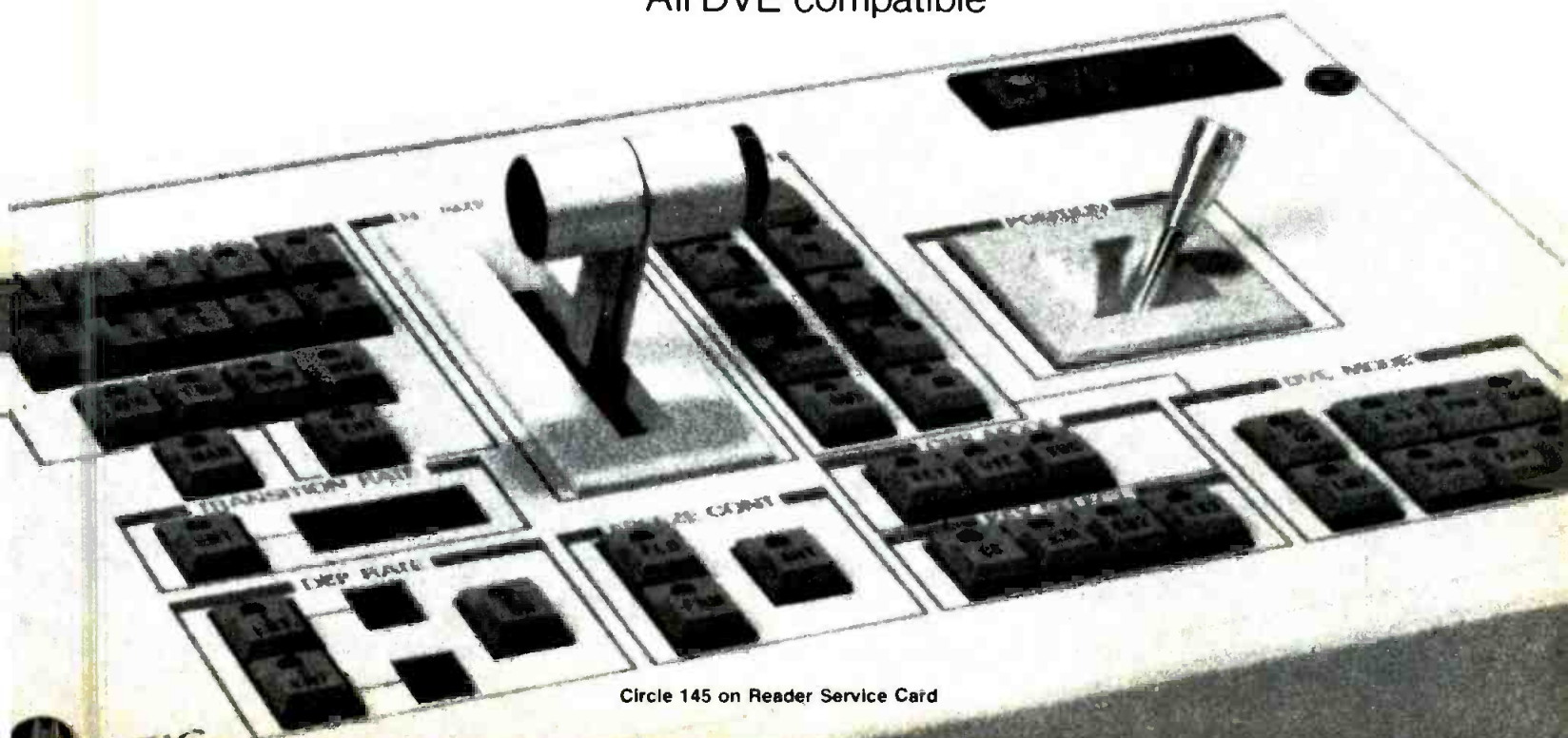

Circle 145 on Reader Service Card

Protect your Video investment with the strength of ANVIL Cases!

If your equipment is constantly on the road—or in the air—rugged, dependable ANVIL® Cases will make sure it arrives in performance-ready condition every time. We have a Case design to fit any Video component on the market. And we can customize your Case to carry those all-important cords, cables and connectors too!

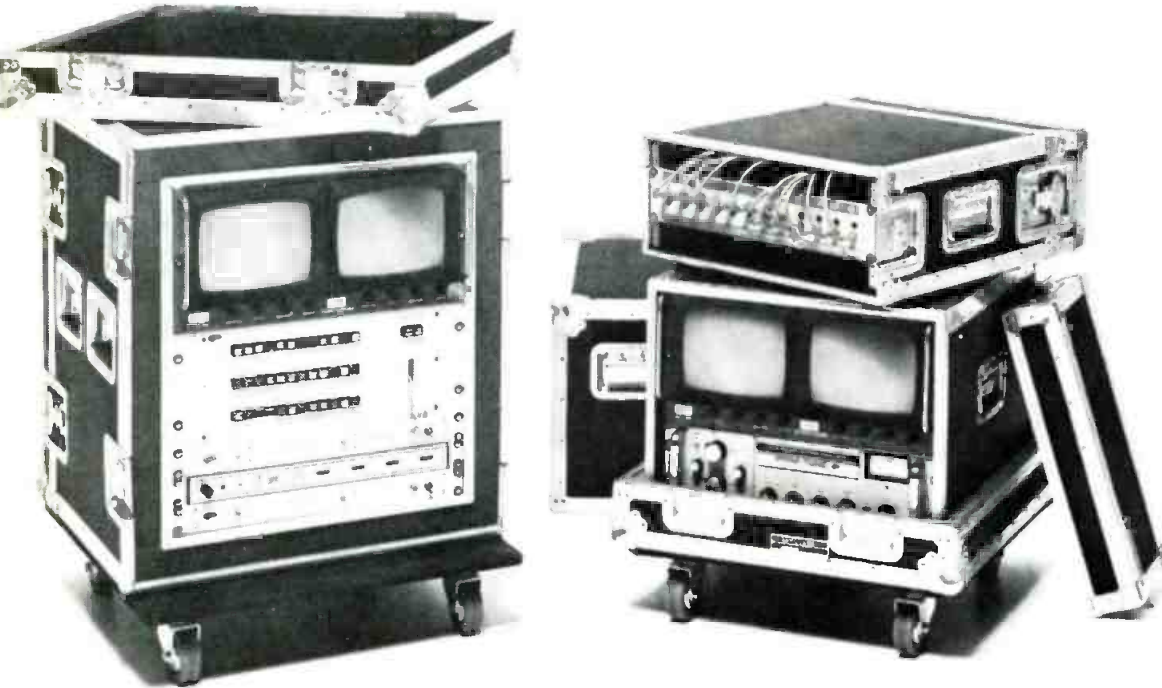

VIDEO RACK-MOUNT CASES ANVIL makes three types of Video Rack-Mount Cases. Shown at left is our all-new "Shock-Mount" design—the industry's first true shock-isolation Travel Case. Double plywood walls are separated by a 2-inch layer of high-density polyfoam. Upper-right is our standard Front and Rear Clamp-On Lid style. Shown lower-right is our Pull-Over Clamp-Lid style, featuring an open front and back rack-shell, which fits into a standard 1-inch foam-lined Pull-Over Clamp-Lid style Case.



RECORDER CASES We make a strong Case for every video recording unit on the market. It's the best way to protect delicate alignment and calibration settings during transit.



COMBINATION/CAMERA RECORDER CASES Now any manufacturer's Camera can be safely transported with any recording unit. Once on location, just open the Case—hook up—and shoot!

For more information and the location of your nearest ANVIL® Dealer—call or write:
ANVIL® CASES, INC., 4128 Temple City Blvd., (P.O. Box 888), Rosemead, CA 91770 (213) 575-8614

Circle 147 on Reader Service Card

ANVIL



The Source '80

COMPREHENSIVE VIDEO SUPPLY CORP

148 Veterans Dr Northvale NJ 07647
201 767-7990

Audio dist amps; headphones; RF intercom systems; condenser/electret, shotgun, lavalier mics, stands, booms & dollies; magnetic tape cartridges & cassettes; tape timers & tape cleaners; tape editing & splicing blocks & tape; tape head degaussers & bulk erasers; tape cassette storage; video camera heads & tripods; ENG camera braces & dollies; video camera lenses & power packs; video dist amps; sync, color bar, blackburst & stairstep/ramp generator systems; video equipment carrying cases, test charts & slides; new videotape; videotape cleaners, VTR head cleaners & bulk erasers; cine camera tripods & accessories; lamps; lighting hardware & accessories; plugs & connectors; prefab scenery; seamless materials; RF cables & connectors; digital clocks & timers; video generators; oscilloscopes; battery supplies for production equipment; battery chargers; cabinets & enclosures; audio & radio connectors; wire & cable **VS**

See ad pg 95

COMPUTER BUSINESS SYSTEMS INC

167 Moore Rd Weymouth Ind Pk Weymouth MA 02189

617 337-7799

Radio and TV business computer services/equipment; newsroom computers

COMPUTER CONCEPTS

8001 W 63 St Shawnee Mission KS 66202
913 677-4000

Computer/microprocessor automation controllers; business computer services/equip for radio **VS**

COMPUTER IMAGE CORP

2475 W 2nd Ave Ste 4 Denver CO 80223
303 934-5801

Electronic animation

COMPUTER LABS DIV ANALOG DEVICES INC

505 Edwardia Dr Greensboro NC 27409
919 292-6427

A/D converters; D/A convertors

COMPUTER MANAGEMENT SYSTEMS INC

6610 N Shadeland Ave Indianapolis IN 46220
317 846-1830

Business computer services/equipment for radio & TV

COMQUIP INC

366 S Maple Glenrock NJ 07452
201 444-3800

Distributor of studio cameras, ENG/EFP cameras, camera lenses and accessories, tripods and dollies, telecine equipment, monitors, video processing equip, small production switchers, SEGs; VTRs; film equip

COMREX CORP

PO Box 269 Sudbury MA 01776
617 443-8811

Wireless mic systems; low frequency extenders; RF intercoms; telephone coupling equipment; receivers, command monitor; remote pickup equipment **VS**

See ad pg 18

COMSEARCH INC

7633 Leesburg Pike Falls Church VA 22043
703 356-9470

Interference analysis service for satellite earth stations and STLs **VS**

COMTECH ANTENNA CORP

3100 Communications Rd St Cloud FL 32769
305 892-6111

Satellite earth stations (transmit/receive, receive-only, mobile); communications & microwave antennas; CP TV antennas; towers; geodesic radomes **VS**

CONCEPT PRODUCTIONS

801 D Riverside Ave Roseville CA 95678
916 782-7754

Syndicated radio programming services **VS**

CONRAC CORP

1800 N Rimsdale Ave Covina CA 91722
213 966-3511

TV monitors **VS**

See ad pg 136—refer to rep/dist section

CA W Eims 600 N Rimsdale Ave
Covina 91722 213 966-3511
IL J Keenan 627 N York Rd Elmhurst
60126 312 833-3310
NJ R Sanford 85 Orient Way Rutherford
07070 201 939-8444
TX F DuVal 2925 LBJ Fwy Ste 157
Dallas 75234 214 243-1834
CAN B Mitchell 345 Kingston Rd Ste 210 Pickering
Ontario L1V 1A1 416 281-3215

CONRAC CORP SYSTEMS EAST DIV

32 Fairfield Pl W Caldwell NJ 07006
201 575-8000

Large screen projectors **VS**

CONSOLIDATED ELECTRONIC INDUSTRIES INC

Waterview Bldg Ste 906 1925 N Lynn St
Arlington VA 22209
703 524-9811

Radio automation equip. (studio systems, open-reel decks, controllers, cart decks, read out/display data input devices, complete systems) **VS**

CONSOLIDATED VIDEO SYSTEMS — See Harris Video Systems

CONTINENTAL ELECTRONIC (CONTEL)

1620 W 32 PI Hialeah FL 33012
305 822-1421

Tape cartridge single player/recorders

CONTINENTAL ELECTRONICS MFG CO

PO Box 270879 Dallas TX 75227
214 381-7161

High-power AM broadcast transmitters; RF phasing networks; RF loads **VS**

See ad pg 105

CONTROL VIDEO CORP

578 Division St Campbell CA 95008
408 866-7447

SMPT E audio/video recorder synchronizers; full line SMPT E time code equip; two-VTR editor/controller **VS**

CONVERGENCE CORP

1641 McGaw Irvine CA 92714
714 549-3146

SMPT E time code synchronizing systems; electronic audio tape editors; SMPT E time code readers; video special effects gens; video animation; two-VTR editor/controllers; multi-source video editors; computerized auto-assembly editors **VS**

See ad pg 91

COOPER GROUP ELECTRONICS DIV

PO Box 728 Apex NC 27502
919 362-7511

Soldering guns, wire stripping tools, hardware; hand tools

COPPERWELD BIMETALLICS GROUP

Robinson Plaza II Pittsburgh PA 15205
412 777-3000

Tower hardware & construction equipment **VS**

D & S CORLEY LTD

80 Galaxy Blvd Unit 3 Rexdale Ontario M9W 4Y8
Canada
416 675-3511

Telecine test materials, video test generators **VS**

COX DATA SERVICES

Suite 100 Prado N 5600 Roswell Rd NE Atlanta
GA 30342
404 256-5200

Computer systems for TV and CATV **VS**

COYNE ASSOC

1010 Sherbrook St W Ste 307 Montreal Que
H3A 2R7 Canada
514 282-8027

Computer aided systems design for CATV;

broadband consulting service

CPAC INC

2364 Leicester Rd Leicester NY 14481
716 382-3223

Silver recovery and pollution control systems

CROMPTON INSTRUMENTS INC

2763 Higgins Rd Elk Grove Village IL 60007
312 593-1107

VU & PPM audio level indicators; voltmeters; dB meters; transformers

CROSSPOINT LATCH CORP

316 Broad St Summit NJ 07901
201 273-1090

Encoded chroma keyers; production switchers; special effects generators; sync, color bar, black burst generator systems; colorizers; computer-controlled effects systems; portable switcher in a case; monitor packages; custom-built switchers **VS**

See ad pg 131

CROWN INTL INC

1718 W Mishawaka Rd Elkhart IN 46517
219 294-5571

Audio preamps, line amps, monitor & power supplies, dist amps; equalizers & filters, parametric & graphic; automation controllers, computer/microprocessor; condenser/electret mics **VS**

CSI ELECTRONICS INC

3800 S Congress Ave Boynton Beach FL 33435
305 737-5626

Transmitters (AM, FM, carrier current); status and alarm indicators; stereo and SCA generator **VS**

See ad pg 193

CSP INC

203 Airport Rd Doylestown PA 18901
1 800 523-6010

Diplexers; RF phasing networks; RF amps, attenuators, converters, switchers, loads & filters; antenna tuning units; DA equip; transmission line & connectors; towers; tower hardware & construction equip; tower lighting; antenna monitors; impedance bridges; phase meters; RF gaskets & inductors; insulation coils, RF contactors; capacitors; static drain chokes; antenna loops & sampling systems **VS**

CUSTOM AUDIO ELECTRONICS — See Rainbow Products

CUSTOM BUSINESS SYSTEMS INC

Box 67 Reedsport OR 97467
503 271-3684

Business computer services for radio **VS**

D

3D TELEVISION

4382 Lankershim Blvd N Hollywood CA 91602
213 769-6777

3D cameras & display systems; large screen projectors **VS**

DABURN ELECTRONICS & CABLE CORP

70 Oak St Norwood NJ 07648
201 768-5400

Wire and cable; audio, radio & electrical connectors; shrink tubing & sleeving; terminals **VS**

DAGE-MTI INC

208 Wabash St Michigan City IN 46360
219 872-5514

TV mono cameras; b&w picture monitors; studio production center/mono audio mixer; video pulse & distribution amps; sync generator systems; small production switchers; CCTV systems **VS**

PETER W DAHL CO INC

4007 Fort Blvd El Paso TX 79930
915 566-5365

Transformers **VS**

DAK INDUSTRIES INC

10845 Vanowen St N Hollywood CA 91605
213 984-1559 800 423-2636

Audio tape (open reel, cartridges); empty reels, carts & cassettes; leader tape; new videotape; audio tape duplication services

The Source '80

EDCOR DIV OF PAC

16782 Hale Ave Irvine CA 92714
714 556-2740

Audio amps (distribution, line, preamps, public address); microphones (condenser, wireless, lavalier); headphone amps

EDUTRON INC

11003 US Highway 19 Roswell GA 30075
404 992-1626

Dropout compensators; image enhancers; sync generator systems; TBCs (helical capstan servo & helical non-servo capstan) VS

EEOC INC

1601 E Chestnut Ave Santa Ana CA 92701
714 835-6000

SMPTE time code audio systems; electronic audio editors; SMPTE A/V recorder synchronizers; SMPTE time code readers/gens; two-VTR editor/controllers; multi-source & computerized video editors VS

Products distributed by Ampex

See ad pg 35

EEG ENTERPRISES INC

1 Rome St Farmingdale NY 11735
516 293-7472

Encoders and decoders for closed caption video transmission in line 21 VS

EEV INC

7 Westchester Plaza Elmsford NY 10523
914 592-6050

RF tubes; vacuum tubes; camera pickup tubes; rectifiers; surge protectors; vacuum capacitors; klystrons, Leddicons; digital clocks; character/graphics displays VS

See ad pg 69

GA	H Kozicki 15 Dunwoody Park Ste 100E Atlanta 30338	404 394-9201
IL	C Bocan Z073 Arleen Ct Schaumburg 60194	312 843-8417
TX	R Knowles Rt 1 Anna 75003	214 837-2464
WA	D Rose 19001 40th Pl NE Seattle 98155	206 363-2200

EEV CANADA LTD

67 Westmore Drive Rexdale Ontario M9V 3Y6
416 745-9494

RF tubes, vacuum tubes, camera pickup tubes, rectifiers, surge protectors, vacuum capacitors; klystrons, Leddicons; digital clocks; character/graphics displays VS

EG&G

35 Congress St Salem MA 01970
617 745-3200

Obstruction lighting; tower lighting VS
See ad pg 104

EIDSON ELECTRONIC CO

PO Box 96 Temple TX 76501
817 773-3901

Quartz crystals for frequency control VS

EIGEN VIDEO

PO Box 1027 Grass Valley CA 95945
916 273-1341

Splicing blocks & tape; slow motion video action recorders; variable speed and time lapse videoaction recorders VS
See ad pg 200

EIMAC DIV OF VARIAN

301 Industrial Way San Carlos CA 94070
415 592-1221

Complete line of broadcast, quality power grid tubes (triodes, tetrodes, pentodes) VS

See ad pg 38

AL	500 Wynn Dr NW Ste 301F Huntsville 35805	205 837-9225
AZ	7117 3 Ave Ste 107 Scottsdale 85251	602 947-5461
CA	375 Distel Cir Ste C4 Los Altos	415 968-7630
	2901 Wilshire Blvd Ste 205 Santa Monica 90403	213 828-5588
FL	314 S Missouri Ste 307 Clearwater 33516	813 446-8513

GA	United Finance Bldg Ste 4 1600 Watson Blvd Warner Robins 31093	912 922-2202
IL	205 W Touhy Ave Pk Ridge 60068	312 825-6686
MA	83 2 Ave Burlington 01803	617 272-8532
MD	4701 Lydell Rd Cheverly 20781	301 773-7010
NJ	25 Commerce Dr Cranford 07106	201 276-9050
	306 Fellowship Rd Mt Laurel 08056	609 235-6800
NY	6489 Ridings Rd Syracuse 13206	315 437-2568
OH	4134 Linden Ave Ste 101 Dayton 45432	513 258-3930
TX	13531 N Central Expwy Ste 2343 Dallas 75243	214 235-2385
CAN	45 River Dr Georgetown Ont L7G 2J4	416 457-4130

EIP MICROWAVE

3230 Scott Blvd Santa Clara CA 95051
408 244-7975

Microwave and FM frequency counters and monitors

ELCOM SPECIALTY PRODUCTS INC.

2810 Redding Ave # E Sacramento CA 95820
916 453-0859

ALC & AGC amps; AM & FM compressor/limiter/filters; AM Combiners, 1-1000 kW (ferrite); RF loads; tower lighting VS
See ad pg 152

ELECTRA CO DIV OF MASCO OF INDIANA

300 E County Line Rd Cumberland IN 46229
317 894-1440

Automatic scanning monitors

ELECTRO ACOUSTIC DESIGNS INC

PO Box 419 Kingston RI 02881
401 789-1329

Studio design; audio system design and installation; acoustical design and construction VS

ELECTRO CONTROLS INC

2975 So 300 West Salt Lake City UT 84115
801 487-9861

Lighting heads, stands & fixtures; manual & automated light control systems & dimmer packs; patch terminals, plugs and connectors

ELECTROHOME LTD

809 Wellington St N Kitchener ON CAN N2G 4J6
519 744-7111

Color & monochrome monitors; large screen projectors VS

ELECTRO IMPULSE INC

116 Chestnut St Red Bank NJ 07701
201 741-0404

RF attenuators, loads, wattmeters VS
See ad pg 177 — refer to rep/dist section

ELECTRONEERING INC — See Broadcast Services Co

ELECTRONIC DEVICES INC

21 Gray Oaks Ave Yonkers NY 10710
914 965-4400

Rectifiers; solid state components VS

ELECTRONIC MUSIC LABORATORIES

PO Box H Vernon CT 06066
203 875-0751

Music synthesizers VS

ELECTRONICS DIVERSIFIED

1675 NW 216 St Hillsboro OR 97123
503 645-5533

Lighting control systems (manual, automated, dimmer parts); lighting heads, stands & fixtures; patch terminals VS

ELECTRONICS MISSILES & COMMUNICATIONS INC — See EMCEE

ELECTRO & OPTICAL SYSTEMS LTD

31 Progress Ct Scarborough ONT M1G 3V5
416 439-9333

SMPTE time code synchronizing system; PPM audio level indicators; SMPTE audio/video recorder synchronizers; SMPTE time code readers & generators VS

ELECTRO SOUND INC

160 San Gabriel Dr Sunnyvale CA 94086
408 245-6600

Tape auto loaders, splicing blocks, open-reel tape recorders, (portable and studio), tape duplicators

ELECTRO-VOICE INC

600 Cecil St Buchanan MI 49107
616 695-6831

Mics (dynamic, condenser, shotgun, lavalier); mic booms and dollies; audio connectors VS

See ad pg 10 — refer to rep/dist section

CA	E-V West 7473 Ave 304 Visalta 93277	209 625-1330
CAN	E-V 345 Herbert St Gananoque Ontario	613 382-2141

ELPA MARKETING INDUSTRIES INC

Atlantic & Thorens Aves New Hyde Park NY 11040
516 746-3002

Turntables (Thorens)

EMCEE BROADCAST PRODUCTS

PO Box 68 White Haven PA 18661
800 233-6193

FM amps; translators; VHF & UHF TV transmitters; HP TV antennas VS

EMCOR PRODUCTS

1600 4 Ave NW Rochester MN 55901
507 289-3371

Racks and cabinets

EMERGENCY ALERT RECEIVER INC

1 W 30 St New York NY 10001
212 695-4761

EBS two-tone systems; receivers, comm & monitor; FM SCA equip VS

EMS UNEMCO INTL INC

1392 Borregas Ave Sunnyvale CA 94086
408 734-0163

Two-VTR editor/controller; multi-source videotape editors; computerized auto assembly editors; SMPTE time code readers VS

See ad pg 141

CA	UNEMCO Intl 9183 Chesapeake Dr San Diego 92123	714 565-8973
----	---	--------------

ENCLOSURE CORP

4529 Adams Cir Cornwells Hts PA 19020
215 638-9550

19-inch equip racks; cabinets & furniture VS

ENGLISH ELECTRIC VALVE CO — See EEV

E-N-G CORPORATION

10009 A Shary Cir Concord CA 94518
415 798-4060

Mobile van construction; transmission line & connectors VS
See ad pg 202

ENG HELICOPTER SATELLITES LTD

7920 Airpark Rd Gaithersburg Md 20760
301 948-5018

ENG/EFP camera systems; camera stabilizing systems and shoulder braces; diplexers; ENG & airborne microwave equip; microwave supports & portable equip; comm & microwave antennas; 19-inch equip racks; cabinets & furniture; electrical connectors; inverters VS

ENTERPRISE ELECTRONICS CO

PO Box 1216 Ind Blvd Enterprise AL 36330
205 347-3478

Weather radar systems

ESC ELECTRONICS

534 Bergen Blvd Palisades Pk NJ 07650
201 947-0400

Delay lines, RF filters

ESE

142 Sierra St El Segundo CA 90245
213 322-2136

LED audio level indicators; SMPTE time code readers; digital clocks; master & slave clocks; timers; time distribution systems; EBS two-tone systems; dB meters VS

See ad pg 183—refer to rep/dist section



THE STUDER 069. A STUDIO IN A SUITCASE.

Wherever you're on the spot, the Studer 069 gives you everything you need. Fast. Mixer, limiter, telephone and broadcast line feeds, mikes, cables, monitor phones. All in a single suitcase or permanently parked in your mobile van. A two-minute set-up for sports coverage, interviews,

fast-breaking stories. Without jury-rigged lash-ups between multiple units to cause "technical difficulties."

The unique 069 Commentator Box gives you a single-run connection for two mikes, phones, or mike/phone combos, with full talkback and separate cue facilities. The mixer unit provides the engineer with complete telephone initiate/monitor facilities (local battery or central office powered) for dial system, balanced program line and radio link feeds. You can run the 069 from an AC power line, self-contained

NiCads, or a 12V car battery for complete operating freedom.

Two mike/line inputs and a separate recorder feed are individually assignable to either or both output channels, and all three have selectable low-cut and presence EQ. Four 6-way monitor switches and volume controls give both engineer and commentator the exact signal they need to hear in each ear.

The 069 is Studer's complete go-anywhere, be-prepared-for-anything answer for broadcast remotes. For a full descriptive brochure, contact Studer Revox directly.

STUDER REVOX

Studer Revox America, Inc.
1425 Elm Hill Pike
Nashville, TN 37210, (615) 254-5651
Offices: LA (213) 780-4234; NY (212) 255-4462



Circle 149 on Reader Service Card

CONSULTING ENGINEER

CONSULTING ENGINEER needed to design telecommunications delivery system for KVCR-TV, Channel 24 (public), San Bernardino, CA. Design is needed for replacement and relocation of transmitter and necessary support technologies to extend coverage to outlying areas. Write or call by September 25, 1980 for details:

Fred Burgess or Judith Hert
San Bernardino Community
College District
701 South Mt. Vernon Avenue
San Bernardino, California 92410
(714) 888-6511 Extension 127

An Equal Opportunity Employer

MAP AUDIO DISTRIBUTION AMPLIFIERS

**IMPAC
SERIES
MODEL
4820**

(1 x 8)

MODULAR PC - CARD SYSTEM
UP TO 16 CARDS PER FRAME



LINE IN MODEL 7821
SINGLE INPUT X 8 OUTPUTS
19 INCH RACK MOUNTING WITH
BUILT-IN POWER SUPPLY

LINE IN MODEL 7822
DUAL CHANNEL (2 X 8) OR (1 X 16)

MIC OR LINE IN MODEL 7823
SINGLE INPUT X 8 OUTPUTS

For prompt assistance call or write



Manufacturers of ■ CONSOLES
■ CONSOLE/SYSTEM COMPONENTS

**MAP MODULAR
AUDIO PRODUCTS**

A UNIT OF MODULAR DEVICES, INC.

50 Orville Drive • Airport International Plaza
Bohemia, N.Y. 11716 • (516) 567-9620

Circle 220 on Reader Service Card

90 BME SEPTEMBER, 1980

The Source '80

EUMIG (USA) INC

Lake Success Business Pk 225 Community Dr
Great Neck NY 11020
516 466-6533

Audio preamps, line amps, monitor & power
supplies; audio cassettes; computer-controlled
audio cassette deck; 16 mm cine cameras & lenses;
receivers, comm & monitor VS
See ad pg 185 — refer to rep/dist section

EVENTIDE CLOCKWORKS INC

265 W 54 St New York NY 10019
212 581-9290

AM compressor/limiters; audio delay systems &
special effects; spectrum analyzers VS

EXCALIBUR INDUSTRIES

12251 Foothill Blvd Lake View Terr CA 91342
213 899-2547

Video equip carrying cases; film cases VS

E-Z WAY PRODUCTS INC

PO Box 22845 Tampa FL 33622
813 677-7144

Towers

F

FAIRCHILD CAMERA & INSTRUMENT CORP CCD IMAGING DIV

4001 Miranda Ave Palo Alto CA 94304
415 493-3100

Video delay lines VS

FARINON VIDEO

1680 Bayport Ave San Carlos CA 94070
415 595-3500

Diplexers; microwave equip (ENG, intercity,
portable, airborne); RF amps, microwave STLs VS
See ad pg 127

CAN 657 Orly Ave Dorval PQ H9P 1G1 514 636-0974

FAROUDJA LABS

946 Benicia Ave Sunnyvale CA 94086
408 245-1492

Image enhancers; color monitors; video filters;
video film noise reducers; comb decoders VS
See ad pg 147

F&B CECO INC

315 W 43rd St New York NY 10036
212 974-4600

Camera lenses, video & cine; tripods & accessories;
production & post-production equip rentals;
post-production services (audio, video, film) VS

FERNSEH INC

PO Box 15068 Salt Lake City UT 84115
801 972-8000

Audio dist & monitor amps, power supplies;
one-inch automated VCRs; TV cameras (color
studio, mono, ENG/EFP); color correctors; color
encoders; digital video noise reducer; full electronic
graphics systems; multiplexers & complete telecine
systems; image enhancers; color monitors; video
proc amps; video pulse, dist & subcarrier amps;
routing switchers; sync generator systems (sync,
color bar, black burst); video action recorders (slow
mo, variable speed, time lapse); video effects
synthesizers, repositioners, compressors; video
source identification systems; two-VTR
editor/controllers; multi-source editors;
computerized auto assembly editors; one-inch
segmented helical VTRs; hum bucking coils VS
See ad pgs 44-45, 119

CA Anthony J. Magliocco 6300 Arizona Cir
Los Angeles 90045 213 641-1636
IL Dave Spindle 720 Landwehr Rd
North Brook 60062 312 291-1150
NJ John D. Webb 279 Midland Ave
Saddle Brook 07662 201 797-7400
OK Mike Richardson 1532 Valley View Dr
Claremore 74017 918 341-9066
VA Alan Schoenberg 7921 Jones Branch Dr Suite 275
McLean 22102 703 790-5570

FIDELIPAC CORP

109 Gaither Dr Mt Laurel NJ 08057
609 235-3511

Audio carts & test tapes; empty reels, carts,
cassettes; tape cleaners; alignment gauges; cart
equip test system; splicing blocks & tape; bulk
erasers; cart storage; video bulk erasers & cleaning
fluid; lamps; wow & flutter meters VS
See ad pg 109

FILMLINE CORP

43 Erna St Milford CT 06463
203 878-2433

Film processors

IMERO FIORENTINO ASSOC INC

10 W 66 St New York NY 10023
212 787-7050

TV studio design; set design; also provides a wide
range of facility & production services VS

FISHER BERKELEY CORP

5800 Christie Ave Emeryville CA 94608
415 655-9696

Intercom systems; PA amplifiers, power supplies

FISHER-BURKE

PO Box 2468 Phoenix AZ 85003
602 257-0225

Complete line of audio products

FIXTURE ELECTRONICS INC

1 W 30 St New York NY 10001
212 695-4767

One-station crystal-controlled FM receivers; SCA
receivers; EBS receivers

FLASH TECHNOLOGY CORP OF AMERICA

55 Lake St Nashua NH 03060
603 883-6500

Strobe beacons for towers VS

JOHN FLUKE MFG CO

PO Box 43210 Mountlake Terrace WA 98043
206 774-2481

Digital frequency counters; microwave counters &
generators; RF sources & digital multimeters; dB
meters; data loggers; IEEE bus systems; digital
printers; computer/microprocessor automation
controllers; automated test & measurement
systems; RF generators; tape loggers & log printers;
voltmeters VS

FOR-A CORP OF AMERICA

1680 N Vine St Los Angeles CA 90028
213 467-8412

Color correctors; titlers; full electronic graphics
systems; SMPTE time code readers & generators VS

FORGFLO CORP BRUSH MAGNETIC HEADS DIV

Third & Regan St Sunbury PA 17801
717 286-5611

Magnetic recorder heads

FORT WORTH TOWER CO INC

PO Box 8597 Fort Worth TX 76112
817 457-3060

Towers, prefab bldgs, earth stations

FREELAND PRODUCTS CO

3233 Conti St New Orleans LA 70119
504 822-9222

Rebuilt vacuum tubes VS

FREQUENCY DEVICES INC

25 Locust St Haverhill MA 08130
617 374-0761

Audio amplifier power supplies, active equalizers &
filters; tone generators; noise reduction systems;
audio generators

FREZZOLINI ELECTRONICS

7 Valley St Hawthorne NJ 07506
201 427-1160

16 mm cine cameras, tripods & accessories;
magnetic recording equipment & accessories;
battery supplies for production equip; battery
chargers VS

See ad pg 132 — refer to rep/dist section

"Feature post-production demands creativity. We've found the Convergence ECS-103 to be the best tool for creative videotape editing."

Real People Editors

For Real People post-production, George Schlatter Productions uses Convergence ECS-103's to edit 3/4" off-line, making edit decision lists to auto-conform, and on-line for mastering. When he began production of his new Speak Up America® series, he ordered two more of our editing systems, this time on 1". Why Convergence?

Convergence Corporation began with the concept of human engineering. We designed a system that is easy and comfortable to use, where you edit pictures and sounds, without having to master computer technology. That same system has to offer accuracy, quality and sophistication.

The Convergence ECS-103 System meets those demands. The new ECS-103C Auto-Conforming Editing System features auto-assembly from disc or tape, and off-line editing capability which is industry standard compatible. The ECS-103C is also the easiest auto-conforming editor to operate and makes list management just as simple.

Call or write Convergence today for a hands-on demonstration, and find out for yourself how comfortable and easy editing can be. *And creative: Real People know.*

CONVERGENCE CORPORATION

1641 McGaw, Irvine, CA 92714 (714) 549-3146
1 Lochaline St., London, W6, England 01-741-7211

Editing means Convergence

Edit like Real People® do- Creatively.

Real People and Speak Up America are registered trademarks of George Schlatter Productions

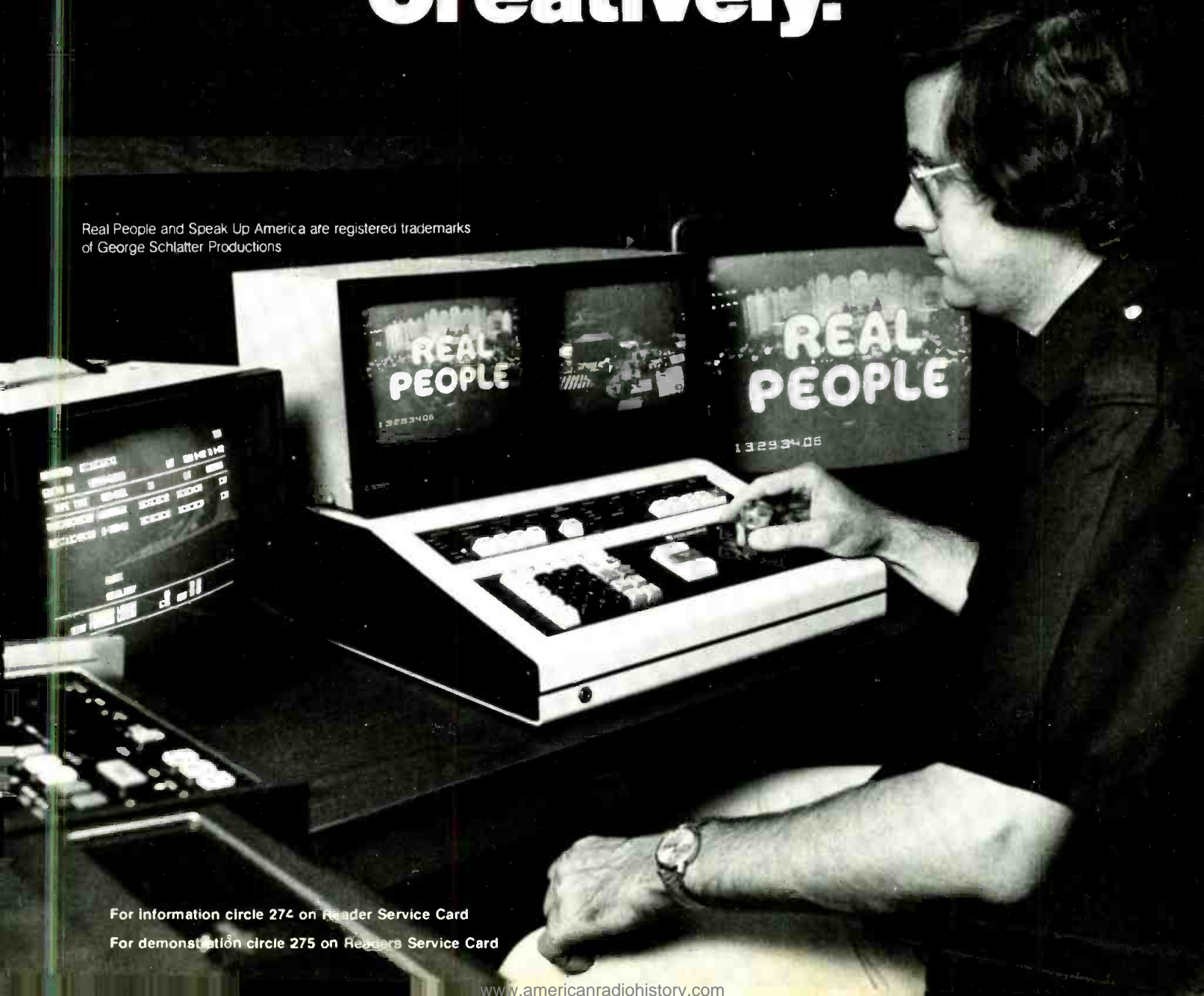

For information circle 274 on Reader Service Card

For demonstration circle 275 on Readers Service Card

from news



to features

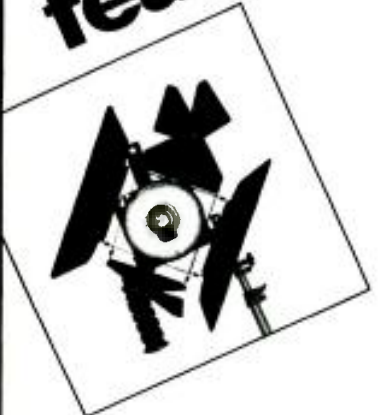

in nothing flat!



lowel
omni
light.

Lowel-Light Mfg. Inc.
421 W 54th St N.Y. N.Y. 10019
(212) 245 6744 Telex 666597UW
West Coast 3407 W Olive Ave
Burbank, Ca 91505
(213) 846-7740



Circle 151 on Reader Service Card

The Source '80

FUJI PHOTO FILM MAGNETIC TAPE DIV

350 Fifth Ave 68 floor New York NY 10001
212 736-3335

Audio tape (open-reel, carts, cassettes); VTR head cleaners; videotape & cassettes VS

See ad pg 87

CA	S.P. Henderson 1211 E. Artesia Bl Carson.....	213 639-8556
GA	Jerry Lester 6534-H Hillendale Dr Norcross 30092.....	404 448-2418
IL	John Walsh 1000 Pratt Bl Elk Grove 60007.....	312 569-3500
KS	Dick Corrigan 10227 Oakmont Cir Lenexa 66215.....	913 492-9077
NH	Peter Arsenaault 6 Siver Dr Nashua.....	603 888-4302
TX	Stan Risetler 3500 Gardenbrook Dr Dallas 75234.....	214 243-2537

FUJINON OPTICAL

672 White Plains Rd Scarsdale NY 10583
914 472-9800

Television and film camera lenses and accessories VS

See ad pg 181 — refer to rep/dist section

FUNG ENGINEERING CO

PO Box 1082 San Carlos CA 94070
415 592-8434

RF demodulators and modulators

G

GABRIEL ELECTRONICS INC

PO Box 626 Scarborough ME 04074
207 883-5161

ENG microwave equip.; waveguide STLs; receive-only satellite earth stations; microwave and communications antennas; transmission line & connectors; tower hardware & construction equipment; facility turnkey installation VS

GARNER INDUSTRIES

4200 N 48 St Lincoln NE 68504
402 489-9100

Tape duplication systems; conveyor-type tape erasers; bulk erasers VS

GARDINER COMMUNICATIONS CORP

1980 S Post Oak Rd Ste 2040 Houston TX 77056
713 961-7348

Receive-only satellite earth stations; RF amps & switchers VS

GAW CO INC

53 S Jefferson Rd Whippany NJ 07981
201 887-7210

Frequency monitors and counters, audio generators, voltmeters, harmonic distortion meters, EBS two tone systems

GBC CLOSED CIRCUIT TV CORP

315 Hudson St New York NY 10013
212 989-4433

TV cameras, studio & portable (b&w & color); camera mounts; telecine chains; monitors; sync gens; spec effect gens; coaxial connectors; video distribution amps, pulse distribution amps

GC ELECTRONICS

400 S Wyman St Rockford Il 61101
815 968-9661

Headphones; mics (dynamic, condenser/electret, lavalier); mic stands, booms & dollies; speakers; empty audio tape reels, carts & cassettes; tape cleaners; splicing blocks & tape; head degaussers & bulk erasers; VU meters; VTR head cleaners; replacement VTR & VCR drive belts & wheels; towers; tower hardware & construction equip; digital clocks; voltmeters & multimeters; audio & electrical connectors; wire & cable

GENERAL CAMERA CORP

471 11 Ave New York NY 10018
212 594-8700

Cine cameras; camera accessories; film magnetic recording equip

GENERAL ELECTRIC CO LIGHTING BUSINESS GROUP

Nela Park Cleveland OH 44112

216 266-2092

Stage, studio, TV lamps VS

GENERAL ELECTRIC CO VIDEO DISPLAY EQUIP OPERATION

Electronics Pk 6-206 Syracuse NY 13221

315 456-2152

Large screen video projectors VS

See ad pg 40

GENERAL TELEVISION NETWORK

13225 Capital Ave Oak Park MI 48237
313 548-2500

Production & post-production equip rentals; facility turnkey installation; mobile van construction; audio & video post-production services; stage rental; TV studio design; videotape/film recording transfer VS

GLASSMAN HIGH VOLTAGE INC

PO Box 551 Whitehouse Sta NJ 08889
201 534-2226

DC power supplies, power displays, TV, flying spot scanners

GLOBAL COMM & ENGINEERING

914 White Plains Rd Trumbull CT 06611

203 261-2068

Facility turnkey installation; radio and TV design VS

See ad pg 126

GLOBAL SPECIALTIES CORP

70 Fulton Terr New Haven CT 06509
203 623-3103

Frequency monitors & counters; RF generators; waveform monitors & analyzers VS

GLOBE UNION INC BATTERY DIV

5757 N Green Bay Ave Milwaukee WI 53201
414 228-2581

Batteries, battery chargers

GOLDMARK COMMUNICATIONS CORP

98 Commerce Rd Stamford CT 06904
203 327-7270

Film to video transfer systems; tape duplication

ALAN GORDON ENTERPRISES INC

1430 N Cahuenga Blvd Hollywood CA 90028
213 466-3561

Dist of full line cine production equip; tripods (FOBA); RF mics (Swintek); director's viewfinder; animation motors (NCE); grip equip; film projectors VS

See ad pg 198

GORMAN-REDLICH

6 Curtis St Athens OH 45701
614 593-3150

Antenna monitors, phase meters, EBS two-tone systems; DA equipment; radio weather radar systems; receivers, comm, & monitor; weather info service VS

See ad pg 175

GOTHAM AUDIO CORP

741 Washington St New York NY 10014
212 741-7411

AM & FM compressor/limiters; parametric equalizers & filters; mechanical reverb & audio special effects; turntables; phono cartridges; complete disc consoles; mics (condenser/electret, shotgun, lavalier); mic stands, booms & dollies; noise reduction systems; speakers; tape timers; splicing blocks & tape; VU, PPM & LED audio level indicators; wow & flutter meters; transformers VS

GOULD INC IND BATTERY DIV

2050 Cabot Blvd W Langhorne PA 19047
215 752-0555

Batteries, battery chargers; emergency power supplies for production equip VS

GRALEX INDUSTRIES DIV

155 Marine St Farmingdale NY 11735
516 694-3600

Digital voltmeters; line monitors

GRANDY INC

1275 Bloomfield Ave Fairfield NJ 07006
201 575-1433

Replacement & rebuilt audio tape heads VS



Ikegami Chooses
Anton/Bauer Batteries



Thomson Chooses
Anton/Bauer Batteries



Hitachi Chooses
Anton/Bauer Batteries



Panasonic Chooses
Anton/Bauer Batteries



Philips Chooses
Anton/Bauer Batteries



JVC Chooses
Anton/Bauer Batteries



Sharp Chooses
Anton/Bauer Batteries

**THE
INDUSTRY
STANDARD**

anton
bauer
BATTERIES

**CHOSEN BY MORE PROFESSIONAL
VIDEO MANUFACTURERS
THAN THE COMPETITION COMBINED**

Anton/Bauer batteries are chosen as standard equipment by more video camera manufacturers than the competition combined! That should come as no surprise. Considering the amount of time and money manufacturers invest in the design and performance of their camera, they will not tolerate any battery but the best.

Professional video equipment manufacturers and users can't help but be impressed by Anton/Bauer features such as rugged injection molded LEXAN cases; silver plated contacts; sleek, quick-change modular design (the original snap-on camera concept); the variety of fast and slow charges; plus the exclusive A/B Computerized Testing Center for maximum quality control, snap-on mounts for almost all cameras and VTR's, as well as belt holders and the Perpetual Power Belt.

Innovation, superior technology, craftsmanship and time-tested dependability make Anton/Bauer the choice of video manufacturers, television networks, over 1,000 video installations and countless independent users. Be in great company. Choose Anton/Bauer batteries.



Anton/Bauer Inc.

66 Center Street, Shelton, CT. 06484 (203) 735-3305

Circle 152 on Reader Service Card

More than
400 RADIO
& TV
broadcast towers
have been guyed
with Phillystran®

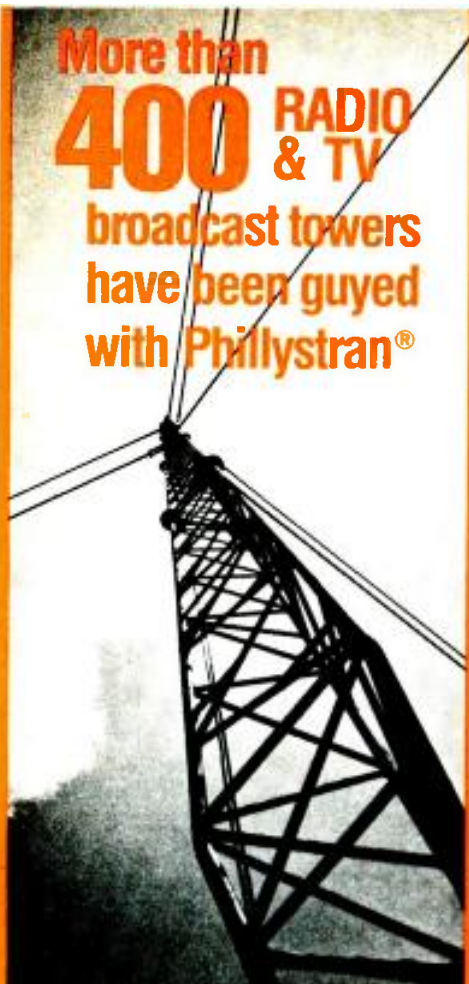

Phillystran® HPTG installed on WORL in Orlando.

Phillystran®:
the only field-proven,
flexible dielectric
guying system

- 1 simplifies installation of AM directionals, CP antennas and other broadcast towers.
- 2 eliminates EMI and RFI.
- 3 combines high strength with light weight and inherent flexibility.
- 4 improves antenna stability for AM directionals
- 5 maintenance-free: non-conducting, non-corroding, nonmetallic. No insulators required. No white-noise arcing problems!

Plus...

**High Performance
Phillystran® HPTG**

with IMPROVED STRESS-ELONGATION PROPERTIES for "tension-once and walk-away" installations.

Call/write for new literature and proven solutions to your tower-guy problems.

PHILADELPHIA RESINS CORP.



20 Commerce Drive
Montgomeryville, PA 18936
(215) 855-8450
Telex 84-6342

Circle 153 on Reader Service Card

The Source '80

THE GRAPHIC EXPRESS
7969 Engineer Rd Suite 201 San Diego CA 92111
714 565-2146
TV studio design VS

GRASIS CORPORATION
PO Box 1039 Kansas City MO 64141
816 483-1100
Towers; tower lighting VS

THE GRASS VALLEY GROUP INC
PO Box 1114 Grass Valley CA 95945
916 273-8421
Digital audio multiplexer; RGB & encoded chroma keyers; manual & automated master control switchers; video proc amps; large & small production switchers; video amps (pulse, dist, subcarrier, isophasing & equalizing, delay, fiber optic); routing switchers; signal equalizing systems; video special effects gens; sync generator systems (sync, black burst, single-line); frame syncs; digital video effects; colorizers; repositioners; compressors; video generators VS

See ad pgs 7,106
CA Suite 206 21243 Ventura Blvd
Woodland Hills 91364 213 999-2303
GA Suite 102 1644 Tuttle Cir NE
Atlanta 30329 404 321-4318
IN 810 West Bristol St
Eikhart 46514 219 264-0931
MN Suite 238 3585 North Lexington Ave
Arden Hills 55112 612 483-2594
NY Station Plaza East
Great Neck 11021 212 229-4049
TX 316 Seminary Office Bldg
Fort Worth 76115 817 921-9411

GRAY ENGINEERING LABS
504 W Chapman Ave Suite 0 Orange CA 92668
714 997-4151
SMPTC time code equip; video source identification systems VS
See ad pg 180 — refer to rep/dist section

VS MEANS IT'S VERIFIED

THE GREAT AMERICAN MARKET
PO Box 178 Woodland Hills CA 91364
213 883-8182
Lighting heads, stands, fixtures, light projected patterns, special effects, fresnels, control systems VS

GREGG LABORATORIES
2120 E Howell #505 Anaheim CA 92806
714 937-1100
AM & FM compressor/limiters; audio preamps; ALC & AGC amps VS

GRINNAN FIXTURE CO
16041 Georgetown St NE Minerva OH 44657
216 862-2323
Studio cabinets & furniture; complete studio construction; open reel & cartridge tape storage; racks & cabinets; finance services; mobile van construction; facility turnkey installation; building & remodeling plans VS

GROTON COMPUTER INC
19 Fort Hill Rd Groton CT 06340
203 445-2325
Radio & TV computer business services/equipment VS

GRUBER PRODUCTS CO
5254 Jackman Rd Toledo OH 43613
419 476-7200
Mobile ENG carts, projection tables VS

GRUBER RECORDING & SERVICE CO
214 N Chestnut St Palmyra PA 17078
717 838-6973
Open-reel audio tape & cassettes; empty reels, carts & cassettes; tape rewinders; audio tape duplicators; two-way radio communications; tape loggers; mobile van construction; syndicated radio programming services; rebuilding broadcast studio equip

GTE LENKURT INC
1105 Country Rd San Carlos CA 94070
415 595-3000
Intercity microwave equip; RF program subcarrier; receivers, comm & monitor; microwave & telco STLs; satellite earth stations (transmit/receive, receive-only) VS

GTE PRODUCTS CORP SYLVANIA IND/COMM LIGHTING
Sylvania Lighting Center Danvers MA 01923
617 777-1900
Lamps VS

GYR PRODUCTS/GDETICS INC
1335 So Claudina St Anaheim CA 92805
714 772-1000
Time lapse VTR

H

HALLIKAINEN & FRIENDS
101 Suburban Road San Luis Obispo CA 93401
805 541-0200
Auto loggers; auto time/weather announcers; audio consoles for TV; remote control systems; automatic transmitter control logging VS
See ad pg 140—refer to rep/dist section

HAMMOND INDUSTRIES
155 Michael Dr Syosset NY 11791
516 364-1900
Stereo disco mixers (Meteor); power amps (Meteor); speakers (Meteor), speaker overload protectors (Meteor); sound-to-light controllers, lighting units, light projectors (Meteor); equalizers, (Klark-Teknik); audio test unit; audio response analyzer (Ferroglyph); equipment racks and shelving (Click Systems)

HARRIS CORP BROADCAST PRODUCTS DIV
PO Box 4290 Quincy Il 62301
217 222-8200
Audio preamps, line amps, monitor & power supplies; ALC & AGC amps; FM compressor/limiter/filters; complete automation systems; audio consoles (portable, mono & stereo multi-output studio, audio for TV); turntables; phono arms & cartridges; headphones; RF intercoms; mics (dynamic, condenser/electret, lavaliere); mic stands, booms & dollies; noise reduction systems; patch panels; speakers; SMPTE time code synchronizing systems; audio open-reel tape, cassettes & test tapes; empty reels, carts & cassettes; leader tape; tape alignment gauges; single & dual audio cart player/recorders; portable open-reel player/recorders; splicing blocks & tape; head degaussers & bulk erasers; cart storage; color studio cameras; camera heads, tripods, pedestals & dollies; video camera lenses, adapters & extenders; camera power packs; color correctors; image enhancers; video proc amps; production switchers, large & portable; video pulse amps; remote pan & tilt systems; sync generator systems (sync, color bar); digital sync decoder; frame syncs; teleprompters; TBCs (helical capstan servo, helical non-servo capstan); video film noise reducers; video test charts & slides; multi-source video editors; computerized auto assembly editors; 16 mm cine cameras; slide projectors; magnetic recording equip & accessories; dimmer packs; demodulators; diplexers; AM stereo & FM exciters; microwave equip (intercity, portable, ENG); microwave supports & portable equip; RF phasing network; RF cables; FM processors; RF connectors; modulators; remote control systems; remote pickup equip; RF amps & attenuators; microwave & optical fiber STLs; satellite earth stations (transmit/receive, receive-only); translators; AM, FM, VHF & UHF transmitters; FM & microwave antennas; HP & CP TV antennas; transmission line & connectors; towers; tower hardware & construction equip; tower lighting; antenna monitors; automated test & measurement systems; digital clocks; master & slave clocks; timers; diff phase-gain measurement; AM, FM & TV field intensity meters; audio generators; RF generators; multiple-output video generators; log printers; modulation monitors; oscilloscopes; phase meters; RF wattmeters;

HOW TO GAIN CONTROL.

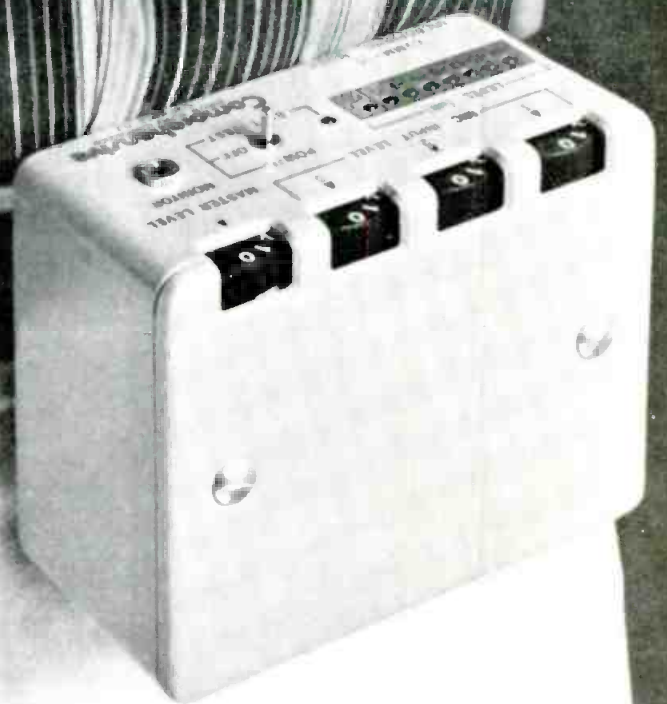

Whatever you're shooting, you want to make sure you call the shots. So, naturally, when it comes to sound, you need something to keep it all under your thumb. And we've got it. The CVMM-15 professional broadcast mixer you slip on your belt and take with you, anywhere.

With this little audio mixer, there's no question of control. Three XLR microphone inputs, each with independent gain control. Master output level control. Built-in 9V phantom supply. Balanced output with selectable level for either microphone or line. Peak-reading LED meter. Monitor output. 80 dB gain. And more.

All in a compact, rugged unit that not only stays out of your way, but is virtually indestructible. Made with the finest, latest state of the art technology, it's designed and manufactured for us by Foundation Instruments, so you know it's the very best.

You want total control? Get our tough little CVMM-15.

It's not afraid to mix with the best of them.

For more information contact your Comprehensive dealer or call us TOLL FREE at 800-526-0242. In N.J. and Metro N.Y. call 201-767-7990. Telex: 13-5139.

Comprehensive

VIDEO SUPPLY CORPORATION

148 Veterans Drive, Northvale, N.J. 07647

In Canada: 751 Wain Street, Winnipeg, Man. R3G 2T6

Circle 154 on Reader Service Card

THE BONNEVILLE DA's

- Bridging (20k) Inputs
- Transformers In & Out
- Up to 30 dB of gain
- + 24 dBm Outputs
- Over 80 dB s/n at + 4 dBm Out

THE DA-6

1x6 expandable to 1x10



- General-purpose audio DA
- Continuous-short-circuit protection
- 600 or 150 ohm systems
- 60 dB isolation over 20-20 kHz
- Less than .5% THD, 30-20K, + 24 dBm
- Self-contained power supply

THE DA-10

Media Coverage/
Convention DA



- XLR Connectors—in and out
- Six line outputs plus four mic/line-selectable outputs
- Perfect for last-minute feeds of press conferences
- Other features as DA-6 above

THE PC-1

Press Corps
Distribution Amplifier



- Transformer Isolation
- Line Input
- 16 Line/Microphone Outputs
- Backup power supply
- XLR Connectors—in and out

OTHER MODELS
AVAILABLE



BONNEVILLE PRODUCTIONS
A DIVISION OF
BONNEVILLE INTERNATIONAL CORPORATION

130 SOCIAL HALL AVENUE
SALT LAKE CITY, UTAH 84111
(801) 237-2400
TELEX/TWX 910-925-5266

Circle 155 on Reader Service Card

The Source '80

spectrum analyzers; status & alarm indicators; vectorscopes; video noise meters; voltmeters; waveform monitors & analyzers; EBS two-tone systems; facility turnkey installation; mobile van construction; radio & TV studio design; battery chargers; 19-inch equip racks; cabinets & furniture; storage shelves; quartz crystals; transformers; vacuum tubes **VS**

See ad pg 12 — refer to rep/dist section

CA	5839 Green Valley Cir Ste 200 Culver City 90230.....	213 642-0052
DC	2600 Virginia Ave, NW 8th fl 20037.....	202 342-3946
NY	675 3rd Ave New York 10017.....	212 986-7600
TX	7000 Regency Square Blvd Ste 200 Houston 77036.....	713 977-2411
CAN	19 Lesmill Rd Don Mills, Ont M3B 2T3.....	416 441-2400
	212 Brunswick Blvd Pointe-Claire Quebec H9R 1A6.....	514 694-3371

HARRIS CORP SATELLITE COMM DIV
ANTENNA OPERATIONS
2600 N Longview St Kilgore TX 75662
214 984-0555

Satellite earth stations (transmit/receive,
receive-only, mobile) **VS**

HARRIS CORP SATELLITE COMMUNICATIONS
DIV

PO Box 1700 Melbourne FL 32901
305 724-3000

Satellite earth stations (transmit/receive,
receive-only) **VS**

HARRIS VIDEO SYSTEMS

1255 E Argus Ave Sunnyvale CA 94086
408 737-2100

Electronic still stores; frame & field syncs; TBCs
(helical capstan servo, helical non-servo capstan,
quad); video compressors; two-VTR
editor/controllers; multi-source video editors;
computerized auto assembly editors; digital video
effects; video repositioners **VS**

See ad pg 32

HARRISON SYSTEMS

Box 22964 Nashville TN 37202
615 834-1184

Audio consoles (portable, stereo studio
multi-output, automated); LED and 10 level
indicators **VS**

HARWOOD MFG CO

1800 W Fullerton Chicago IL 60614
312 929-1100

Photographic & electronic lighting equip, portable
lighting bars

HEATH CO

Benton Harbor MI 49022
616 982-3200

Audio preamps, monitor & power supplies; stereo
multi-output studio consoles; speakers; LED audio
level indicators; video projectors; frequency
monitors & counters; harmonic distortion meters; IM
meters; oscilloscopes; vectorscopes; voltmeters;
multimeters; dB meters; small computers; digital
weather computer; battery chargers **VS**

HEDCO

PO Box 1985 Grass Valley CA 95945
916 273-9524

Audio line & dist amps; audio & video routing
switchers; video pulse, dist & subcarrier amps; 75
ohm terminations; return loss bridges; electrical
terminations **VS**

KARL HEITZ INC

979 3 Ave New York NY 10022
212 421-5220

Mic stands, booms & dollies; camera heads, tripods
& dollies; lens adapters; 16 mm cine cameras; cine
camera lenses; cine camera tripods & accessories;
motion picture film projectors; lighting heads, stands
& fixtures **VS**

HEWLETT-PACKARD CO
PO Box 301 Loveland CO 80537
303 667-5000

Automated test & measurement systems; diff
phase-gain measurement; frequency monitors and
counters; audio and RF generators; impedance
bridges; logic analyzers; modulation monitors;
oscilloscopes; phase meters; sideband analyzers;
spectrum analyzers; voltmeters; multimeters; dB
meters; TV and computer equipment **VS**

HICKOK INSTRUMENT CO

10514 DuPont Ave Cleveland OH 44108
216 541-8060

Frequency monitors & counters; RF & audio
generators; impedance bridges; voltmeters,
multimeters; RF wattmeters; oscilloscopes; video
test generators for servicing

HIGH-LITE CORP

23 Selwyn Dr Greenville SC 29615
803 268-7702

Towers; emergency power equipment; mobile van
construction

HITACHI DENSHI AMERICA LTD

175 Crossways Park West Woodbury NY 11797
516 921-7200

Studio & portable color & mono video cameras;
video monitors; one-inch Type C VTRs; ENG
microwave equip; oscilloscopes; waveform
monitors and analyzers; camera pickup tubes **VS**
See ad pgs 4-5

CA	21015 S Figueroa St Carson 90745.....	213 328-2110
CO	3538 Peoria Bldg 3 Ste 505 Aurora 80010.....	303 344-3156
GA	3610 Clearview Pkwy Doraville 30340.....	404 451-9453
IL	1725 N 33 Ave Melrose Pk 60160.....	312 344-4020
MD	4720 P Boston Way Lanham 20801.....	301 459-8262
OH	11250 Cornell Pk Dr Cincinnati 45252.....	513 489-6500
TX	14169 Proton Rd Dallas 75240.....	214 233-7623
WA	1051 Andover Pk W Tukwila 98188.....	206 575-1680

HM ELECTRONICS INC

6151 Fairmont Ave San Diego CA 92120
714 280-6050

Wireless mic systems; audio mixers **VS**

HOLLAND ELECTRONICS INC

970 E 92 St Brooklyn NY 11236
212 649-7330

Audio amps (line, monitor, power); preamps;
op-amp modules; consoles (mixers, quad, audio for
TV); headphones; intercom systems

HOUSTON FEARLESS 76 INC

833 E Walnut St Carson CA 90746
213 770-4715

8, 16, 35 mm film processors, pollution control &
silver recovery systems

HOUSTON PHOTO PRODUCTS INC

655 E 20th St Yuma AZ 85364
602 782-3677

Film processors

HOWE AUDIO PRODUCTIONS INC

Box 383 Boulder CO 80306
303 494-4693

Mixing consoles

HSC INC

2932 River Rd PO Box 155 River Grove IL 60171
312 452-5551

19-inch equip racks; cabinets & furniture **VS**

HUGHES ELECTRONIC DEVICES CO — see
Hedco

HUGHES MICROWAVE COMM PRODUCTS

3060 W. Lomita Blvd Torrance CA 90509
213 534-2146

Intercity microwave equip; satellite earth stations
VS

HUGHEY & PHILLIPS INC

3050 N California St Burbank CA 91505
213 849-1104

Tower lighting, beacons, de-icers

HY-GAIN ELECTRONICS — See Telex Comm



**When you upgrade,
start with Auditronics
new 110B on-air
console**

The 110B on-air mixer gives you up to 18-inputs in either stereo or mono with these standard features

- Control room monitor
- Headphone control
- Seven mono line output amps
- Three stereo bridging line amps
- Five VU meters
- Stereo program and audition output channels with meters
- Mono output with meter
- Cue on all mic and line inputs.

Auditronics modular design lets you start now with a basic main-frame and add modules for greater operational flexibility later when you need them. And, all Auditronics input modules and faders are interchangeable and obsolescence-proof. If you'd like to air a signal that is truly state-of-the-art, the place to start is with an Auditronics 110B console. For complete information and the name of your nearest dealer, circle reader service number or call us.



auditronics, inc.

3750 Old Gerwell Road, Memphis, Tennessee 38118 (901) 362-1350

Circle 156 on Reader Service Card

www.americanradiohistory.com



THIS is the Disc
that plays in the memory
that Knox built.



THIS is the Program
that cues the pages
that store on the disc
that plays in the memory
that Knox built.

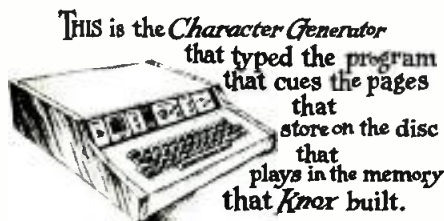

THIS is the System
that goes with the character generator
that typed the program
that cues the pages
that store on the disc
that plays in the memory
that Knox built.

Create and store up to 400 pages of character generator type on a single five-inch floppy disc.

Using the same keyboard, program the playback and store it — the program — on the same disc with your typed copy.

Call or write today for a demo to see what the Knox memory system can do for your screen.



A DIVISION OF COMPUTER OPERATIONS, INC

5001 — J Forbes Boulevard, Lanham, MD 20801

301/459-2106 Telex 89-8327

The Source '80

I

IDEAL INDUSTRIES

1780 Becker Pl Sycamore IL 60178
815 895-5181

Wire, cable stripping equip

IGM COMMUNICATIONS

4041 Home Rd Bellingham WA 98225
206 733-4567

Time insertion sequencers;

computer/microprocessor automation controllers;
complete automation systems; auto time/weather
announcers; single & multiple audio cart
player/recorders; computer business services for
radio VS

IKEGAMI ELECTRONICS (USA) INC

37 Brook Ave Maywood NJ 07607
201 368-9171

Full line TV color studio, portable ENG/EFP/EC
cameras; color correctors; color encoders; image
enhancers; monochrome, color & dc portable
picture monitors; small & portable prod switchers;
special effects generators; sync generator systems;
videotape/film recording transfer VS

See ad pgs 15,143 — refer to rep/dist section

CA	19164 Van Ness Ave Torrance 90501	213 328-2814
GA	522 S Lee St Americus 31709	912 924-0061
TX	330 N Bell E Ste 228 Houston 77060	713 445-0100

IMAGE DEVICES INC

1825 NE 149 St Miami FL 33181
305 945-1111

Portable audio mixer; headsets, headphones,
intercom systems; lavalier condenser mic; tripods;
ENG camera braces; color portable picture monitor;
carrying cases; magnetic recording equip &
accessories; production equip rental; TV studio
design; underwater housing for cine camera, other
cine camera accessories VS

IMAGE MAGNIFICATION INC

739 Airway Cir New Smyrna Beach FL 32069
904 427-5294

Large screen TV projection systems

IMAGE RESOURCE

2260 Townsgate Road Westlake Village CA
91361

805 496-3317

TV mono cameras; portable ENG/EFP/EC
cameras; optical printer; automatic TV monitors; TV
business computer services/equipment; video to
hardcopy systems VS

IMAGE TRANSFORM INC

4142 Lankershim Blvd N Hollywood CA 91602
213 985-7566

Videotape film transfers, scene by scene video
correction, standards conversions VS

IMAGE VIDEO LTD

700 Progress Ave Unit 16
Scarborough ONT M1H 2Z7
416 438-3940

Audio monitor & power supplies amps; automation
controllers, computer/microprocessor; complete
automation systems; patch panels; RGB, encoded
& luminance chroma keyers; manual, automated, &
business auto interface master control switchers;
small production switchers; video dist. amps;
routing switchers; digital clocks; timers; status &
alarm indicators; TV business computer
services/equip. VS

INDUSTRIAL ELECTRIC REELS INC

10102 F St Omaha NE 68127
402 339-9300

Cable reels & collector rings

INDUSTRIAL RESEARCH PRODUCTS INC

321 N Boro St Elk Grove Vill II 60007
312 439-3600

Audio delay systems; mic mixers; noise reduction
systems VS

INDUSTRIAL SCIENCES INC

PO Box 1495 Gainville FL 32602
904 373-6783/800 874-7590

Audio for TV consoles; audio dist amps; RGB &
encoded chroma keyers; manual & automated
master control switchers; video pulse, dist,
subcarrier & processing amps; large, small &
automated production switchers; routing switchers;
sync, color bar & black burst generator systems;
video automated telecine light control; DA equip VS
See ad pg 83 — refer to rep/dist section

INFORMATION PROCESSING SYSTEMS OF CALIFORNIA INC

70 Glenn Way Suite 2 Belmont CA 94002
415 592-1742

TV weather radar systems; weather info service VS

INNOVATIVE TELEVISION EQUIP (ITE)

Box 681 Woodland Hills CA 91365
213 888-9421

Camera heads, tripods, dollies, ENG braces,
pedestals; microwave supports & portable equip VS

INOVONICS INC

503-B Vandell Way Campbell CA 95008
408 374-8300

ALC & AGC amps; AM compressor/limiters; FM
compressor/limiter/filters; noise reduction systems;
replacement audio recorder electronics; reel
tension servo kit; spectrum analyzers VS
See ad pg 124 — refer to rep/dist section

INSTRUMENT LABORATORIES CORP

350 N Eric Dr Palatine IL 62067
312 358-4622

Test equip; cable locators; fault finders

INTEGRATED SOUND SYSTEMS GLI DIV

29-50 Northern Blvd LIC NY 11101
212 729-8400

Graphic equalizers & filters; multi-output stereo
studio consoles; speakers VS

VS MEANS IT'S VERIFIED

INTERAND CORP

666 North Lake Shore Drive Chicago IL 60611
312 943-1200

Electronic video graphic systems; full line video
effect devices; scan converters (from X-Y or Y-T to
video) VS

INTERFACE VIDEO SYSTEMS

1333 New Hampshire Ave NW Wash DC 20036

Videotape/film recording, transfer; one inch type C
videotape/16 mm film production; one inch type C
computer managed videotape editing

INTERNATIONAL AUDIO INC

2934 Malmo Dr Arlington Heights IL 60005
312 956-6030

Audio cassette tape duplicators; new audio
cassettes; tension and alignment gauges; new
3/4-inch videotape VS

INTERNATIONAL ELECTRO-MAGNETICS

350 N Eric Dr Palatine IL 60067
312 358-4622

Graphic equalizers & filters; replacement & rebuilt
audio tape heads; audio equalizers and filters;
replacement tape heads VS

INTERNATIONAL INSTRUMENTS DIV SIGMA INSTRUMENT INC

88 Marsh Hill Road Orange CT 06477
203 795-4711

Analog, VU & peak indicators, voltmeters, dB
meters

INTERNATIONAL MICROWAVE CORP

33 River Road Cos Cob CT 06807
203 661-6277

Microwave equip; STL & remote pickup, intercity,
portable, ENG VS

Circle 157 on Reader Service Card

THE NEW 900 SERIES MODULAR SIGNAL PROCESSING SYSTEM. IT'S COMPACT. IT'S FLEXIBLE. IT'S dbx.

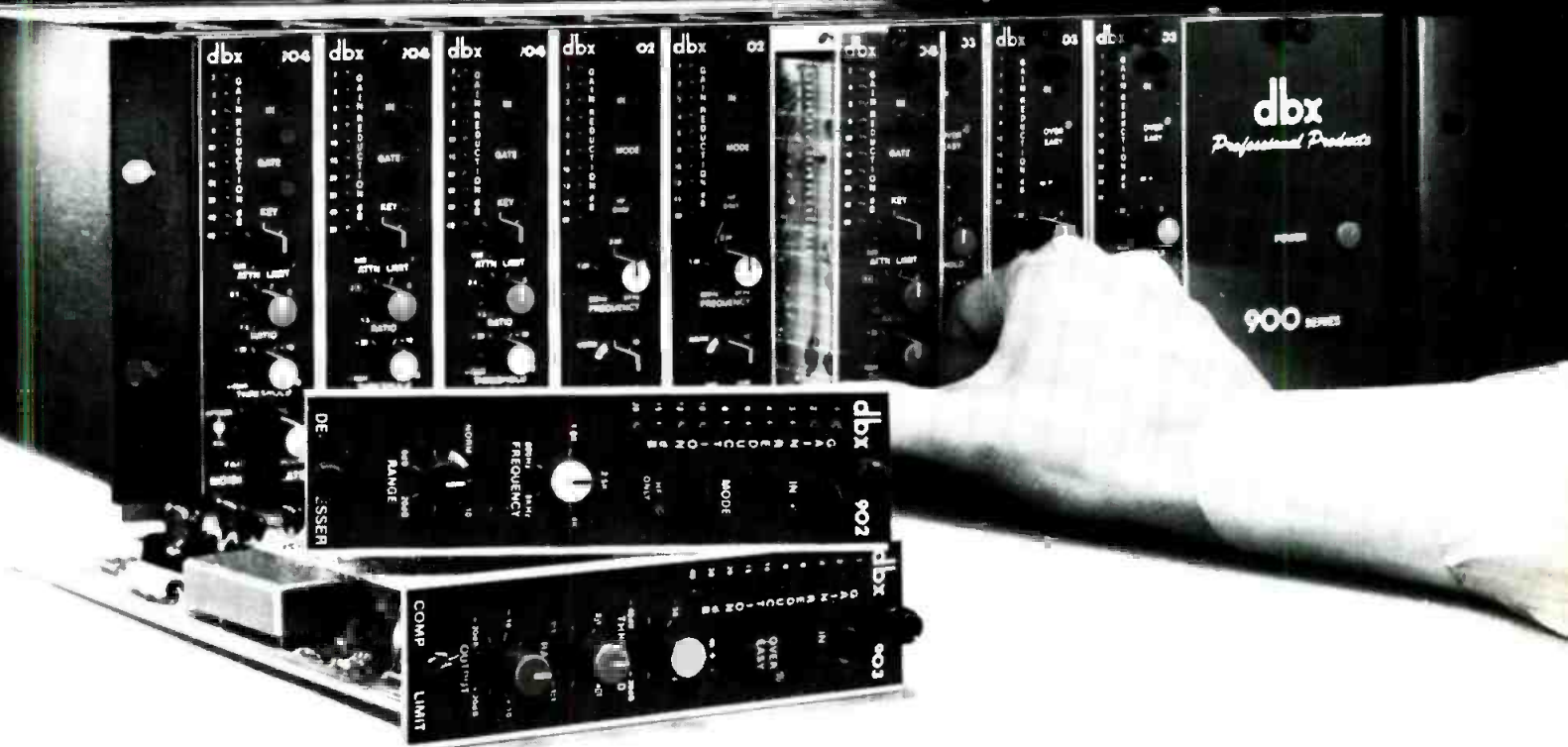

With rack space at a premium, you want to save space anywhere you can. That's why dbx is introducing the new 900 Series Modular Signal Processing System.

You start with a single, easy-to-install 5¼" x 19" rack with built-in power supply. Then just slip in the modules you need. Up to 8 dbx signal processors, with storage for a ninth.

But the modules themselves are the real stars.

Our Model 902 is the only de-esser that continuously analyzes the input signal spectrum, providing the exact amount of de-essing you want regardless of signal level. And the 902 can be used broadband or on high frequencies only.

The 903 Compressor offers a special negative compression feature. In use, it actually begins to attenuate at the threshold, which gives the signal a new sense of punch. Of course the 903 also features our Over Easy compression as well as true RMS level detection.

Our 904 Noise Gate features adjustable attack and release rates, Over Easy downward expansion, a special key input that allows you to gate one instrument by another, and a unique "gate" mode which eliminates the need to gain ride solos during multi-track mixdown.

The 900 frame accommodates dbx noise reduction modules as well.

And this is just the beginning of our signal-processing system. Soon we'll be offering an equalizer, a flanger, and more.

So now you've got a signal processing system that's everything you want.

It's compact. It's flexible. Best of all, it's dbx.

dbx, Incorporated, 71 Chapel St., Newton, MA 02195. 617/964-3210.

FACT!

No one can match The Complete Lightning Protection Systems from LEA.

- ANTENNA DISSIPATION ARRAYS TO PREVENT LIGHTNING STRIKES
- GUY CHARGE DISSIPATION CHOKES
- SURGE ELIMINATORS* FOR MAIN POWER LINES OF SERIES HYBRID DESIGN TO HANDLE REPEATEDLY ENERGY LEVELS OF > 5500 JOULES PER PHASE
- * THOUSANDS IN USE REFERENCES AVAILABLE
- KLEANLINE ELECTRONIC FILTERING SYSTEMS TO PROTECT AGAINST LIGHTNING STRIKES AT > 5500 JOULES PER PHASE PLUS AN RFI/EMI FILTER TO HANDLE RF INTERFERENCE FOR SENSITIVE SOLID STATE EQUIPMENT.
- TRANSIENT ELIMINATORS FOR DATA LINES, PHONE LINES, COMMUNICATIONS EQUIPMENT WITH A FREQUENCY RESPONSE FROM D.C. TO 1 GIGAHERTZ.
- LIGHTNING WARNING SYSTEMS PROVIDING 1/2 HOUR ADVANCE WARNING OF AN APPROACHING STORM.
- SURGE AND TRANSIENT GENERATORS
- GROUND SYSTEMS
- CONSULTING SERVICES

Lightning Elimination Associates



12516 Lakeland Road
Santa Fe Springs, CA 90670
(213) 944-0916

Circle 159 on Reader Service Card

The Source '80

INTERNATIONAL NUCLEAR CORP 608 Norris Ave Nashville TN 37204 615 254-3365

Audio amps (distribution, line, preamps, monitor); tone generators; consoles (mixer, mono, audio for TV, portable); RGB chroma keyers; video amps (pulse, distribution, subcarrier); production switchers (large & small); master control switchers, post prod. & routing switchers; SEGs; signal equalizing systems; digital video effects & colorizers; equalizers, presence detectors; hum bucking coils; EBS two-tone systems

INTERNATIONAL RECTIFIER CORP 233 Kansas St El Segundo CA 90245 213 322-4987

High power cartridge rectifier columns; solid state tube replacements; rectifiers, surge protectors

INTERNATIONAL TAPETRONICS CORP

PO Box 241 Bloomington IL 61701
309 828-1381

Audio cart player/recorders (single, dual, multiple, time delay); portable open-reel tape player/recorders VS

See ad pg 103

INTERNATIONAL VIDEO CORPORATION (IVC) 455 W Maude Ave Sunnyvale CA 94086 408 738-3900

Color studio cameras; studio/field convertible cameras; ENG, EFP cameras; remote control mounts; helical & segmented-helical VTRs VS

IONIC INDUSTRIES INC 128 James St Morristown NJ 07960 201 539-1040

Music synthesizers, sound effects

ISI—See Industrial Sciences Inc

ITI ELECTRONICS INC PO Box 260—369 Lexington Ave Clifton NJ 07011 201 546-3900

Audio preamps, line, monitor & power amps; amp power supplies; rotary attenuators; ALC & AGC amps VS

ITT JENNINGS 970 McLaughlin Ave San Jose CA 95122 408 292-4025

Coaxial switchers, variable vacuum capacitors; RF voltmeters; vacuum relays, coaxial relays & switchers; RF switchers VS

ITT SUPRENT 172 Sterling St Clinton MA 01510 617 365-6331

Coaxial cables, instrumentation cable, high temperature wire, control cable

IVIE ELECTRONICS INC 500 W 1200 S, Orem UT 84057 801 224-1800

Audio amps (preamps, power, public address); active equalizers and filters; frequency monitors & counters; audio gens; voltmeters, dB meters; harmonic distortion meters VS

J

J&D ELECTRONICS DIV J&D INTERNATIONAL Unit E-East, Interstate Ind Pk Bellmawr NJ 08031 609 931-4100

Monitor, distribution amps; chroma keyers, processing amps, pulse & distribution amps, video production switchers, black burst generators, special effects generators, colorizer, equalizer; post-production switchers; routing switchers; emergency power equip

JAMES B. LANSING SOUND (JBL) — See Lansing

JAMIESON FILM COMPANY 6901 Forest Park Rd Dallas TX 75235 800 527-2298

Color film processors; film processor accessories VS

JAMPRO ANTENNA CO — See Cetec Antennas

THE JANSON INDUSTRIES Box 1200 Garfield Ave SW Canton OH 44706 216 455-7029

Lamps; dimmer packs; gels & filters/special effects; patch terminals; plugs & connectors; seamless materials VS

JATEX INC 2626 Freewood Dallas TX 75220 214 358-0200

SMPTE time code generators, reader generators; color bar, black burst sync generator systems; two-VTR editor controllers

JAVELIN ELECTRONICS INC 19831 Magellan Dr Torrance CA 90502 213 327-7440

TV mono cameras; camera lenses & extenders; monochrome picture monitors; video dist. amps; remote pan & tilt systems; time lapse video action recorders; video source ID systems; modulators VS

JBL—See Lansing

JEFFERSON DATA SYSTEMS Executive Plaza 501 Archdale Dr Charlotte NC 28210

704 374-3631
Business data systems for radio & TV VS

JENEL CORP 9550 Forest Ln Dallas TX 75243 214 343-1229

Facility turnkey installation; mobile van construction; radio & TV studio design VS

JENSEN TRANSFORMERS 10735 Burbank Blvd N Hollywood CA 91601 213 876-0059

Transformers VS

JOHANSON MFG CO Rockaway Valley Rd Boonton NJ 07005 201 334-2676

Variable capacitors

JOHNSON ELECTRONICS INC 62 South Hwy 17-92 Casselberry FL 32707 305 339-2111

FM SCA tuners, receivers; audio amps; data transmission input terminals; peripheral equip

JVC INDUSTRIES—See US JVC Corp

K

K&H PRODUCTS LTD PO Box 246 N Bennington VT 05257 802 442-9118

ENG camera mounting braces, dollies, ENG equip carts, shipping cases

KAHN COMMUNICATIONS INC 839 Stewart Ave Garden City NY 11530 516 222-2221

Passive equalizers and filters; telephone coupling equip; AM stereo equip; audio processors

KAITRONICS CORP 1540 Gilbreth Rd Burlingame CA 94010 415 697-9102

SMPTE time code readers, generators, reader/generators; tape evaluators; alphanumeric generators; tape loggers; machine control systems; titlers; two-VTR editor/controllers VS

KALAMUSIC 600 ISB Bldg Kalamazoo MI 49007 616 385-5110

Syndicated radio programming services VS

KALART VICTOR CORP Hultenius St Plainville CT 06062 203 747-1663

TV image enhancer; film editing equip, image enhancers; flatbed film editors; film splicing equip; motion picture projectors; magnetic recording film VS

A NOT-SO-BASIC SYNCHRONIZER/TBC AT A VERY BASIC PRICE.

The Quantel DFS 1550.

It costs less than any other digital synchronizer on the market. Yet has features that make it unique in its class.

Of course it can synchronize any non-synchronous video signal. It also does a superb job of time base correcting, from phased or non-phased sources. With exclusive automatic non-phased detection.

And it has many other features, including an infinite window of correction, remote TBC capability, wrong-field edit correction, look-ahead velocity compensator, sync generator, 3.58 MHz feedback, and an analyzer for detecting faulty store cards.

In short, everything you need for digital synchronizing and time base correcting. And more than you can get from any other digital synchronizer or TBC at anywhere near the price.

If you are thinking about buying time base correctors, shouldn't you get synchronizing and TBC capability? The cost will be about the same — but the Quantel DFS 1550 will give you vastly greater performance.

Call your nearest MCI/Quantel representative for more details. Or get in touch with us directly: Micro Consultants, Inc., P.O. Box 50810, Palo Alto, California 94303, 415/856-6226.

MCI/QUANTEL
The digital video people

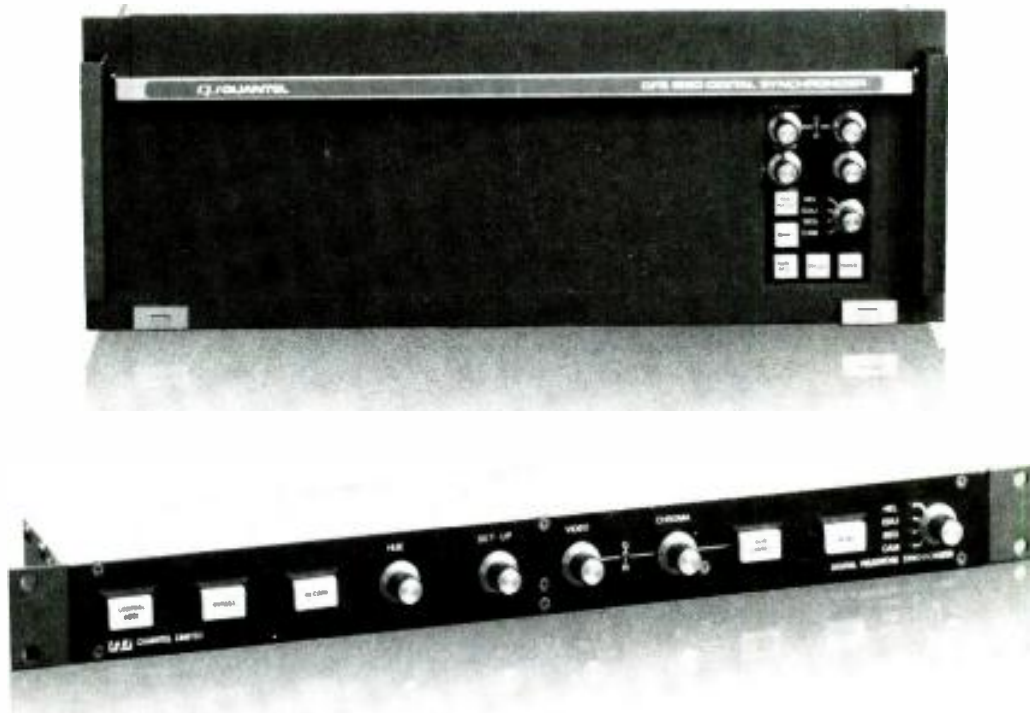

Circle 160 on Reader Service Card

"MCI/Quantel" is a trademark of Micro Consultants, Inc.

www.americanradiohistory.com

TIRED OF PATCHING FEEDS TO THE GM'S OFFICE?

(OR TO OTHER OFFICES, CLIENT VIEWING ROOMS, EDIT SUITES, ETC.?)

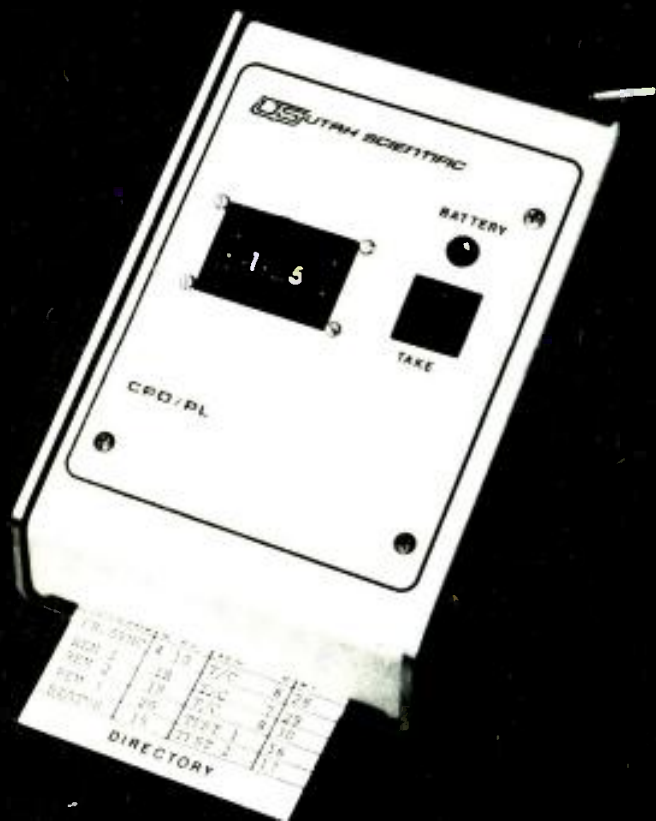

Give them one of these
Utah Scientific Routing
Switcher Controllers
and let them do
their own patching.

Utah Scientific's new CPD/PL control is a Party Line panel with a single coax control connection — no bulky cables to install. It is powered by a transistor radio battery providing many years life expectancy. It features a pull-out directory to aid the operator in source selection.

Since multiple CPD/PL's can all be connected to a single party line, many stations are installing coax drops throughout their plants giving them complete flexibility for present and future routing switcher control using these versatile panels.

SINGLE COAX CONNECTION — BATTERY POWERED — UNOBTRUSIVE

TRY THAT ON YOUR GRASCOMFERNSAM DYNATEK SWITCHER!

US **UTAH SCIENTIFIC**
THE ROUTING SWITCHER PEOPLE.

2276 So. 2700 W. • Salt Lake City, UT 84119 • Phone 801-973-6840
TWX #910-925-4037

Circle 161 on Reader Service Card

The Source '80

KALLMAN ASSOCIATES INC
2525 Hyperion Ave Los Angeles CA 90027
213 660-4900
Character/graphics and alphanumeric generator systems, monitor calibrators

KAMAN SCIENCES CORP/BCS
1500 Garden of the Gods Rd PO Box 7463
Colorado Springs CO 80933
303 599-1601
Radio and TV computer business services
newsroom computers. financial services VS

KANDTT PRODUCTS
Box 246 N Bennington VT 05257
802 442-9118
ENG camera braces & dollies; carry and shipping cases

KAPPA NETWORKS INC
165 Roosevelt Ave Carteret NJ 07008
201 541-1600
Audio & video delay lines; video filters

KAY ELEMETRICS CORP
12 Maple Ave Pine Brook NJ 07058
201 227-2000
Audio spectrum analyzers; rotary attenuators, slide attenuators; RF generators; programmable attenuators; bench & OEM attenuators; pulse generators; toggle switches

KAY INDUSTRIES INC
604 N Hill St South Bend IN 46617
219 234-0171
Rotary phase converters (single phase to three phase)

KB SYSTEMS
10407 62 P1 W Everett WA 98204
206 355-8740
Magnetic recording equip & accessories; vertical film editors VS

KILOVAC CORP
PO Box 4422 Santa Barbara CA 93103
805 684-4560
RF switchers VS

KINETRONICS CORP
42 Sherwood Terr Lake Bluff IL 60044
312 295-5600
Film cleaners VS

KINGS ELECTRONICS
40 Marbledale Rd Tuckahoe NY 10707
914 793-5000
Video patch panels; RF connectors VS

KITCHEN PRODUCTIONS
619 W Ridgecrest Blvd Ridgecrest CA 93555
714 375-2753
FM & TV translators

KLIEGL BROS INC
32-32 48 Ave Long Island City NY 11101
212 786-7474
Lighting hardware, heads, stands and fixtures; automated and manual controls; patch terminals, plugs & connectors; lighting kits VS

KLINE IRON & STEEL CO INC
PO Box 1013 Columbia SC 29202
803 779-7080
Towers, tower hardware & construction equip

KNOX VIDEO PRODUCTS
5001J Forbes Blvd Lanham MD 20801
301 459-2106
Graphic art character generators VS
See ad pg 98 — refer to rep/dist section

KODAK—See Eastman Kodak Co

KOLLMORGEN CORP PHOTO RESEARCH DIV
3000 N Hollywood Way Burbank CA 91505
213 843-6100
Exposure meters; color temperature meters; spot brightness meters; screen brightness meters

KORTICK MFG CO
5600 Third St San Francisco CA 94124
415 822-6660
Pole line hardware

KOSS CORP
4129 N Washington St Milwaukee WI 53212
414 964-5000
Headphones, dynamic & electrostatic; speakers

KREONITE INC
715 E 10 St PO Box 2099 Wichita KA 67201
316 263-1111
Film lab and graphics studio design; film processors; studio cabinets and furniture; lighting stands and fixtures

VS MEANS IT'S VERIFIED

L

LAIRD TELEMEDIA INC
2424 S 2570 W Salt Lake City UT 84119
801 972-5900
Character generators; teletext multiplex equip; slide projectors; automatic teletext light control VS
See ad pg 173 — refer to rep/dist section

LAMPKIN LABS INC
PO Drawer 9048 Bradenton FL 33506
813 792-5566
Demodulators; frequency monitors & counters; audio & RF generators VS

it Quality at \$990.

THE PD II RECORDER plays mono tapes in "A" size cartridges. Stops automatically on 1kHz cue. Big and small buy it for the same reason: nothing else does this task so well, so long, so reliably, with so little maintenance. Also available in Reproducer Only for **\$725.**

CALL TOLL-FREE
800-447-0414

Ask about our no-risk, 30-day trial order. Call collect from Illinois, Alaska, Hawaii: (309) 828-1381. Standard 2-year warranty.

INTERNATIONAL TAPETRONICS CORPORATION
2425 South Main Street, Bloomington, Illinois 61701

Marketed exclusively in Canada by McCurdy Radio Industries, Ltd., Toronto



Circle 162 on Reader Service Card

The Source '80

LANDY ASSOCIATES INC

1890 E Marlton Pike Cherry Hill NJ 08003
609 424-4660

Rental service; distributor of full line of audio and video production equipment; equipment racks

JAMES B. LANSING SOUND INC (JBL)

8500 Balboa Blvd Northridge CA 91329
213 893-8411

Audio amps (line, preamps, monitor, power, public address); speakers; audio monitors; electronic crossover units; audio compressors **VS**

LAUDERDALE ELECTRONIC LABS

16 SW 13 St Ft Lauderdale FL 33315
305 764-7755

Audio preamps, dist amps, ALC & AGC amps; graphic equalizers & filters; splicing blocks & tape; bulk erasers; cart storage; automated lighting control systems; digital clocks; timers; tower lighting **VS**

LEAR SIEGLER INC BOGEN DIV

Box 500 Paramus NJ 07652
201 343-5700

Audio preamps, line amps, monitor amps, power amps, dist amps; amp power supplies; ALC & AGC amps; AM & FM compressor/limiter/filters; graphic equalizers & filters; hardwired intercoms **VS**

LEASAMETRIC

1164 Triton Drive Foster City CA 94404
415 574-4441

Telecommunications test equip rentals **VS**

LEE-RAY INDUSTRIES INC

38 E 1 Ave Mesa AZ 85202
602 962-6806

Video equipment carriers **VS**

LE CROY RESEARCH SYSTEMS

10024 York Rd Cockeysville MD 21030
301 628-2240

Fiber optic video transmitters/receivers; optical fibers

LECTROTECH INC

5810 N Western Ave Chicago IL 60659
312 769-6262

Color picture monitors; oscilloscopes; vectorscopes; frequency monitors and counters **VS**

LEGAL TAPES INC

22530 West Eight Mile Road Southfield MI 48034
313 353-3355

Post production service; video tape/film recording transfer

LEITCH VIDEO LTD

705 Progress Ave Scarborough Ontario M1H 2X1
416 438-5060

Video proc amps; video pulse, dist, subcarrier, clamp amps; sync generator systems (sync, color bar, black burst, stairstep/ramp, multiburst); video equalizers; video source identification systems; digital clocks; master & slave clocks; time distribution systems; multiple-output video generators; phase meters **VS**

LEMO USA INC

PO Box 6626 Santa Rosa CA 95406
707 523-0600

Audio, radio & electrical connectors **VS**

See ad pg 175

LENCO INC ELECTRONICS DIV

300 N Maryland St Jackson MO 63755
314 243-3147

Color encoders, processing amps; pulse distribution amps; sync generators; black burst generators; video presence detector; video noise meters, test generators; b&w & color picture monitors; delay amps; routing switchers; signal equalizing systems; video delay lines; comb encoders; video equalizers **VS**

See ad pg 133 — refer to rep/dist section

CA	5456 Blossom Acres Dr San Jose 95124	408 356-0221
GA	Box 4042 Albany 31706	912 436-4927
KS	1120 S 4 St Atchison 66002	913 367-1146
MD	7303 Poplar Ln Middletown 21769	301 371-5588
TX	13620 Littlecrest Dr Dallas 75234	

LENZAR OPTICS CORP

1006 W 15 St Riviera Bch FL 33403
305 844-0263

Camera lenses **VS**

LEXICON INC

60 Turner St Waltham MA 02154
617 891-6790

Audio digital delay system; variable speed tape recorder; speech compressor/expanders; digital reverberation systems; audio time compressors

LIGHTNING ELIMINATION ASSOC

12516 Lakeland Rd Santa Fe Springs CA 90670
213 944-0916

Surge protectors; electronic filtering systems; dissipation arrays; surge & transient eliminators **VS**

See ad pg 100 — refer to rep/dist section

LINES AUDIO/VIDEO SYSTEMS

Jefferson at McDaniel Springfield MO 65806
417 862-5533

Small video switcher/fader

STROBEGUARD®

HIGH INTENSITY
OBSTRUCTION
LIGHTING SYSTEMS*
FOR TELEVISION AND
RADIO TOWERS AND
SIMILAR SKELETAL
STRUCTURES.



TECHNICAL PRODUCTS GROUP — BEDFORD DIVISION
35 CONGRESS ST., SALEM, MASSACHUSETTS 01970
TEL: (617) 745-3200
ATTENTION: GEORGE MANDEVILLE, PRODUCT MANAGER

*FAA APPROVED as meeting or exceeding the requirements of Advisory Circular AC 150/5345-43 and FAA/DoD Specifications L-856 plus FAA AC 70/7460-1E.

Circle 163 on Reader Service Card

STARTING OCT. 1

A NEW STRENGTH IN RADIO BROADCASTING EQUIPMENT

BROAD PRODUCT LINES OF AM AND FM TRANSMITTERS

Starting October first, Continental Electronics will offer broadcasters a complete line of high quality AM and FM radio transmitters, stereo studio consoles, antenna systems and related equipment.

The transmitter product line will include AM and FM transmitters 1 kW thru 50 kW.

This expansion is brought about in part by Continental's recent purchase of Collins Broadcast Products Group from Rockwell International Corporation.

NEW FACILITIES

New manufacturing facilities have been completed at Continental's plant in Dallas, to handle the additional product lines.

MARKETING AND FIELD ENGINEERING

Continental broadcast equipment, and existing Collins radio transmitters, will be serviced by a world-wide Continental field support and marketing group headquartered in Dallas.

This group has been expanded to meet customer requirements in a professional manner.

PIONEER AND LEADER IN HIGH-POWER RF SYSTEMS

Since its founding in 1946, Continental Electronics has pioneered many advances in high-power rf transmitter and systems technology at power levels from kilowatts to megawatts; for communications, radio broadcast, radar and scientific research applications.

Continental medium wave and short wave broadcast transmitters have achieved a world-wide reputation for quality components and construction; circuit innovations and unique, simple-to-operate designs which produce superior performance.

STRENGTH YOU CAN DEPEND ON

Whatever your radio broadcast needs may be, Continental offers quality equipment and competent marketing and engineering support.

For information on Continental broadcast equipment, call (214) 381-7161 or contact Broadcast Marketing Department, Continental Electronics Mfg. Co., P. O. Box 270879, Dallas, Texas 75227
Telex: 73-398

See us at the NRBA, booth 405 & 406.

Continental Electronics



Circle 164 on Reader Service Card

The Source '80

LIPSNER-SMITH CORP
4700 Chase Lincolnwood IL 60646
312 675-8473
Ultrasonic film cleaning machines

VS

LISTEC TELEVISION EQUIPMENT CORP
39 Cain Dr Plainview NY 11803
516 694-8963

Audio consoles (portable; mono & stereo studio multi-output, audio for TV); PPM meters; full line camera support equip; video camera lenses, adapters & extenders; teleprompters; video delay lines; compressors

VS

See add pg 186

CA Howard Stucker 4529 San Fernando Rd
Unit A Glendale 91204..... 213 247-9247

LIVE SOUND INC
1741 N Ivar St Suite 101 Hollywood CA 90028
213 462-3351
Syndicated radio programming services

VS

LOGITEK ELECTRONIC SYSTEMS INC
3320 Bering Dr Houston TX 77057
713 782-4592

Delay systems; audio consoles (mono & stereo studio multi-output, audio for TV); VU, PPM, LED audio level indicators; timers; EBS two-tone systems; game show electronics systems

VS

LONG ENGINEERING CO
961 Burke St Winston Salem NC 27101
919 725-2306

Multi-media; radio & TV studio design, facility turnkey installation; custom mixers and consoles

(Deltronix); amp modules, transformers (Deitronix); intercom systems (Deltronix)

LOWEL-LIGHT MANUFACTURING INC
421 W 54 St New York NY 10019
212 245-6744

Lighting heads, stands & fixtures; portable lighting kits; diffusion material; gels & filters

VS

See ad pg 92

CA Lowel-Light West 3407 W Olive Ave
Burbank 91505..... 213 245-6744

LPB INC

28 Bacton Hill Rd Frazer PA 19355
215 644-1123

Audio preamps, dist amps; AM & FM compressor/limiter/filters; audio consoles (one-output mic mixers, mono & stereo studio multi-output, audio for TV); full line disc playing equip; FM exciters; RF carrier current; RF amps; AM & FM transmitters

VS

See ad pg 170 — refer to rep/dist section

CA Richard W. Burden 20944 Sherman Way
Canoga Park 91303..... 213 340-4590

LTM CORP OF AMERICA

1160 N Las Palmas Ave Hollywood CA 90038
213 460-6166

Lighting heads, stands & fixtures, gels & filters, special effects, plugs & connectors; portable audio console; portable open-reel tape recorders

VS

L-W INTERNATIONAL

6416 Varlet Ave Woodland Hills CA 91367
213 348-8614

16 mm telecine projectors; motion picture projectors; flickerless film projectors; 16 mm film chain projectors

VS

M

3M CO MAGNETIC AUDIO/VIDEO PRODUCTS DIV

3M Center Bldg 223-5N St Paul MN 55101
612 733-1662

Full line of audio & video recording tape; magnetic film; accessories

VS

See ad pg 64

3M MINCOM DIV/DATA PRODUCTS

3M Center Bldg 223-5E St Paul MN 55144
612 736-1032

Computer/microprocessor automation controllers; digital audio recorders; titlers & full electronic graphics systems; image enhancers; small production switchers; video pulse, dist & subcarrier amps; routing switchers; color bar sync generator systems; helical capstan servo TBCs; one-inch helical VTRs

VS

3M MINCOM DIV/VIDEO PRODUCTS

3M Center Bldg 223-5C St. Paul MN 55144
612 733-0803

Computer/microprocessor automation controllers; RGB chroma keyers; titlers & full electronic graphics systems; image enhancers; video proc amps; production switchers (small & portable); routing switchers; special effects gens; sync & color bar sync generator systems; helical capstan servo TBCs; digital video effects; colorizers; one-inch helical VTRs

VS

See ad pg 56, 117 — refer to rep/dist section

MACH ONE — See Fernseh

MACKENZIE LABS INC

5507 Peck Road Arcadia CA 91006
213 579-0440

Single, dual, multiple tape, continuous loop cartridge player/recorders; film projectors (motion pic, slide); automatic light dimmer control

VS

MAGNASYNC/MOVIOLA CORP

5539 Riverton Ave N Hollywood CA 91603
213 763-8441

Film editing equip; magnetic film recorders & accessories; telephone coupling equip; complete film telecine systems; film inspection equip; videola film-to-video transfer system

VS

Today's GVG 3400 Series is the
Most complete line of
quality video DAs available.

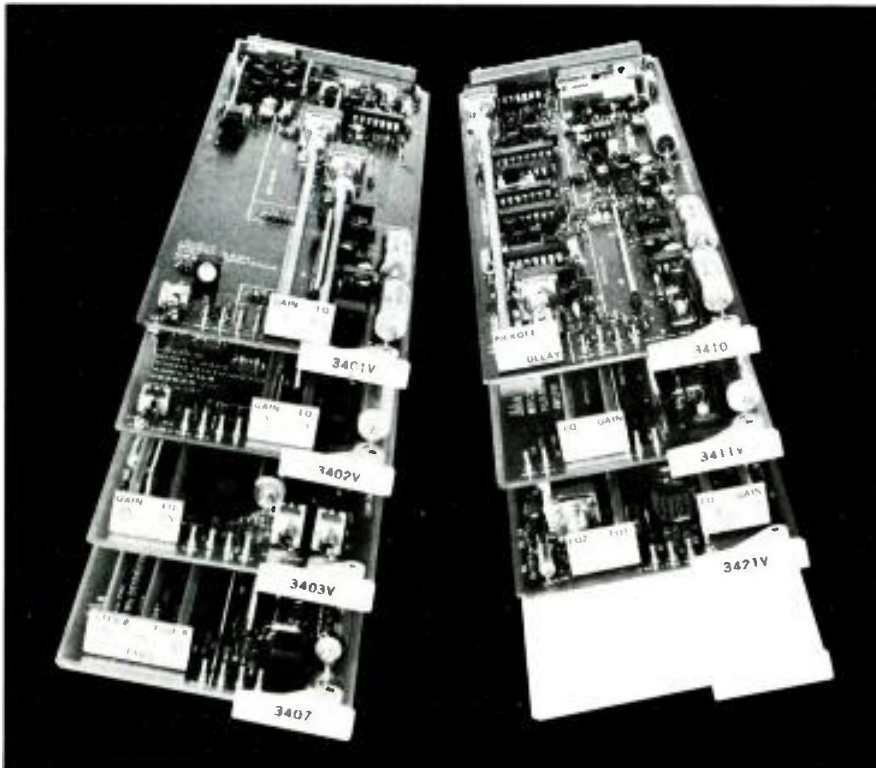

The 3400 Series line is comprised of distribution amplifiers of these types: ★ General purpose ★ Precision
★ Clamping ★ Subcarrier ★ Regenerative pulse
★ Linear pulse ★ Long cable equalizing, and a
★ *New video delay DA, coming soon!*

3400 Series high performance DAs are performance-proven, extremely reliable, and competitively priced.

THE GRASS VALLEY GROUP, INC.®

PO BOX 1114 GRASS VALLEY CALIFORNIA 95945 USA

Circle 165 on Reader Service Card

QUANTAFONT™

Teleproduction Graphic Titlers

The unique microcomputer technology that enables self-contained, high performance titling at affordable costs.



Q-7A

- Proportional characters and spacing with
- NANOLOG 20 nsec resolution*
- 16 resident fonts from 8 to 64 raster lines high
- Colorized characters and backgrounds
- Full border and shadow edge selections
- Extensive composition and editing functions
- 10, 16-row page resident memory with memory protect battery
- Roll, crawl and flash with 2-speed control
- And more



Q-VII

- 3 resident fonts with 20 selectable display sizes of all fonts
- NANOLOG 20 nsec resolution*
- Colorized characters and backgrounds
- Full border and shadow edge selections
- 12, 16-row page resident memory with memory protect battery
- Extensive composition and editing functions
- Roll, crawl and flash with 2-speed control
- And more



Q-VI

- 24 character sizes selectable by row
- Upper and lower case font of capital letters
- Character resolution up to 32 horizontal pixels
- Color backgrounds and graphic separators
- Extensive composition and editing functions
- 12, 16-row page resident memory with memory protect battery
- Roll, crawl and flash with 2-speed control
- And more
- Monochrome only (Q-VI/A)



Q-V

- 12 character sizes selectable by row
- Upper and lower case font of capital letters
- Character resolution up to 32 horizontal pixels
- 12, 16-row page resident memory
- Random access to 48 resident positionable titles
- Vertical title positioning at any raster location
- Roll, crawl and flash
- Mini-cassette extended memory — optional
- And more



Flexible Disc Memory Accessories

- Single or dual mini-disc storage systems
- 100, 16-row pages per disc
- Random or sequential page access of less than .5 seconds
- Data block of titler resident memory per disc
- Memory console can accommodate 6-inch monitor



Digital Cassette Memory Accessories

- High speed computer grade cassette tape systems
- Block load storage of entire resident memory
- **Top mounting** console with or without 6-inch monitor
- **Self standing** style coordinated tape transport only

QST Sub Titling System

Incorporates all of the Q-7A composing and display capabilities for self-contained, automatic sub-titling. Interfaces directly to audio or TTL level EBU/SMPTE time code.

- Full function titler for entry of translated text
- Automatic disc indexing
- Flexible title editing
- Off-air edit and control display

Q-VI/M Automatic Mass Memory Display

- Programmable control over a digital cassette mass memory
- Over 3,000 rows — 400 pages, typical
- All display capabilities of Q-VI titler available for automatic recall

International Alphabets

- Accented international alphabets available for all titling systems



Mini-Cassette Digital Tape Transport

- **On board** mini-cassette digital tape extended memory — Q-V only
- Block load storage of resident memory on each side of mini-cassette

SYSTEM CONCEPTS
To Be Letter Perfect

System Concepts, Inc.
395 Ironwood Drive
Salt Lake City, Utah 84115
Phone: (801) 486-3833
TWX: 910-925-5684

Eastern Corporate Office and
System Concepts International
16006 Waterloo Road
Cleveland, Ohio 44110
Phone: (216) 692-3410
TWX: 810-421-8192

*Effective average start-point resolution with patent pending NANOLOG™ circuit.

Circle 166 on Reader Service Card

The Source '80

MAGNA-TECH ELECTRONIC CO INC

630 Ninth Ave New York NY 10036
212 586-7240

Audio mixing consoles; open-reel player/recorders; studio systems; tape head replacement; film projectors (motion picture & flickerless); magnetic recording equip & accessories; video-motion picture interlock equip; vidimag recorders; telecine equip **VS**

See ad pg 174

MAGNECRAFT ELECTRIC CO

5575 N Lynch Chicago IL 60630
313 282-5500

Coaxial and RF switches, relays

MAGNEFAX INTERNATIONAL INC

Rt 1 Box 764 Rogers AR 72756

Tape duplicators; bulk erasers **VS**

MAGNESONICS SALES & MFG CO

3740 E Transport Ventura CA 93003
805 642-3092

Audio tape rewinders; head degaussers; bulk erasers **VS**

MAGNETIC REFERENCE LAB

229 Polaris Ave Suite 4 Mountain View CA 94043

415 965-8187

Test tapes

MARATHON PRODUCTS

334 W Boylston St W Boylston MA 01583
617 853-0988

Tape cartridges; empty reels, carts & cassettes; tape cleaners; torque & speed indicators; head degaussers; splicing blocks; auto loaders

VS MEANS IT'S VERIFIED

MARCONI ELECTRONICS INC

100 Stonehurst Court Northvale NJ 07647
201 767-7250

TV color studio cameras; ENG/EFP cameras; video pulse, dist & subcarrier amps; standards converters; sync generator systems (sync, color bar & black burst); video equalizers; video test charts & slides; video source identification systems; one-inch helical VTRs; TV combiners; modulators; RF amps; AM, FM, VHF & UHF transmitters; antenna monitors; automated test & measurement systems; automatic TV monitors; diff phase-gain measurement; audio generators; RF generators; video generators (multiple output & cross pulse); impedance bridges; IM meters; modulation monitors; spectrum analyzers; video noise meters & test generators; VITS, VIR systems & equip; wow & flutter meters **VS**

See ad pg 79

MARCONI INSTRUMENTS DIV

100 Stonehurst Ct Northvale NJ 07647
201 767-7250

Modulation monitors; TV sideband analyzers; spectrum analyzers; video test generators; automatic TV monitors; digital synchronizers; noise test sets; sweep generators; other TV test gear; frequency counters; audio & RF signal generators; distortion meters; timing interval measurement; VITS analyzer **VS**

See ad pg 120 — refer to rep/dist section

MARKETRON

2180 Sand Hill Rd Menlo Park CA 94025
415 854-5301

Business computer services for radio and TV

MARTI ELECTRONICS INC

1501 N Main PO Box 661 Cleburne TX 76031
817 645-9163

Audio line, monitor & power amps; ALC & AGC amps; AM & FM compressor/limiters; dynamic mics; intercity & ENG microwave; remote control systems; FM SCA equip; microwave STLs; TV

exciters; film; remote pickup equip; TV SCA equip **VS**

MASTER BROADCAST SERVICES INC

6 E Trenton Ave POB 61 Morrisville PA 19067
215 736-0211

Syndicated radio programming services **VS**

MATRIX SYSTEMS INC

PO Box 31386 Dallas TX 75231
214 826-8331

Radio business computer services/equip **VS**

MATSUSHITA — See Panasonic

MATTHEWS STUDIO EQUIP INC

2405 Empire Ave Burbank CA 91504
213 843-6715

Camera dollies & support equip; lighting stands, heads & fixtures; diffusion material; cine camera tripods & accessories **VS**

MATTHEY PRINTED PRODUCTS LTD — See

Television Equipment Associates

MAXELL CORPORATION OF AMERICA

60 Oxford Dr Moonachie NJ 07074
201 440-8020

Audio & video tape

McCURDY RADIO

1711 Carmen Dr Elk Grove Village IL 60007
312 640-7077

Audio line, monitor, power & dist amps; amp power supplies; AM compressor/limiters; parametric equalizers & filters; audio consoles (mic mixers, mono & stereo studio multi-output, audio for TV); turntables; hardwired intercoms; audio patch panels; low frequency extenders; PPM meters; digital clocks; master & slave clocks; audio post-production services; radio & TV studio design **VS**

See ad cover 3

NJ 223 W Saddle River Rd Saddle

River 07458 201 327-0750

NY 1051 Clinton St Buffalo

14206 716 854-6700 (Toronto)

Time Code on the Move

The New PTC-100 sets the standard for TV and Film EFP Time Code generation and recovery.

Rugged, reliable and compact the PTC-100 Generator • Reader is designed to accommodate the user and meet all your EFP requirements . . . for TV and Film.

Features include:

- Identifies Color Field sequence in Time Code
- Film Standards: 24, 25 and 30fps.
- TV Standards: NTSC, PAL & PAL-M.
- Jam Sync reader: several PTC-100's can be slaved together.
- No multi function controls.
- Power saving circuitry: 5 days normal operation with four AA cells, or plug into external 6-12 VDC source. NiCad batteries and charger are optional.
- Remote control for Time Code.
- Generates and reads User Bits.
- Thumbwheels preset time counter, or loads User Bits into memory.
- Designed-in servicing aids, including Signature Analysis techniques.



skotel

SKOTEL CORPORATION
1445 Provencher, Brossard
Que., Canada J4W 1Z3
Telex 05-267493
(514) 676-1813

See us at SMPTE '80

Circle 167 on Reader Service Card

MCG ELECTRONICS INC
 160 Brook Ave Deer Park NY 11729
 516 586-5125
 Surge protectors VS

McGRAW-EDISON DIV EDISON ELECTRONICS
 Grenier Ind Air Park Manchester NH 03103
 603 669-0940
 RF attenuators

MCI INC
 400 W Commercial Blvd Fort Lauderdale FL
 33309
 405 491-0825
 Audio consoles (mono & stereo studio multi-output,
 automated); open-reel studio tape player/recorders;
 SMPTE time code audio synchronizing systems &
 video reader/generators; SMPTE A/V recorder
 synchronizers VS
 See ad pgs 173, 180

MCI/QUANTEL
 PO Box 50810 Palo Alto CA 94303
 415 856-6226
 Electronic still stores; frame & field synchronizers;
 digital video effects; noise reduction systems;
 special effects generators; standards convertors;
 helical capstan servo, non-servo capstan & quad
 TBCs; video effects repositioners & compressors;
 time base correctors; digital effects systems; image
 enhancers; digital noise reducers/filters VS
 See ad pg 101 — refer to rep/dist section

CA	C Martin PO Box 612 Reseda 91335.....	213 999-5947
	D Prather PO Box 50810 Palo Alto 94303	
CT	D Dever 300 Broad St Ste 500 Stamford 06901.....	203 348-4104
GA	P Fletcher 2971 Flowers Rd Ste 106 Atlanta 30341.....	404 457-1266
KS	R Frillman 6617 Hallett Shawnee Mission 66216.....	913 631-8293

McKAY DYMEK
 PO Box 5000 Claremont CA 91711
 714 621-6711

High fidelity AM receiver; shielded loop antenna;
 audio monitors; all-wave receiving antenna;
 communication receivers; RF preselectors VS

McMARTIN INDUSTRIES INC
 4500 S 76 Omaha NE 68127
 402 331-2000
 Audio preamps, line, monitor & power amps; amp
 power supplies; AM & FM compressor/limiters;
 graphic equalizers and filters; audio consoles (mic
 mixers, portable, mono & stereo studio multi-output,
 audio for TV); turntables; hardwired intercoms; bulk
 erasers; demodulators; FM exciters; intercity &
 ENG microwave; RF program subcarrier & carrier
 current; receivers, comm & monitor; remote pickup
 equip; RF amps; FM & TV SCA equip; microwave
 STLs; AM & FM transmitters; FM antennas; FM
 SCA field intensity meters; modulation monitors;
 EBS two-tone systems VS

MEDIA CONCEPTS INC
 559 49 St S St Petersburg FL 33707
 813 321-2122
 Camera power packs; video & audio
 post-production services; equip, rental, battery
 supplies for production equip; SMPTE time code
 generators; production equip rentals;
 post-production services VS

MEDIA EXPRESSIONS INC
 PO Box 11 St Albans NY 11412
 212 528-8205
 TV production equip, rentals; program concept
 development & TV production consulting services VS

MEMOREX CORP
 PO Box 988 Santa Clara CA 95052
 208 987-1343
 Magnetic tape cartridges & cassettes; tape head
 cleaners; new video tape VS

MERLIN ENGINEERING WORKS INC
 1880 Embarcadero Rd Palo Alto CA 94303
 415 856-0900
 Rebuilt VTR machines; audio monitor & power

amps; tape duplicators; quad TBCs; videotape
 evaluators & rewinders; quad VTRs; VTR machine
 rebuilding VS
 See ad pg 118

MICHIGAN MAGNETICS
 203 W 3 St Vermontville MI 49096
 517 726-0590
 Replacement tape heads

MICMIX AUDIO PRODUCTS INC
 2995 Ladybird Ln Dallas TX 75220
 214 352-3811
 Reverberation units; audio special effects units;
 LED PPM, VU meters VS

MICRO ACOUSTICS CORP
 8 Westchester Plaza Elmsford NY 10523
 914 592-7627
 Pickup cartridges; speakers VS

MICRO COMMUNICATIONS INC
 PO Box 4365 Grenier Field Manchester NH
 03108
 603 624-4351
 RF diplexers, attenuators, filters, loads, switchers;
 TV combiners, RF cables & connectors; antennas
 (FM, HP & CP TV); transmission line & connectors VS

MICRO CONSULTANTS INC (MCI/QUANTEL) —
 see MCI/Quantel

MICRO CONTROL ASSOCIATES
 PO Box 694 Cleburne TX 76031
 817 295-7771
 STL, remote control and SCA subcarrier equip VS

BECAUSE "SOUNDS GOOD" IS NOT GOOD ENOUGH.

Now there's a simple, inexpensive, and reliable way to help assure the quality sound that captures listeners...and holds them.

The new Fidelipac Wow & Flutter Meter, the standard in sound performance measurement, makes it possible. And does it by enabling you to easily, quickly and confidently measure the wow and flutter components in all types of recording and playback devices.

The Fidelipac Wow & Flutter Meter will prove itself quickly, no matter what kind of equipment you want to test. Tape equipment? The Wow & Flutter Meter will allow adjustment of pinch-roller pressure and check motor shaft anomalies. Tape equipment and projectors? The Wow & Flutter Meter checks bearing irregularities and measures scrape flutter, and reel warp and spooling variations. Turntables? The Wow & Flutter Meter detects worn idler wheels or drives with flat spots, and measures

machining irregularities in platters.

This feature-packed, lightweight, portable instrument incorporates a single meter readout and an innovative state-of-the-art precision zero-center drift meter to track deviation from a device's true speed within a 5% range. Add to that an internal 3,150 Hz reference oscillator, self-contained switchable weighting filter, and an output jack for oscilloscope connection — packaged in an all-metal interlocked unit to assure immunity to EMI and RFI, and you understand why the Fidelipac Wow & Flutter Meter is simply the best price-performer you can buy.

And it's available now, for only \$425, for engineering and technical managers who understand that quality sound equals quality listening.

Contact your Fidelipac distributor or use the handy coupon below.

THE WOW & FLUTTER METER FROM FIDELIPAC THE NEW IDEA IN FINE TUNING



FIDELIPAC
 Fidelipac Corporation
 109 Gaither Drive
 Mr. Laurel, NJ 08057 USA
 609-235-3511
 TWX/TELEX 710-897-0254
 (Fidelipac MTLR)

SOUNDS GOOD TO ME.

- Send me a Wow & Flutter Meter today, for \$425.00 postpaid.
- I have enclosed a check/money order.
- Please charge it to my
 - VISA Master Charge Credit card # _____
- Send more information.

Name _____ Title _____
 Station _____ Telephone _____
 Address _____
 City _____ State _____ Zip _____

FIDELIPAC Fidelipac Corporation, 109 Gaither Drive, Mr. Laurel, NJ 08057

The Source '80

MICRODYNE CORP

PO Box 7213 Ocala FL 32672
904 687-4633

Satellite receive only earth stations

MICROFLECT CO INC

3575 25 St SE Salem OR 97302
503 363-9267

Transmission line and connectors; towers, tower hardware & construction equip VS

MICROPROBE ELECTRONICS INC

Suite 1532A 875 N Michigan Ave Chicago IL 60611

312 440-3111

Automation controllers, computer/microprocessor; complete automation systems VS

MICROTIME INC

1280 Blue Hills Ave Bloomfield CT 06002
203 242-4242

Digital video noise reducers; dropout compensators; image enhancers; frame synchronizers; TBCs (helical capstan servo, helical non-servo capstan, quad); digital video effects; video scramblers & descramblers VS

See ad pg 156 — refer to rep/dist section

CA	G Johnston Irvine 92715.....	714 551-8782
CT	D Sofie Bloomfield 06002.....	203 242-4242
FL	W Baird Clearwater 33516.....	813 535-5990
IN	A Kartes Noblesville 46060.....	317 776-0079
NY	D Leeson Liverpool 13008.....	315 457-9405

MICRO-TRAK CORP

620 Race St Holyoke MA 01040
413 536-3551

Audio dist amps; audio consoles (mono, stereo, audio for TV); portable & sportcaster consoles; studio cabinets & furniture; audio cart storage; racks, cabinets & shipping cases; turntables, pickup arms; turntable preamps & controls; complete disc consoles VS

See ad pg 199

MICROTRAN CO INC

145 E Mineola Ave POB 236 Valley Stream NY 11582

516 561-6050

Audio tape bulk erasers & head degaussers; full line transformers VS

MICROVISION SYSTEMS

PO Box 1676 San Mateo CA 94401
415 348-1344

Videotape editor controller

MICROWAVE ASSOC COMM CO

63 Third Ave Bldg 5 Burlington MA 01803
617 272-3000

Microwave equip (intercity, portable, ENG, airborne); microwave supports & portable equip; RF program subcarrier; microwave antennas VS

MICROWAVE ASSOCIATES INC (LAND MOBILE COMMUNICATIONS DIV)

1362 Borregas St Sunnyvale CA 94086
408 734-4220

UHF/VHF transmitter combiners, receiver combiners, isolators, circulators; RF filters, loads, terminations, power meter panels VS

MICROWAVE POWER DEVICES INC

330 Oser Ave Hauppauge NY 11787
516 231-1400

Microwave power amps; RF amps; FM, TV transmitters

MID-STATE COMMUNICATIONS

PO Box 203 Beech Grove IN 46107
317 787-9426

FM & TV field intensity meters; frequency monitors & counters; spectrum analyzers; RF generators VS

L MATTHEW MILLER ASSOC LTD

Ste 1316 205 E 42 St New York NY 10017
212 687-1168 800 223-0620

Video production & post-production equipment rental sales VS

See ad pg 198

MILLER-STEPHENSON CHEMICAL CO INC

Geo Washington Hwy Danbury CT 06810
203 743-4447

Degreaser, head cleaner; contact cleaner

MINNEAPOLIS MAGNETICS INC

3104 W Lake St Minneapolis MN 55416
612 927-8841

Replacement & rebuilt audio tape heads VS

MODULAR AUDIO PRODUCTS

50 Orville Dr Bohemia NY 11716
516 567-9620

Audio dist. line, monitor & power amps; preamps; amplifier power supplies; AM & FM compressor/limiters; graphic equalizers & filters; audio consoles (stereo & mono studio multi-output; audio for TV) VS

See ad pg 90—refer to rep/dist section

MODTEC—See Broadcast Electronics

MOHAWK WIRE & CABLE CORP

PO Box 707 Leominster MA 01453
617 537-9961

Wire and cable VS

MOLE-RICHARDSON CO

937 N Sycamore Ave Hollywood CA 90038
213 851-0111

Lighting fixtures; lighting kits; stands, hangers & adapters; pattern lights; grip equip; special effects; Molecolor filters VS

VS MEANS IT'S VERIFIED

It takes more than steel...

Tough steel is great for towers. But it takes tough *people* to build towers that out-perform the competition.

Stainless has that kind of people. Tough, uncompromising perfectionists in design, site evaluation, selection of materials, fabrication and cost control.

This "tough" Stainless team has earned us our solid reputation, meeting and exceeding industrial and government requirements in CATV, AM/FM, TV and microwave, worldwide, for over 30 years.

For better towers, call Stainless... the "Tough" guys in the tower business.

$s = Mc/I$

The Tower People
Stainless, inc.

North Wales, PA 19454 U.S.A.
Phone: (215) 699-4871 • TWX: 510-661-8097

C0180

Circle 169 on Reader Service Card

the new **CD-480-4**

another
smart switcher
from CDL

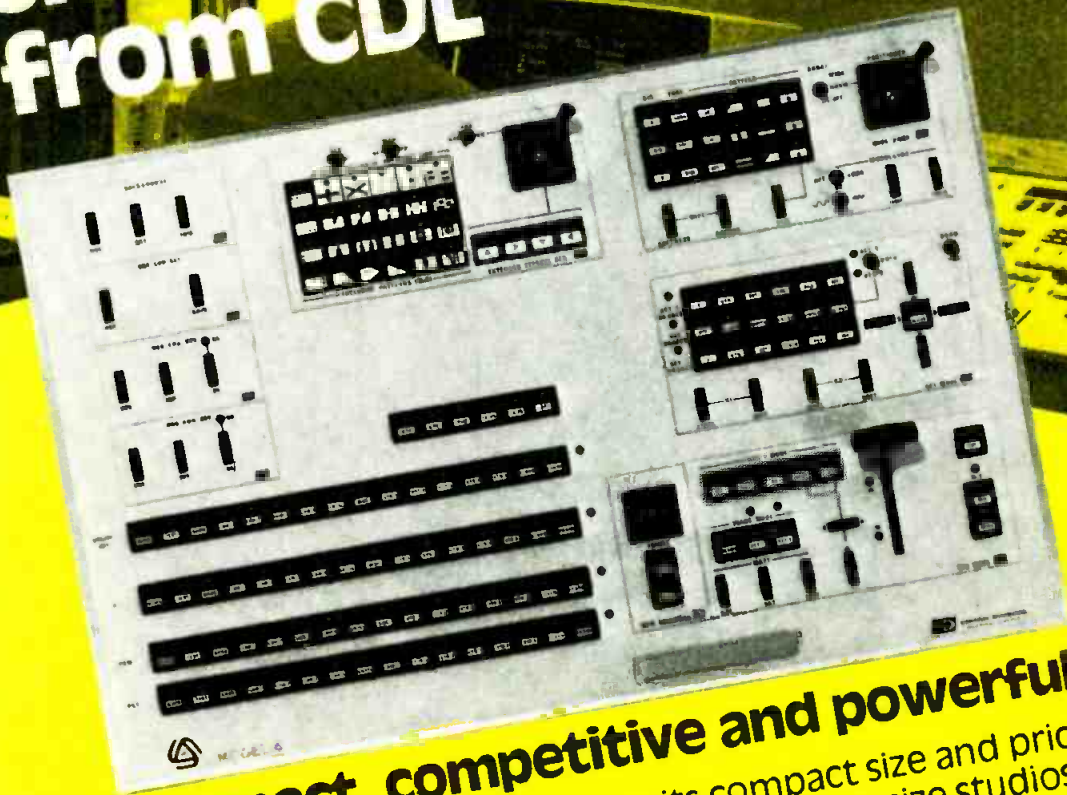

compact, competitive and powerful

The power of the CD-480-4 plus its compact size and price make it the professional choice for medium size studios, post production suites and mobile vans.

Powerful: includes the unique CD-480 SFX amplifier that permits you to control 4 video signals, in any combination, with one fader handle, plus a wide range of powerful CD-480 modular options.

Compact: 24" wide panel and 21" of rack electronics.

Price: Also compact and competitive... ask us.

The CD-480 gives you the competitive advantage.

Central Dynamics, 10 W. Main St., Elmsford, NY 10523, 914-592-5440
Chicago: 312-991-4720, Los Angeles: 213-789-0574, Atlanta: 404-491-9037
Dallas: 214-741-3332, Denver: 303-623-7603, CANADA-Montreal: 514-697-0810

CENTRAL DYNAMICS



The Source '80

MONEY MACHINE

PO Box 23355 Nashville TN 37702
800 251-2058

Syndicated radio programming services VS

MONROE ELECTRONICS INC

100 House I Ave Lyndonville NY 14098
716 765-2254

Unattended phone answering devices, tone signal generators, detectors, timers, comm & monitor receivers; remote control & monitoring systems VS

See ad pg 14

MOOG MUSIC INC

2500 Walden Ave Buffalo NY 14225

716 681-7200

Music synthesizers

MOSELEY ASSOCIATES INC

111 Castilian Dr Goleta CA 93017
805 968-9621

ALC & AGC amps; AM & FM compressor/limiters; microwave equip (intercity, portable, ENG & airborne); RF program subcarrier; remote control systems; remote pickup equip; RF amps; FM & TV SCA equip; microwave STLs VS

See ad pg 188

MOTOROLA COMM AND ELECTRONICS INC

1301 E Algonquin Rd Schaumburg IL 60196
312 397-1000

Monochrome monitors; remote pan & tilt systems; receivers, comm & monitor; remote pickup equip; two-way radio communications; communications

antennas; frequency monitors & counters; RF generators; modulation monitors; oscilloscopes; RF wattmeters; spectrum analyzers; voltmeters, multimeters; waveform monitors & analyzers VS

MPB TECHNOLOGIES INC

PO Box 160 Ste Anne de Bellevue Que H9X 3L5
514 457-2035

Character/graphics systems; software; VS

MPCS VIDEO IND INC

514 W 57 St New York NY 10019
212 586-3690

Production equip rental; post-production services; TV studio design; video tape/film recording transfer; video camera & monitor modification; distributor of full line of video equip VS

MSI TELEVISION DIV OF COM TEL INC

4788 S State St Salt Lake City UT 84107
801 262-8475

Alphanumeric generators; microprocessor memory controller systems; slide & card advertising systems

MU-DEL ELECTRONICS INC

2426 Linden Ln Silver Spring MD 20910
301 587-6087

RF amps; RF attenuators; diplexers; RF converters; TV combiners; RF filters VS

MULTIDYNE ELECTRONICS

PO Box 528 Locust Valley NY 11560
516 671-7278

Audio line & dist amps, power supplies; low frequency extenders; titlers; video dist & subcarrier amps; SMPTE time code readers; sync, color bar, black burst & multiburst generator systems; video equalizers; digital clocks; master & slave clocks; timers; time dist systems VS

MULTIPLIER INDUSTRIES CORP

464 S 10 Ave Mt Vernon NY 10550
914 699-0990

Battery supplies for production equip.; batteries for emergency power; instrument protection cases; rechargeable Ni-cad transceiver batteries for portable two-way radios VS

MULTI-TRACK MAGNETICS INC

3 Industrial Ave Upper Saddle River NJ 07458
201 327-9400

SMPTE time code generators; motion picture & flickerless film projectors; magnetic recording equip & accessories; facility turnkey installation; film post-production services VS

MXR INNOVATIONS INC PROFESSIONAL PRODUCTS GROUP

740 Driving Park Ave Rochester NY 14613
716 254-2910

Digital audio delay system; pitch shifting device and flanging/doubling device for special effects; graphic equalizers; dual limiter VS

N

NADY SYSTEMS INC

1145 65 St Oakland CA 94608
415 652-2411

Wireless mics VS

NAGRA MAGNETIC RECORDERS INC

19 W 44 St New York NY 10036
212 840-0999

Miniature open-reel audio/cine recorders; hand-held mixers; lavalier mics, tape reels, tape timers; portable open-reel tape player/recorders VS

NAGY RESEARCH PRODUCTS

PO Box 289 Mclean VA 22101
703 356-3963

Tape splicers

NAKAMICHI USA CORP

1101 Colorado Av Santa Monica CA 90401
213 451-5901

One-output mic mixers; headphones; mics (dynamic, condenser/electret, shotgun); noise reduction systems; audio cassettes & test tapes; tape alignment gauges; single audio cart player/recorders; head degaussers; harmonic distortion meters; wow & flutter meters VS

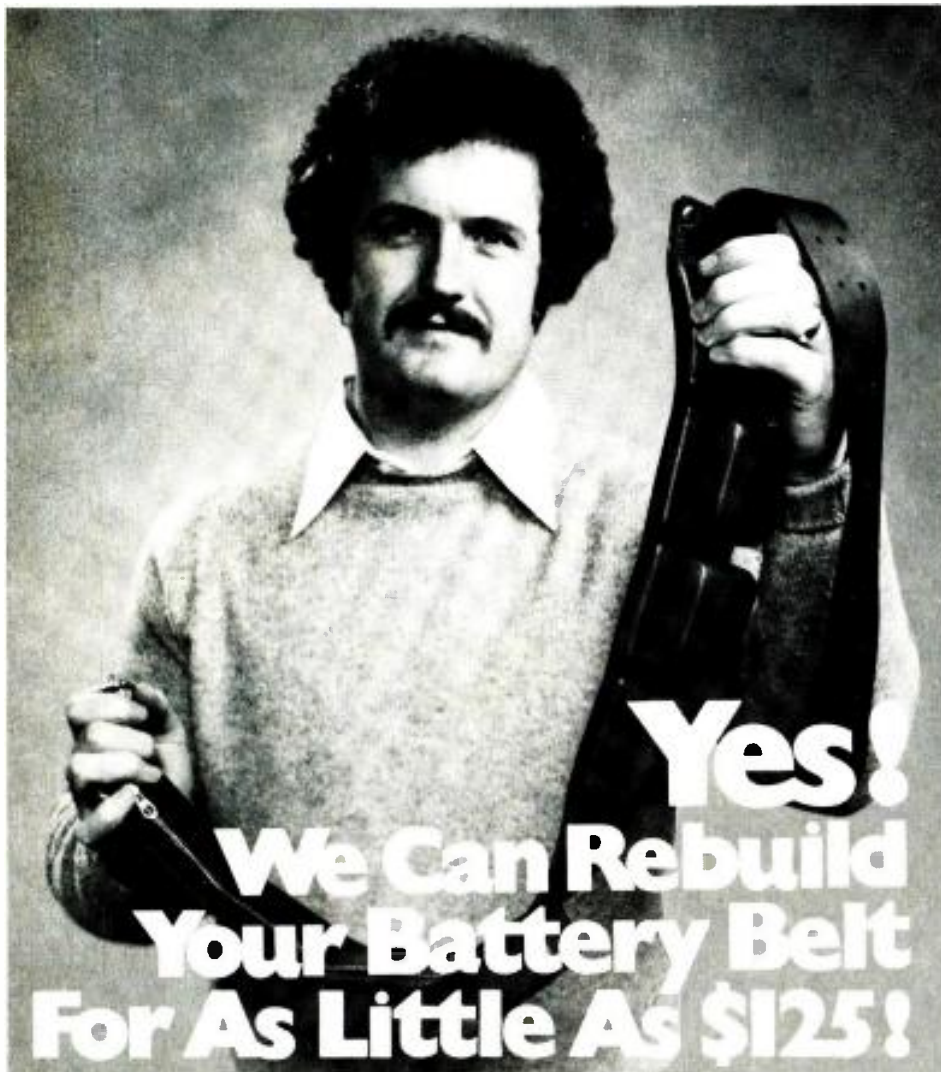

Before giving up on that old battery belt, ship it to Alexander. Chances are, we can rebuild and return within one working day. It's a lot cheaper than buying a new belt — as little as \$125 in some cases. And we use new batteries that meet or exceed original specs. Call us about your sick and dying belt.



ALEXANDER

Alexander Manufacturing Co.
Box 1645 — 1511 So. Garfield Pl
Mason City, Iowa 50401
Phone (515) 423-8955

Circle 171 on Reader Service Card



Even the best copy
may not be perfect.

Insist on the original.

Ever since Cine 60 invented the Powerbelt 20 years ago there have been imitations. And while we're flattered that so many have tried to follow our lead, we'd like to set the record straight. Cine 60, the original, has:

The broadest line of proven products



Cine 60 offers you maximum flexibility, maximum reliability. From our Fast Charge Powerbelts that can be charged in less than an hour, to our light, bright portable lighting kits. On-Board batteries for all popular ENG and EFP cameras. In-Boards for VTR's. Dememorizers to restore "new" battery performance. Car Fast Chargers for recharging from any vehicle. State-of-the-art high frequency chargers that are half the weight and size of competitive units.

Nobody else comes close to Cine 60's record of reliability. Our high value, high performance nickel-cadmiums have logged more hours, powered more cameras, shot more footage



Chances are we've solved the problem before.

Readily available parts and service - Coast to Coast

New York, Hollywood or in between. Cine 60 stocks complete parts for all our products. Trained technicians can rebuild our belts with original equipment quality cells, quickly, economically. Cine 60 also maintains a complete stock of all our belts, packs and related products, from 4 to 20 amp hours.



If you ever need help, one call will get you the belt you want shipped in 24 hours in most cases. That's the kind of instant response that separates the pros in portable power from the rest of the pack. With all you've got riding on a shot, settling for anything less than the original is a compromise you can't afford.

CINE 60

INCORPORATED
The Original

630 Ninth Ave., New York, N.Y. 10036
Telex 645647 & TWX: 7105816073
(212) 586-8782

6430 Sunset Blvd., Hollywood, Calif. 90028
(213) 461-3046, Cable: CINEBELTS



Circle 172 on Reader Service Card

The Source '80

NATIONAL ELECTROLAB DIV TELE-RADIO SYSTEMS LTD

1536 Columbia St No Vancouver BC V7J 1A4
604 985-0511

Audio monitor, RF receivers, comm & monitor, RF amps

NATIONWIDE ELECTRONIC SYSTEMS INC

1536 Brandy Parkway Streamwood IL 60103
312 289-8820

Automated test & measurement systems; digital clocks; master & slave clocks; timers; time distribution systems; log printers; voltmeters & multimeters

VS

NEAL FERROGRAPH USA INC

652 Glenbrook Road Stamford CT 06906
203 348-1045

Audio tape recorders, open-reel & cassette, variable speed 1/4-in audio recorders, metal tape cassette recorders, 3-4 channel cassette player/recorders; tape logging equip; multitest audio sets

VS

See ad pg 116

NEAS

Wilkes-Barre/Scranton Airport Avoca PA 18641
717 826-1616

Complete automation systems; TV business computer services equip

VS MEANS IT'S VERIFIED

NEC AMERICA INC BROADCAST EQUIP DIV

130 Martln Lane Elk Grove Village IL 60007
312 640-3792

ENG/EFP cameras; digital video noise reducer; dropout compensators; video proc amps; large production switchers; video pulse & dist amps; routing switchers; special effects gens; frame synchronizers; TBCs (helical capstan servo, helical non-servo capstan, quad); video delay lines; digital video effects; repositioners; compressors; one-inch segmented helical VTRs, FM & TV exciter; portable, ENG & airborne microwave equip; TV combiners; receive-only satellite earth stations; translators; AM, FM, VHF & UHF transmitters; telephone video system for teleconferencing

VS

See ad pg 81 — refer to rep/dist section

CA Hugh Gillogly 17206 Pinot Pl Poway
92064714 485-9501

NETWORK RECORDING PRODUCTS & PRODUCTION MUSIC

4429 Morena Blvd San Diego CA 92117
714 272-2011

Audio special effects; open-reel audio tapes, carts, cassettes & test tapes; empty reels, carts & cassettes; leader tapes; production music library; new videotape

VS

NEUMADE PRODUCTS CORP

720 White Plains Rd Scarsdale NY 10583
914 725-4900

Storage & filing cabinets for tape reels, cassettes, carts, rewriter; film cases, cleaners & editing equip; film inspection equip; racks, cabinets & shipping cases

RUPERT NEVE INC

Berkshire Ind Park Bethel CT 06801
203 744-6230

Audio dist amps; AM & FM compressor/limiters; parametric equalizers & filters; full line audio consoles; open-reel audio tape

VS

See ad pg 11

CA 7533 Sunset Los Angeles
90046 213 874-8124
TN PO Box 120907
Nashville 37212 615 385-2090
CAN 2721 Rena Rd Malton
ONT L4T 3K1 416 677-6611

NEWMAN/LUSTIG & ASSOC

1050 N State St Chicago IL 60610
312 642-5364

Mobile van construction; TV studio design

NEWSCAN

3317 N Shartel Ave Oklahoma City OK 73118
405 525-9783

Full electronic graphics system; animation; newsroom computers; weather info, service

VS

NIDUS BROADCAST SYSTEMS

11465 W 48 Ave Wheat Ridge CO 80033
303 422-6889

Computer/microprocessor automation controllers; complete automation systems; radio & TV business computer services

VS

NIKKO AUDIO

16270 Raymer St Van Nuys CA 91406
213 988-0105

Audio preamps & power amps; passive equalizers & filters; mono, stereo & quad consoles; turntables

VS

NORCOM MANUFACTURING

PO Box 804 Brainerd MN 56401
218 829-9675

Audio consoles (one-output mic mixers, portable); telephone coupling equip

NORTH AMERICAN PHILIPS CORP—See AKG Div & Philips Audio Video Systems

NORTH AMERICAN TURBINE CORP

PO Box 40510 11500 Charles St Houston TX
77040

713 466-6200

Emergency generator systems

editors' choice.

COMMANDER II

— the market's newest video tape editing system offers some significant differences.

United Media has taken a totally new look at the desires and requirements of the industry in developing Commander II. The results — a technologically superior editing system at a significantly lower price.

Like \$40,000 for a complete 4VTR system — any combination of playback and record for multiple format masters (expandable to 3 more VTR's plus switcher).

Like automatic switcher control for double re-entry with 3 independent M/E amplifiers.

Like video levels variable in 10% increments with mix rates from 1 to 999 frames.

Like automatic cut listing with a single keystroke — and automatic list management for shortening, lengthening or rearranging scenes.

Now editors can have a real choice. judge for yourself — call Bob Ricci at 714/630-8020 today.



United Media
4075 Leaverton Court, Anaheim, CA 92807

Circle 173 on Reader Service Card

DELTA BROADCAST PRODUCTS

AMC-1



The **Amplitude Modulation Controller** is the only modulation controlling system that provides a completely closed loop around the transmitter. The sampling of actual modulation levels after the PA output network assures precise adjustment for optimum modulation levels. The AMC-1 also keeps a digital count of positive and negative overmodulation bursts for both present and previous one minute periods.

DAM-1



The **Digital Antenna Monitor** couples pushbutton ease of operation with digital accuracy. The DAM-1 will accept RF samples from up to 12 towers (with an auxiliary panel) and features $\pm 1^\circ$ phase and $\pm 2\%$ current ratio accuracies. Remote panels and other accessories are available.

AAM-1



The **Analog Antenna Monitor** gives stable phase and ratio readings even in high RF fields. Separate phase and ratio mirrored-scale meters assure accurate meter indications.

TMCS



The **TMCS Antenna/Transmitter Remote Control System** offers complete transmitter and antenna parameter control for stations utilizing the DAM-1 Antenna Monitor. Alarm indications and failsafe circuitry is also provided, giving complete transmitter system control.

APC-1



The **Automatic Power Controller** is your insurance against citations for over- and under-power operation. The APC-1 continuously monitors the transmitter output power, and makes automatic power adjustments with the transmitter loading control. This assures proper power adjustment at all times.

6730-E
6740-B



Designed to switch two transmitters from antenna to dummy load, the 6730E interfaces with 1 5/8 inch coaxial cable. For 3 1/8" lines, the 6740-B transfer switch is used. Either manually or remote controlled, the **Transfer Switch** is fully interlocked and can be wired to existing equipment to prevent "hot" switching.

TCA

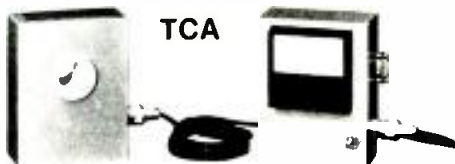

State of the art antenna current metering has arrived in the **TCA Ammeter Systems**. Accurate, Modulation-free, temperature stable current indications are found in the TCA. Models include single and dual scale meters.

TCT



Delta's **Toroidal Current Transformers** provide accurate sampling current and phase values without the problems associated with sampling loops. Three output voltage ranges are available, as well as high voltage models for high-power facilities.

OIB-3



OIB-1

The **Operating Impedance Bridge** measures the impedance of networks, radiators, and the like while they operate under full power. VSWR as well as complex impedances of up to $400 \pm j300$ ohms can be measured.

The **OIB-3 Operating Impedance Bridge** provides extended resistance and reactance ranges, measuring up to $1000 \pm j900$ ohms. The bridge has a built-in carrying case and RF amplifier for improved nulling.

RG-3



The **Receiver/Generator** combines a two-watt RF output and a correlation detector circuit that virtually eliminates interference problems. The RG-3 can be used in conjunction with any conventional impedance bridge including the OIB series.

CPB-1



The **Common Point Impedance Bridge** is designed for permanent installation; and allows continuous monitoring of the common point, thus facilitating network adjustment. This model can be provided with one of Delta's TCA ammeters mounted in the front panel.

DPM-1

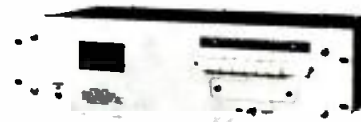

Delta's **Digital Panel Meter** displays up to sixteen channels of information in a 3 1/2 digit LED display. Any combination of operating parameters can be selected, such as plate current and voltage, common point current, base currents, etc.

DELTA ELECTRONICS



5730 GENERAL WASHINGTON DRIVE
P.O. Box 11268 • ALEXANDRIA, VIRGINIA 22312
TELEPHONE: 703-354-3350 TWX: 710-832-0273

Circle 174 on Reader Service Card

The Source '80

NORTH HILLS ELECTRONICS INC

Alexander Pt Glen Cove NY 11542
516 671-5700

Video pulse & dist amps: RF amps: hum bucking coils: transformers VS

NORTH WIND POWER CO INC

PO Box 315 Warren VT 05674
802 796-2955

Battery supplies for production equip & emergency power: wind-driven power generators: remote power system design VS

VS MEANS IT'S VERIFIED

NORTON CO AIR SPACE DEVICES

PO Box 7500 Cerritos CA 90701
213 926-0545

Tower accessories: safety devices: climbers

NORTRONICS INC RECORDER CARE DIV

8101 Tenth Ave N Minneapolis MN 55427
612 545-0401

Magnetic test tapes: tape cleaners: cleaning & evaluating services: replacement audio tape heads: splicing blocks & tape: head degaussers & bulk erasers: VTR head cleaners VS

NOVA CORP

5801 Uplander Way Culver City CA 90230
213 641-2046

Videotape cleaner attachment for VTR: audio de-popping for VR-1200/2000: speaker intercoms VS

NTI AMERICA INC

1680 N Vine St Suite 202 Los Angeles CA 90028
213 462-8945

Digital signal generators for color & mono video: color time coder VS

FRED A NUDD CORP

1743 Route 104 Ontario NY 14519
315 524-2531

Towers: tower hardware & construction equip VS
See ad pg 178

NURAD INC

2165 Druid Park Dr Baltimore MD 21211
301 462-1700

Quad polarized antennas for remote TV broadcasting: helical and parabolic ENG transmit antennas: airborne microwave links: complete microwave TV system design and turnkey installations VS

NYTONE ELECTRONICS CORP

2424 S 900 W Salt Lake City UT 84119
801 973-4090

Color studio cameras VS

0

OAK COMM INC CATV DIV

100 S Main Crystal Lake IL 60014
815 459-5000

Decoders, converters & addressable systems for STV and cable & pay TV

OAK INDUSTRIES INC SWITCHER DIV

100 S Main Crystal Lake IL 60014
815 459-5000

Rotary and pushbutton switchers

OCEAN REALM SYSTEMS

Box 370293 Miami FL 33137
305 573-2767

Underwater video systems VS
See ad pg 201

O'CONNOR ENGINEERING LABS INC

100 Kalmus Dr Costa Mesa CA 92626
714 979-3993

Camera tripods and heads VS

OKI ELECTRIC INDUSTRY CO LTD

3 University Pl Hackensack NJ 07601
201 646-0011

TV standards converter VS
See ad pg 54

OKTEL CORP

490 Division St Campbell CA 95008
408 374-1811

Slow mo, variable speed & time lapse video action recorders: electronic still stores: weather radar VS

OLESEN

1535 Ivar Ave Hollywood Ca 90028
213 461-4631

Lighting hardware, lighting equip, filters, dimmer controls: fabrics, cycloramas: rental service: prefab scenery

ONAN CORP

1400 73 Ave NE Minneapolis MN 55432
612 574-5000

Emergency standby power generators

OPAMP LABS INC

1033 N Sycamore Ave Los Angeles CA 90038
213 934-3566

Full line audio amps, power supplies, slide attenuators: ALC & AGC amps, active equalizers & filters, reverb units: video dist. amps

OPTEK

1390 N McCan St Anaheim CA 92806
714 630-8280

Bulk erasers: video head alignment gauge

OPTIMA ENCLOSURES DIV

SCIENTIFIC-ATLANTA INC
2166 Mountain Industrial Blvd Tucker GA 30084
404 939-6340

Racks, equip enclosures, cabinets VS

better believe it!

**The Ferrograph RTS2
test set can reduce
audio test time up to 30%.**

Here's how. You connect only a single input and output lead to the component under test. You perform all routine checks for frequency response, distortion, wow and flutter, signal-to-noise ratio, drift, gain, input sensitivity, output power and more just by pushing buttons with this single instrument. You read the results directly in percent or dB so there's no arithmetic or guesswork.

Ferrograph RTS2 speeds your testing of tape recorders in all formats, turntables, preamps, line and power amps, equalizers and other signal processing components. It's easier and faster to use than separate test instruments; yet, it costs far less than other all-function test sets. For complete specifications, and details about how you can acquire the RTS2 at no risk, circle reader service number or contact: Neal Ferrograph USA, Inc. 652 Glenbrook Road, Stamford, Connecticut 06906, (203) 348-1045/Telex: 64-3678.

**NEAL
FERROGRAPH**

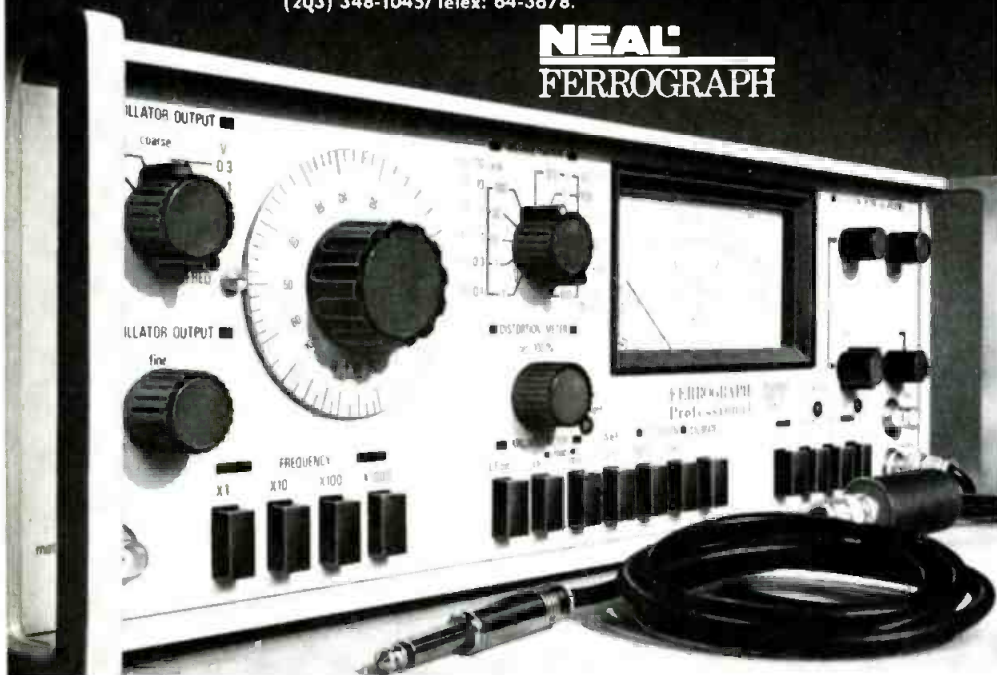

Circle 175 on Reader Service Card

If you think their character generator is easy to operate, just go ahead and exawkm.



Before you invest in a top of the line character generator, you should know more than just what it can do. That's why the versatile new 3M D-8800 character generator could be just the one for you. You see, all instructions are in English, not in code. And we've put them on a convenient L.E.D. panel above the keyboard for less wasted eye motion. So even a beginner can soon be composing in all kinds of fonts and colors. See your 3M representative right away for the character generator any of your people can run, or call 612-736-1032 for more information. Unless of course, you'd rather exawkm.

3M

Circle 176 on Reader Service Card

www.americanradiohistory.com

The Source '80

ORANGE COUNTY ELECTRONICS INTL INC
2100 W 98 St Minneapolis MN 55431
612 881-6040

ALC & AGC amps; AM & FM compressor/limiters; parametric equalizers & filters; audio special effects; noise reduction systems; signal equalizing systems; magnetic recording equip & accessories **VS**

ORBAN ASSOCIATES INC

645 Bryant St San Francisco CA 94107
415 957-1067; 800 227-4498

ALC & AGC amps; AM & FM compressor/limiters; graphic & parametric equalizers & filters; mechanical reverb & audio special effects; FM processors & stereo generators **VS**
See ad pg 187. Contact main office for nearest dealer.

OREGON MAGNETICS
PO Box 13374 Portland OR 97213
503 236-0000

V-lock adaptor for helical scan VTRs

ORROX CORP—See CMX

OTARI CORPORATION
1559 Industrial Rd San Carlos CA 94070
415 592-8311

Open-reel audio tape player/recorders (portable & studio systems); tape duplicators **VS**
See ad pg 63—refer to rep/dist section

P

PACE WIRE AND CABLE CORP
3590 Ocean Rd Oceanside NY 11572
516 678-2275
Wire and cable

PACKAGED LIGHTING SYSTEMS INC

PO Box 285 Walden NY 12586
914 778-3515

Lamps; lighting hardware & accessories; manual lighting control systems; dimmer packs **VS**

PACIFIC RECORDERS & ENGINEERING CORP

11100 Roselle St San Diego CA 92121
714 453-3255

Audio dist amps; ALC & AGC amps; multi-output stereo studio consoles; single cart players/recorders; facility turnkey installation; cabinets & furniture; radio studio design **VS**
See ad pg 140

PAKO CORP

6300 Olson Memorial Hwy Minneapolis MN 55410
612 540-6300

Film processors; slide mounting systems

PALADIN CORP

31332 Via Colinas Westlake CA 91361
213 991-4970

Tools **VS**

WA PALMER FILMS INC

611 Howard St San Francisco CA 94105
415 986-5961

16 mm film telecine projectors; video/film recording camera; motion picture projectors; film labs; film post-production services; videotape/film recording transfer **VS**

PANASONIC CO

One Panasonic Way Secaucus NJ 07094
201 348-7000

Audio preamps, line amps; audio consoles (mic mixers, portable); full line disc playing equip; dynamic & condenser/electret mics; speakers; color studio cameras; monochrome cameras; ENG/EFP cameras; tripods; video camera lenses; camera power packs; RGB chroma keyers; monitors (b&w, color, dc portable); remote pan & tilt systems; SMPTE time code reader/gens; special effects gens; sync & color bar generator systems; time lapse video action recorders; large screen projectors; video equip carrying cases; new videotape; two-VTR editor/controllers; multi-source video editors; computerized auto assembly editors; U-type & half-inch VCRs **VS**
See ad cover 2

CA	Pan 8383 Wilshire Blvd Beverly Hills 90211.....	213 655-1111
GA	Pan #1 Meca Way Norcross 30093.....	404 923-9700
HA	Matsushita Elec 320 Waiakamilo Rd Honolulu 96817.....	808 847-5361
IL	Pan 425 E Algonquin Rd Arlington Heights 60005.....	312 364-7900
MA	Pan 75 University Ave Westwood 02090.....	617 326-4000
MD	Pan 11 Azar Ct Baltimore 21227.....	301 247-4300
NY	Pan 50 Meadowlands Pky Secaucus NJ 07094.....	201 348-7000
PR	Ave 65 de Infanteria Km 9.7 Victoria Ind Pk Carolina 00630.....	809 769-4320
TX	Pan 1825 Walnut Hill Ln Irving 75062.....	214 258-2828

PANDUIT CORP

17301 Ridgeland Ave Tinley Park IL 60477
312 532-1800

Nylon cable ties, accessories; plastic wiring duct; terminals; wire markers; electronic connectors

PANEL COMPONENTS CORP

PO Box 6626 Santa Rosa CA 95406
707 523-0600

Electrical connectors **VS**

PANOAK LIGHTING SYSTEMS & SUPPLY

6809 E 40 St Tulsa OK 74145
918 664-1111

Lamps; lighting control systems (manual, automated & dimmer packs); lighting heads, stands & fixtures; diffusion material, gels & filters/special effects; patch terminals; plugs & connectors; seamless materials; TV studio design; 19-inch equip racks; cabinets & furniture; wire & cable **VS**



An idea whose time has come . . . again!

The Merlin ME-188 Drop Out Compensator.

Since the introduction of the first drop out compensator, videotape has steadily improved, leading some to think the DOC is obsolete. But, the demands being placed on tape recording have also multiplied . . . especially in the case of the new one-inch broadcast VTR's which require increased density of recorded material.

While based on a proven concept, the Merlin ME-188 is a modern, state-of-the-art analog drop out compensator with a single line delay. Unlike a digital DOC, it can replace any drop out with information of the correct color phase and horizontal timing from the adjacent line. The whole line is not replaced—only an insertion just long enough to cover the drop out.

The ME-188 is small, self-contained and supplied with the appropriate interface for any broadcast quad or helical scan VTR at an old-fashion price . . . \$4000 complete.

Call toll free, 800-227-1980 for ordering information.
(In California, call 415-856-0900, collect.)

MERLIN

MERLIN ENGINEERING WORKS 1880 EMBARCADERO ROAD, PALO ALTO, CA 94303

Merlin Engineering has a full range of products and assemblies for bringing your broadcast VTR up to date, as well as complete engineering facilities for custom applications. Write for your copy of the 1980 Merlin catalog.

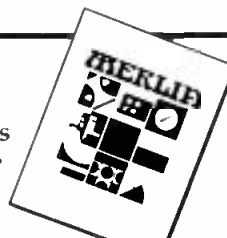

Circle 177 on Reader Service Card

"FAST, FLEXIBLE, ACCURATE..." MACH ONE AT ASTIN/MOORE.

When Astin/Moore designed its modern post-production facility, they wanted a *software-oriented* computer-assisted video editing system to interface with their Bosch "B" format one-inch VTRs.

Director of engineering Dave Orr chose the Fernseh, Inc./Mach One™ videotape editing system.

"We needed a system that was *fast, flexible and accurate*, and on which program changes could be made easily and quickly. Mach One fills the bill."

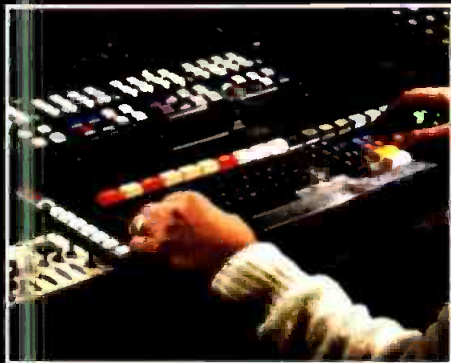

A/M's Emmy-award-winning chief editor Marco Zappia heartily agrees.

"The Mach One's dedicated keyboard with single-key functions makes editing fast and simple. I can edit as fast as my fingers can move,

and this has helped my rapport with producers and directors. If someone says, 'Okay, I'll take that,' I still have time to say, 'Well, look at this, too!'

"Everything about the Mach One system is geared to speed, and that can be translated into creativity, making for an extremely cost-effective operation.

"The system takes best advantage of the rapid roll time of the VTRs, and it parks very accurately . . . right on frame."

If your editing system is bottlenecking your video post-production output, switch to Mach One. You'll discover more control-room flexibility and freedom than you've ever known.

For descriptive literature, please write or call Fernseh, Inc., P.O. Box 15068, Salt Lake City, Utah 84115, (801) 973-4619 or 972-8000; Telex: TM388352 SLC.

FERNSEH INC.

*The Video Corporation of
Bell & Howell and Robert Bosch*



Circle 178 on Reader Service Card

© 1980 Fernseh Inc. All rights reserved.

www.americanradiohistory.com

MARCONI has the proven answer to 'H' & 'V' Blanking Measurements

Marconi Television Interval Timer Model 2920 measures the following parameters

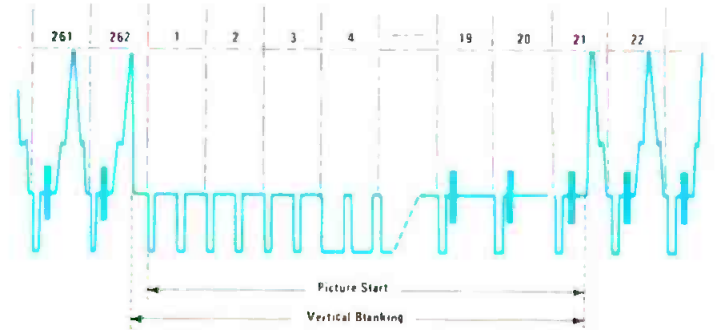

VERTICAL BLANKING MEASUREMENTS

- Total Vertical Blanking Interval
- Picture Start
- Equalizing Pulse Width
- Serration Width

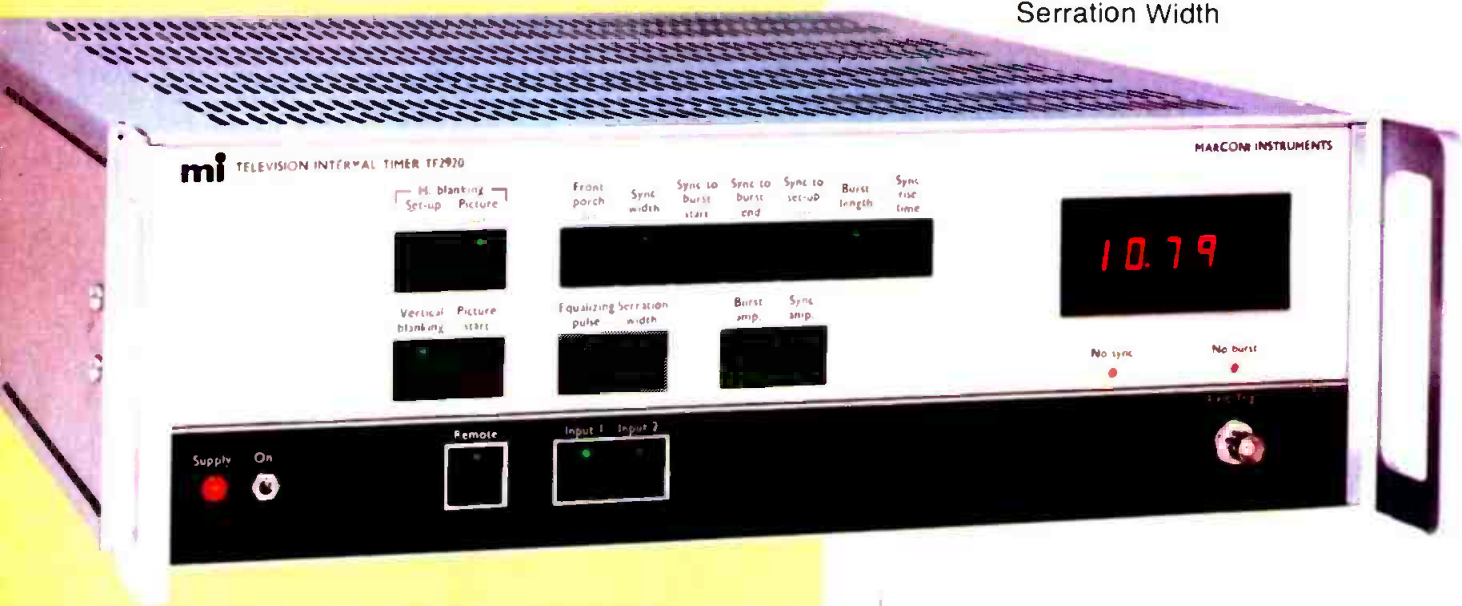

See How Easily Timing Measurements Can Now Be Made

- Fast accurate measurements at the touch of a button
- Results from samples taken throughout active field
- Blanking at set-up (+4 IRE) and picture (+20 IRE) measured independently to 10 nsec. resolution
- Vertical Blanking resolved to 1/10 line
- Printout from BCD output on command
- All functions may be remotely controlled for simple system integration
- Manufactured in U.S.A., domestic price \$4950

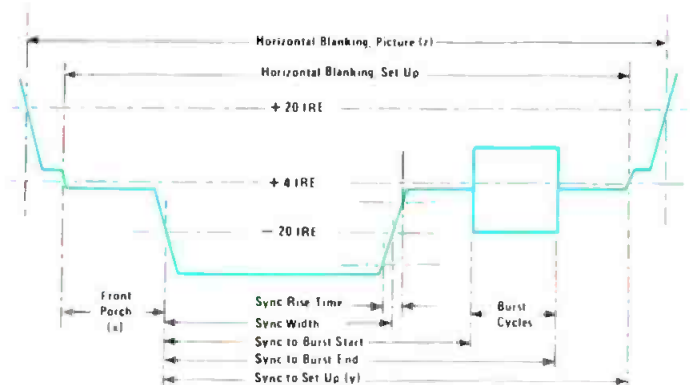

HORIZONTAL BLANKING MEASUREMENTS

- Set Up Blanking (+4 IRE)
- Picture Blanking (+20 IRE), (z)
- Front Porch, (x)
- Sync Width
- Sync to Burst Start
- Sync to Burst End
- Sync to Set-Up, (y)
- Burst Length in cycles
- Sync Rise Time

REFERENCE MEASUREMENTS

- Burst Amplitude in IRE
- Sync Amplitude in IRE

marconi instruments

100 STONEHURST COURT, NORTHVALE, NEW JERSEY 07647
TELEPHONE: (201) 767-7250 • TWX: 710-991-9752

Circle 179 on Reader Service Card

The Source '80

PASO SOUND PRODUCTS INC

14 First St Pelham NY 10803
914 738-4800

Audio preamps & line amps; hardwired intercoms; mics (dynamic, wireless, lavaliere); mic stands, booms & dollies; speakers **VS**

PATRICK COMPUTER SYSTEMS INC

588 Roseberry St Winnipeg Manitoba Canada
204 786-8591

Radio and TV business computer services/equipment **VS**

PAULMAR INC

3316 Commercial Ave Northbrook IL 60062
312 498-1020

Film cases; film cleaners; vertical film editors; film splicing equip.; film inspection equip; film processors **VS**

PEIRCE-PHELPS INC

2000 N 59 St Philadelphia PA 19131
215 879-7171

TV studio design; information systems **VS**

PENNY & GILES

1640 Fifth St Santa Monica CA 90401
213 393-0014

Audio rotary & slide attenuators **VS**

PENTAGON INDUSTRIES INC

4751 N Olcott Chicago IL 60656
312 867-9200

High-speed tape duplicators; audio cassettes

PERROTT ENGINEERING

1020 N Fillmore St Arlington VA 22201
703 528-5861

Power supplies for prod equip, batteries for emergency power; battery chargers **VS**

PHASECOM CORP

6365 Arizona Circle Los Angeles CA 90045
213 641-3501

TV convertors; heterodyne processors; modulators & demodulators; programmable videocassette automation systems

PHELPS DODGE COMMUNICATIONS CO

Rte 79 Marlboro NJ 07746
201 462-1880

FM antennas; transmission lines; RF filters; two-way radio communications; diplexers; communications antennas **VS**

See ad pg 190

CA	1420 Monterey Pass Rd Monterey Park	
	91754	213 268-9330
FL	Route 44 Leesburg	
	32748	904 787-9200

PHILADELPHIA RESINS CORP

20 Commerce Dr Montgomeryville PA 18936
215 855-8450

Non-metallic antenna guys **VS**

See ad pg 94

PHILIPS BROADCAST EQUIP CORP

91 McKee Dr Mahwah NJ 07430
201 529-3800

Color studio cameras; ENG/EFP cameras; digital video noise reducers; complete telecine systems; small production switchers; special effects generators; helical capstan servo TBCs; one-inch helical VTRs; TV excitors; VHF & UHF transmitters **VS**

See ad pg 48

CA	3760 Cahuenga Blvd West	
	No Hollywood 91604	213 766-8185
GA	3300 Northeast Expressway Suite 1G	
	Atlanta 30341	404 458-0171
MD	801 Howard Grove Rd Davidsonville	
	20135	310 956-3065
WI	15611 Fish Point Rd Prior Lake	
	55372	612 447-6036
TX	801 E Woodglen Rte 2 Lewisville	
	75067	817 455-2214

PHILIPS TEST & MEASURING INSTRUMENTS INC

85 McKee Dr Mahwah NJ 07430
201 529-3800

Color encoders; sync generators; color video signal & pattern generators; pulse generators; video level meter; decoder; monitor calibrator; RF generators; demodulator; frequency counters; audio generators; video test equip; multi meters; oscilloscopes; logic analyzers **VS**

PLASTIC REEL CORP OF AMERICA

46 Passaic St Wood Ridge NJ 07075
201 933-9125

Video equip carrying cases; new videotape; videotape reels & storage; film cases & cleaners; film splicing equip; recording & test magnetic film **VS**

CONSTANTINE N POLITES & CO

833 Guenther Ave Yeadon PA 19050
215 626-4643

Lighting heads, stands & fixtures; tower hardware & construction equip; tower lighting **VS**

POLYLINE CORP

1233 Rand Rd Des Plaines IL 60016
312 298-5300

Empty audio reels, carts & cassettes; videotape reels **VS**

PORTA-PATTERN TELECOMMUNICATIONS INDUSTRIES

6822 Santa Monica Blvd Los Angeles CA 90038

213 461-3561

Video test charts & slides **VS**

See ad pg 142

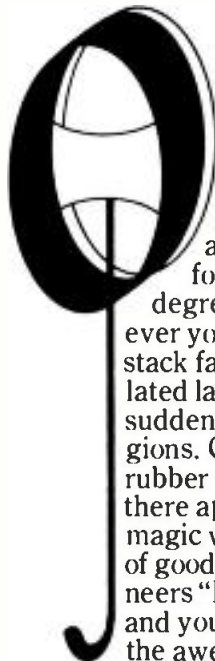

ONCE UPON A TIME, many moons ago, broadcasters could clean out a broom closet and store all of their reels of film and tape. As the stations grew, so did the numbers of things they had to file and store. And everything they stored had to be found and retrieved and used and restored with varying degrees of regularity. Murphy's Law decreed that whatever you must air immediately was on the bottom of the stack farthest from the door in the shadows with a mutilated label. During this time many engineers grew suddenly older and rapidly lost their hair and their religions. Cries of anguish rent the air from stations and from rubber rooms across the land. One bright sunny day there appeared Mother Storeel with her magic wand and cheerful smile and bag of goodies. She bade the harried engineers "Be of good cheer, for I am here, and your wish is my command." As the awe-struck engineers made wishes, lo! their needs were answered with Room Stretchers and Rail Riders and Stor-Max systems by Mother Storeel. And the engineers grew hair again and their hands stopped shaking and their eyes grew bright and their happy laughter was heard again throughout the land. The moral to this story is if you haven't told your wish for maximum-density, ultimate retrieval reel/rack/cart/cassette storage and transportation to Mother Storeel, you've been talking to the wrong fairy.*

When you wish upon a Storeel, your dreams will come true. And that's a fact. Call Mother Storeel NOW at (404) 458-3280 and tell her your wish. And live happily ever after.

STOREROOL CORP
2050-C CARROLL AVE., ATLANTA, GA. 30341



*FAIRY — helpful to chief engineers (WEBSTER).

Circle 180 on Reader Service Card

The Source '80

POTOMAC INSTRUMENTS INC

932 Philadelphia Ave Silver Spring MD 20910
301 589-2662

Patch panels; demodulators; antenna monitors; automated test & measurement systems; diff phase-gain measurement; AM, FM & TV field intensity meters; audio & RF generators; harmonic distortion meters; impedance bridges; IM meters; log printers; multitest systems; phase meters; status & alarm indicators; voltmeters; multimeters, dB meters; wow & flutter meters VS
See ad pg 145

POWER-OPTICS INC

1055 W Germantown Pike Fairview Village PA 19409

215 539-5300

Video camera stabilizing systems; remote control camera mounts; monitor calibrators; animation production equip rentals

PROCART

7012 27 St W Tacoma WA 98466
206 565-4546

Audio cartridges VS

VS MEANS IT'S VERIFIED

PRODELIN INC

PO Box 131 Hightstown NJ 08520
609 448-2800

VHF & UHF antennas; flexible & rigid transmission line; transmission line connectors; microwave antennas, reflectors, waveguides; satellite antennas

PROJECTION SYSTEMS INC

66 Clinton Rd Fairfield NJ 07006
201 575-9166

TV projection systems; large screen projectors

PROTECH AUDIO CORP

PO Box 638 15 Gail Drive Lake Ronkonkoma NY 11779

516 473-5979

Audio preamps, line, monitor, power & dist amps, amp power supplies; slide attenuators; ALC & AGC amps; AM & FM compressor/limiters; mechanical reverb units; audio consoles (portable, mono & stereo studio multi-output, audio for TV); hardwired intercoms VS

PTS ELECTRONICS INC

PO Box 272 5233 Hwy 37S Bloomington IN 47401
812 824-9331

TV field intensity meters; post-production service; hum bucking coils; tools

PULSE TECHNIQUES INC (PULTEC)

1411 Palisade Ave Teaneck NJ 07666
201 837-2575

Parametric equalizers & filters VS

PWH ELECTRONICS LTD

637 College St Toronto Ontario M6G 1B6
416 533-6331

Remote control systems; digital & master clocks, timers, time distribution systems; complete radio automation systems; radio & TV computer business services

PYRAMID INDUSTRIES INC

PO Box 23169 Phoenix AZ 85063
602 269-6431

Coaxial cable, cable connectors

Q

QEI CORP

Rte 73 Kresson NJ 08053

609 767-8052

AM, FM, stereo modulation monitors; FM exciters; average & peak maximizers; ATS systems; RF amps; receivers; FM transmitters; stereo generators; SCA generators; AM & FM compressor/limiters; SCA monitors VS
See ad pg 148

QRK BROADCAST ELECTRONICS

PO Box 3606 Quincy IL 62301

217 224-9600

Consoles (mixers, mono, stereo, audio for TV, portable); disc consoles; patch panels; turntables; pickup arms; turntable preamps & controls; speed controls; speakers; studio cabinets & furniture; audio amps (line, preamps, monitor); reverb units; digital clocks VS

QSI SYSTEMS INC

993 Watertown St W Newton MA 02165
617 969-7118

Logging recorders; small production switchers; video identification systems; time lapse video action recorders; digital clocks; master & slave clocks; tape loggers; timers; RF demodulators; time code gens/readers; sync gen systems; alphanumeric gens; video dist amps VS

Q-TV/TELESYNC

33 W 60 St New York NY 10023
212 765-4200

TV prompter systems VS

QUAD EIGHT ELECTRONICS CORP

11929 Vose St N Hollywood CA 91605
213 764-1516

Audio preamps, line, monitor & power amps; FM compressor/limiter filters; parametric & graphic equalizers & filters; delay systems & mechanical reverb units; complete automation systems; audio consoles (stereo studio multi-output, automated); VU meters & LED audio level indicators VS

QUANTUM AUDIO LABS

1909 Riverside Dr Glendale CA 91201
213 841-0970

Audio consoles (portable, audio for TV, studio stereo multi-output); reverb units VS

QUICK-SET INC

3650 Woodhead Or Northbrook Il 60062
312 498-0700

Video camera heads, tripods, pedestal & dollies VS

THE CHOICE IS YOURS!

THE AUDIOPAK A-2 OR THE STEREO PHASED AA-3 BROADCAST CARTRIDGE

Capitol Audiopak Broadcast Cartridges—
for stations who care how they sound.

Both Audiopak carts offer extremely low wow and flutter; a positive brake system which stops the tape, not the hub, assuring accurate cueing. Unsurpassed reliability is assured because we manufacture the tape and all other components in the cartridge. Moreover, all carts are 100% tested before shipping.

The AA-3 offers excellent stereo phase stability. It's loaded with Capitol's own Q17 HOLN tape which extends frequency response and headroom to provide studio sound quality.

CAPITOL MAGNETIC PRODUCTS
A Division of Capitol Records, Inc.
6902 Sunset Blvd.
Hollywood, California 90028

SEE US AT NRBA BOOTH 523



©1980 CAPITOL RECORDS, INC

Circle 181 on Reader Service Card

QUINTEK INC
 4721 Laurel Canyon Blvd St 209 N Hollywood CA
 91607
 213 980-5717

Graphic equalizers & filters; audio delay systems;
 audio special effects; SMPTE time code system;
 SMPTE readers, generators & reader/generators;
 auto locators; acoustic screens & wall panels VS

R

RADIOMETER ELECTRONICS US INC
 795 Sharon Dr Cleveland OH 44145
 216 871-7617

Audio & RF generators; harmonic distortion meters;
 wow & flutter meters VS

RADIO SYSTEMS
 5131 W Chester Pike Edgemont PA 19028
 215 356-4700

Audio preamps, monitor & power amps; RF carrier
 current; facility turnkey installation; radio studio
 design VS

RADMAR INC
 1282 Old Skokie Rd Highland Pk IL 60035
 312 831-9000

16 mm film telecine projectors & multiplexers; film
 processors VS

RAINBO PRODUCTS
 404 N River Ypsilanti MI 48197
 313 482-6591

Manual lighting control systems; gooseneck lamps
 VS

RAMKO RESEARCH INC
 11355 A Folsom Blvd Rancho Cordova CA 95670
 916 635-3600

Audio distribution, line, preamp, monitor amps; ALC
 & AGC amps; LED audio level indicators; mono,
 stereo, audio for TV, portable, mixing consoles;
 turntables, turntable preamps & controls; speakers;

single, dual, multiple cassette & cartridge
 player/recorders; open-reel studio
 player/recorders; digital clocks & timers VS

See ads pgs 28-29, 154-155—refer to rep/dist section

RANGERTONE RESEARCH INC
 509 Madison Ave New York NY 10022
 212 753-5430

Magnetic film recording equipment; film transports;
 telecine systems; 16 mm & 35 mm film projectors;
 slide projectors

RANK CINTEL — See Strand Century

RANK PRECISION IND INC
 411 E Jarvis Ave Des Plaines IL 60018
 312 297-7720

Video & film camera lenses and accessories;
 Varotol lens repair service VS

RAVEN SCREEN CORP
 124 E 124 St New York NY 10035
 212 534-8408

Front & rear projection screens

RCA AMERICAN COMMUNICATIONS INC
 400 College Rd E Princeton NJ 08540
 609 734-4200

Satellite transmission services; post-production
 services VS

RCA BROADCAST SYSTEMS
 Front & Cooper St Bldg 2-2A Camden NJ 08102
 609 338-3000

Audio preamps, monitor, power & dist amps; ALC &
 AGC amps; AM & FM compressor/limiters; audio
 consoles (portable, mono & stereo studio
 multi-output, audio for TV); open-reel studio tape
 player/recorders; quad videocassette cart players;
 color studio cameras; ENG EFP cameras; RGB
 chroma keyers; color correctors; color encoders;
 dropout compensators; SMPTE time code readers,
 generators & reader/generators; helical capstan
 servo TBCs; two-VTR editor/controllers;
 multi-source video editors; computerized auto

assembly editors; VTRs (quad, one-inch helical);
 new VTR heads; head refurbishing; machine
 rebuilding; magnetic recording equip & accessories;
 AM, FM, VHF & UHF transmitters; two-way radio
 communications; AM & FM antennas; HP & CP TV
 antennas; facility turnkey installation; mobile van
 construction VS

See ad pg 30

AL	B Fincher 2244 Center Point Rd Suite 208 Birmingham 35223	205 854-3096
CA	C Shaw 330 Primrose Rd Suite 305 Burlingame 94010	415 343-2741
	R Lyons Suite 531 6363 Sunset Blvd Hollywood 90028	213 468-4087
CO	J Butts 777 S Wadsworth Blvd Iron Gate IV Lakewood 80226	303 986-1521
FL	R Giles 3900 RCA Blvd Palm Beach Gardens W Palm Beach 33410	305 622-1100
GA	J Kelly 3395 NE Expy RCA Bldg Atlanta 30341	404 455-3400
IL	F Timberlake 1120 W Eastman St Suite 303 Arlington Hts 60004	312 255-2202
IN	J Ayers 9240 N Meridian St Suite 102 Indianapolis 46260	317 267-6395
KS	E Ray 5750 West 95th St Suite III Overland Park 66207	913 642-3185
MA	P Taylor 40 William St Wellesley Office Pk Wellesley 02181	617 237-6050
MI	G Schmidt 16400 W Twelve Mile Rd Suite 215 Southfield 48076	313 569-5880
MN	DG Schulte 4601 Excelsior Blvd Suite 305 Minneapolis 55416	612 920-6395
MO	W Marlin 7701 Noah's Ark Suite 340 St Charles 63301	314 946-7755
NC	C Patterson 1515 Mockingbird Ln Suite 211 Charlotte 28209	704 525-4870
NJ	N Hudak Front & Cooper Sts Eldg 2-2 Camden 08102	609 963-8000
NY	T Moore 500 S Salina St Suite 214 Syracuse 13202	315 478-4195
	R Varda 1180 Ave of the Americas 22nd Flr New York 10036	212 930-4651
OH	W Barrington 11430 Hamilton Ave Cincinnati 45231	513 825-1550
PA	C Koriwchak 761 N Washington Rd McMurray 15317	412 941-5570
TX	B Laughlin 3409 Executive Ctr Dr Suite 213 Austin 78731	512 345-2224

Ask for
 fiberoptics by name.

The Source '80

E Hoff 8700 Stemmons Freeway Dallas
75247 214 638-6820
VA R Parkhill 1901 North Moore St Arlington
22209 703 558-4233
WA L Pinski 1818 Westlake Ave N Suite 222
Seattle 98109 206 285-2375
WI R Yokes Grafton State Bank Bldg
Suite 403 101 Falls Rd Grafton
53204 414 377-8430

VS MEANS IT'S VERIFIED

RCA DIST & SPECIAL PRODUCTS DIV
2000 Clements Bridge Rd Deptford NJ 08096
609 541-3636

Camera pickup tubes; FM & HP TV antennas;
transmission line & connectors: RF tubes VS

RCA ELECTRO OPTICS & DEVICES
New Holland Ave Lancaster PA 17604
717 397-7661

Camera pickup tubes: vacuum tubes VS

RCA SERVICE CO
Dept 2615 Bldg 204-2 Rt 38 Cherry Hill NJ 08358
609 338-3000

Videotape duplicating service: live & film camera
installation & service. TV tape. TV antenna
measurement installation & service: teleproduction
system design & implementation VS

R-COLUMBIA PRODUCTS CO INC
2008 St Johns Ave Highland Park IL 60035
312 432-7915

Headphones: RF & hardwired intercom systems;
dynamic & condenser electret mics VS

**RECORDING SUPPLY CORP — See Polyline
Corp**

RECORTEC INC
475 Ellis St Mt View CA 94043
415 962-0220

Audio and video tape cleaners, cleaning and
evaluating services: videotape rewinders & timers:
VTR players/recorders (segmented-helical, helical
cassette, automated systems): U-type VCRs, VTR
machine rebuilding VS

See ad pg 167—refer to rep/dist section

REDDING RADIO DIV SJ INDS INC
Box 344 Fairfield CT 06430
914 561-4769

Call letter plates: telephone coupling equip VS

REGISTER DATA SYSTEMS
PO Box 1246 Perry GA 31069
912 987-2501

Radio business computer services equip VS

RE-PLAY VIDEO CARTRIDGE SERVICE
328 Merritt Ave Pittsburgh PA 15227
412 881-9172

Videotape cartridge reloading service VS

RESEARCH SYSTEMS TECHNOLOGY INC
33447 Kelly Rd Fraser Mi 48026
313 296-1540

19-inch equip racks: amp power supplies: audio line
& preamps: graphic equalizers & fillers: studio
stereo & mono multi-output consoles VS

RESEARCH TECHNOLOGY INC
4700 Chase Lincolnwood IL 60646
312 677-3000

Film cleaning & evaluating systems: film editing
equipment: videotape storage

REVOX—See Studer-Revox

REX RHEOSTAT AND CO INC
149 Babylon Turnpike Roosevelt LI NY 11575
516 379-1030

AM dummy antennas VS

REYNOLDS/LETERON CO
6704 Valjean Van Nuys CA 91406
213 994-1194

Character generators VS

**RF SYSTEMS INC — See Comtech Antenna
Corp**

RF TECHNOLOGY INC
60 Wilton Rd Westport CT 06880
203 226-6181

Wireless mics: microwave equip (intercity, portable,
ENG, airborne): RF amps: microwave STLs VS

RHG ELECTRONICS LABORATORY INC
161 E Industry Court Deer Park NY 11023
516 242-1100

Demodulators: ENG & airborne microwave equip:
modulators, comm. & monitor receivers: RF
attenuators: microwave STLs

RICHMOND SOUND DESIGN LTD
2963 W 27 Ave Vancouver BC V6L 1W4
604 734-5462

Full line audio mixing consoles: audio preamps: line
& dist amps: amp power supplies: graphic
equalizers & filters VS

RIPLEY CO INC
46 Nooks Hill Rd Cromwell CT 06416
203 635-2200

Tools VS

RIVERS ASSOCIATES INC
Box 58 Leominster MA 01453
617 537-4821

Intercom systems, tone detection devices, audio
silence alarm, SCA equip, program subcarrier, EBS
two-tone systems: two-way digital telemetry

RKO TAPE CORP
3 Fairfield Crs W Caldwell NJ 07006
201 575-8484

Audio tape, open-reel and cassettes: tape
duplicators VS

Choose from two new recording electronics packages from Inovonics.



Model 380 is the upgraded successor to our well-known 375, used in hundreds of studios and stations around the world. With your tape transport and our 380, you have the ultimate analog recorder. Features of the 380 include:

- Advanced circuitry to reduce the effects of tape compression and phase distortions.
- Unprecedented signal and bias headroom for

full compatibility with highest-coercivity tapes.

- Two "workhorse" EQ and bias settings, plus an optimized mode with separate setup for best performance from "super" tapes.
- Compatibility with virtually any combination of transports and heads.
- SYNC reproduce and exclusive auto-mute.
- Remote control of all functions.

The perfect pair.

Use the 380 to create new, ultimate-performance recording equipment, or to give your old tape or mag-film recorder a sound so clean you must hear it to believe it. \$820.00

Model 370 is intended for routine replacement use. It is compatible with most studio transports and a wide variety of original and replacement heads. The 370 will make "new" machines out of your older studio recorders, delivering superior performance and great reliability. \$580.00

For more information, see your distributor or contact us today.

Inovonics Inc.

503-B Vandell Way
Campbell, CA 95008

Telephone
(408) 374-8300



Circle 182 on Reader Service Card

RMS ELECTRONICS INC
50 Antin Place Bronx NY 10462
212 892-6700

Audio & video dist. amps; dynamic mics; VTR head cleaners; FM antennas; HP TV antennas; transmission line & connectors; audio connectors **VS**

ROCKLAND SYSTEMS CORP — See Wavetek Rockland Inc

ROCKWELL INTERNATIONAL CORPORATION
COLLINS TRANSMISSION SYSTEMS DIV
1200 N Alma Rd Richardson TX 75081
214 996-5000

Intercity and portable microwave equipment; receivers; comm and monitor; satellite earth stations **VS**
See ad pg 43

CA	A Mora 898 Chestnut St Redwood City 94063.....	415 365-3364
CO	R Hammond 11846 W Ratcliff Ave Morrison 80465.....	303 978-9600
CT	J Sedik 100 Hemlock Dr Killingworth 06417.....	203 663-2571
FL	H Smith 1300 Executive Center Dr Tallahassee 32302.....	904 877-2580
GA	Atlanta.....	404 979-0888
MN	R Milner 5200 W 73 St Minneapolis 55435.....	612 835-4989
MO	D Mehl 11004 E 40 Hwy Independence 64055.....	816 737-3033
OH	V Hedges 3950 SR 309 Galion 44833.....	419 468-3964
SC	W Sampson 459 Plantation Rd Rock Hill 29730.....	803 366-7428
TX	F Bearden PO Box 10462 Dallas 75207.....	214 996-6456
VA	T Pruett 1745 Jefferson Davis Hwy Arlington 22202.....	703 685-2661

RODELCO ELECTRONICS CORP
365A Comac Rd Deer Park NY 11729
516 643-5110
 TV & FM translators

ROH CORPORATION
4313 NE Expressway Atlanta GA 30340
404 939-2622

Audio preamps, line, monitor & distribution amps, audio routing switchers; attenuators; intercom systems **VS**

ROHDE & SCHWARZ SALES CO (USA) INC
14 Gloria Ln Fairfield NJ 07006
201 575-0750

Speakers; b&w & color monitors; sync generator systems (sync, color bar, black burst, stairstep/ramp, multiburst); comb decoders; RF demodulators; modulators; VHF transmitters; AM, FM & TV field intensity meters; RF generators; video generators (multiple output, cross pulse); video noise meters; video test generators; VITS; VIR systems & equip **VS**
See ad pgs 13, 184—refer to rep/dist section

ROSCO LABORATORIES INC
36 Bush Ave Port Chester NY 10573
914 937-1300

Lighting heads, stands, fixtures; diffusion material, gels and filters; set design; lens cleaning tissue

ROSNER TELEVISION SYSTEMS INC
250 West 57 St New York NY 10019
212 246-3967

Radio & TV studio design; facility turnkey installation **VS**

ROSS VIDEO LTD
Iroquois Shopping Center Iroquois ON K0E 1K0
613 652-4889

Large & small production switchers; master control switchers **VS**

RTS SYSTEMS
1100 W Chestnut St Burbank CA 91506
213 843-7022

Audio preamps, line & dist amps; mic mixers & portable audio consoles; hardwired intercoms; telephone coupling equip **VS**

RUSLANG CORP
247 Ash St Bridgeport CT 06605
203 384-1266

Freestanding & table-top consoles for audio & video equip; 19-inch equipment racks; cabinets & furniture **VS**

RUSSCO ELECTRONICS MFG INC
5690 E Shields Ave Fresno CA 93727
209 291-5591

Audio dist, power amps; preamps; audio consoles (mono, portable, studio); turntables, remote pickup equipment **VS**

S

SACRED SOUNDS
11635 Richmond St Riverside CA 92505
714 785-4567

Syndicated radio programming services **VS**

SADELCO INC
75 West Forest Ave Englewood NJ 07631
201 569-3323

Field intensity meters for TV calibrators **VS**

SAE (SCIENTIFIC AUDIO ELECTRONICS INC)
701 E Macy St Los Angeles CA 90012
213 489-7600

Audio preamps & line amps; parametric equalizers & filters; audio delay systems; headphones **VS**

SAKI MAGNETICS INC
5770 Uplander Way Culver City CA 90230
213 649-5983

Audio and video magnetic tape heads, new and refurbished; VTR head refurbishing **VS**

SANSUI ELECTRONICS CORP
1250 Valleybrook Ave Lyndhurst NJ 07071
201 460-9710

Audio preamps, monitor & power amps; parametric & graphic equalizers & filters; mechanical reverb

Ask for fiberoptics by name. Then expect some advantages that no one else can offer you.

Only Valtec has a field-proven baseband video/audio/data fiberoptics system. Our economical alternative to coaxial or microwave is immune to hum, ground loop or RFI problems. So you can

Valtec.



best with every other. You also get the full benefit of Valtec's 13 years of fiberoptics experience.

So ask for fiberoptics by name. And send for our free brochure. Valtec Corporation, Communication Fiberoptics, West Boylston, MA 01583. (617) 835-6082. Telex: 92-0355.



enjoy noise-free transmission up to three kilometers without using costly repeaters or equalizers. And modular design makes installation and system expansion easy and fast. Individual video, audio and data cards plug easily into a compact 19" equipment shelf. You decide how many channels of each you need for your

broadcasting or CATV trunking application.

Whether you communicate video, voice or data, Valtec's total manufacturing integration is important, too. We make it all—glass, fibers, cables, systems, light sources, electro-optic interfaces. As a single source, we make sure every component in your system works



Circle 183 on Reader Service Card

The Source '80

units; portable audio consoles, turntables; dynamic & condenser/electret mics; mic stands, booms & dollies; speakers; VU meters VS

SAWYER CAMERA CO
6820 Santa Monica Blvd Los Angeles CA 90038
213 466-6111
TV studio design; post-production equip rental; stage rental

SCALA ELECTRONIC CORP
PO Box 4580 Medford OR 97501
503 779-6500
Communications antennas; FM antennas; STL microwave antennas; HP TV antennas VS

KEN SCHAFFER GROUP INC
10 E 49 St New York NY 10017
212 371-2335
Audio special effects, reverb units, delay lines; digital broadcast delay for obscenity deletion; intercom systems; wireless mics; audio spectrum analyzers; duplex wireless com systems VS

VS MEANS IT'S VERIFIED

SCHNEIDER CORP OF AMERICA
185 Willis Ave Mineola NY 11501
516 747-5100
Video camera lenses; motion picture camera lenses; lens accessories; lenses for slide projectors, 16 mm, 35 mm motion picture projectors VS
See ad pg 182

SCIENTIFIC-ATLANTA
3845 Pleasantdale Rd Atlanta GA 30340
404 449-2000
Transmit/receive, receive-only satellite earth stations VS

SCIENTIFIC RADIO SYSTEMS INC
367 Orchard St Rochester NY 14606
716 458-3733
FM transmitters, RF receivers, comm & monitor; audio power amps; HF receivers & transceivers; VHF & AM transmitters & receivers

SCIENTIFIC SYSTEMS INC
92 Westwood Dr Toms River NJ 08753
201 255-2230
Audio distribution amps

HH SCOTT INC
20 Commerce Way Woburn MA 01888
617 933-8800
Audio analyzers; audio cassette player/recorders

SCOTT INSTRUMENTS LABORATORIES
13 Sagmore Pk Rd Hudson NH
603 880-6300
Sound level meters

L J SCULLY MANUFACTURING CORP
138 Hurd Ave Bridgeport CT 06604
203 368-2332
Tape deck reproducers, disc cutting equip

SCULLY RECORDING INSTRUMENTS — See Ampro/Scully

SEACOR INC
123 Woodlawn Ave Westwood NJ 07675
201 666-5600
Capacitors

SENCORE INC
3200 Sencore Dr Sioux Falls SD 57107
605 339-0100
Field intensity meters; sweep generators for VHF, UHF, FM, & chroma; field effect meters; dual-trace oscilloscopes; AM/FM stereo analyzer; power supplies; voltmeters, multimeters, oscilloscopes; frequency monitors & counters; automatic TV monitors; transistor testers

SENNHEISER ELECTRONIC CORP
10 W 37 St New York NY 10018
212 239-0190
Mics (dynamic, condenser/electret, wireless, shotgun, lavalier); booms, stands & dollies; mic accessories; headphones VS

SEQUERRA CO
132-60 34 Ave Jamaica NY 11435
212 297-5000
Broadcast monitor; FM intensity meters, modulation monitors

SESCOM INC
1111 Las Vegas Blvd Las Vegas NV 89101
702 384-0993
Audio preamps, line & dist amps; rotary & slide attenuators; AM & FM compressor/limiters; parametric & graphic equalizers; audio generators VS

SETCOM CORP
1400 Stierlin Rd Mountain View CA 94043
415 965-8020
Headsets & communications accessories

SFENA CORP
26 17 Aviation Pky Grand Prairie TX 75051
214 988-8000
Camera stabilizing systems VS

SGL WABER ELECTRIC
300 Harvard Ave Westville NJ 08093
609 456-5400
Plugs and connectors, multiple outlet electrical fixtures, utility carts

SHALLCO INC
Smithfield Ind Pk S PO Box 1089 Smithfield NC 27577
919 934-3135
Audio rotary attenuators

Spanning the globe

*to provide expert engineering consultation.
And significant savings on equipment purchases.*

Throughout the U.S. Across Canada. In any country on any continent. Global Communications & Engineering stands ready to deliver innovative engineering consultation, turnkey services and complete systems installation at all types of communications facilities. From point-to-point single sideband systems to satellite earth stations. From medium-wave broadcasting to complex TV installations. Whatever the job, anywhere on earth, *The Problem-Solvers* at GC&E are ready to handle the assignment with precision and reliability. And save you money in the process.

- **Antenna System Design and Installation.** AM, FM, TV, Satellite Earth Station, medium wave and shortwave.
- **Transmitter System Design and Installation.** TV, AM, FM, Medium and Shortwave, Satellite Earth Station.
- **Studio Systems.** Complete radio and TV studio systems services, including video switching, audio mixing, studio design, studio turnkey packages, in PAL, SECAM, and NTSC.
- **Custom Engineering and Complete System Consultation.** Total design services, from the ground up or modification and renovation.

The engineering staff at GC&E is backed by vast international experience on major network assignments. And now, GC&E has developed a flexible pricing/discount program designed to offer substantial savings on equipment purchases.

For unparalleled engineering expertise and lower equipment costs, too, call in the GC&E *Problem-Solvers* today. Anywhere in the world is as close as your telephone or telex.

TELEPHONE: (203) 261-2068 or (203) 261-8638 TWX: 710 450 3641
Members: IEEE • SMPTE • SBE



GLOBAL

COMMUNICATIONS & ENGINEERING, INC.

914 WHITE PLAINS RD., TRUMBULL, CT 06611

Circle 184 on Reader Service Card

The links where quality is never missing.



Regardless of whether your programs originate from another city, a local sporting event, or an ENG assignment, your video transmission links have to maintain the same high quality standards. Day in and day out.

No manufacturer of video transmission equipment is more aware of that fact than Farinon Video. That's why we offer the finest lines of microwave radios, receivers, and related video transmission equipment available.

STL and Intercity Relay Links

- FV-F Series Heterodyne Microwave Radios provide almost transparent signal transmission in all available spectrum allocations worldwide.
- FV40 Transmission Equipment provides extreme flexibility for conditioning video and audio signals applied to any transmission medium.
- FV43 Audio Transmission Channel System allows simultaneous transmission of high fidelity mono or stereo sound with the video signal.

Remote Pick-Up Links

- FV-P Series Portable Microwave Radios offer frequency agility, fingertip tuning and rugged construction.

ENG Links

- FV-MP Series Miniature Portable Microwave Radios are extremely lightweight, compact, and completely self-contained.
- FV-MF Series Miniature Microwave Radio Transmitters provide a high degree of flexibility for airborne or vehicular installation.
- FV-CR Series Central Receivers feature synthesized channel selection, unsurpassed dynamic range, superior selectivity, and excellent inherent RFI protection.

We also offer a variety of ancillary equipment, including low-noise preamplifiers, power amplifiers, and portable test units.

You can depend on Farinon Video for transmission links where quality is never missing. Call or write HARRIS CORPORATION, Farinon Video, 1680 Bayport Avenue, San Carlos, CA 94070; (415) 595-3500; Telex 34-8491. In Canada, 657 Orly Avenue, Dorval, PQ H9P 1G1; (514) 636-0974; Telex 05-82-1893.



HARRIS
COMMUNICATION AND
INFORMATION PROCESSING

Circle 185 on Reader Service Card



Bell Helicopter **TEXTRON**
Commercial Helicopters

A Bell JetRanger III puts you on top of the competition, giving you an edge in audience share.

Get a big story on the early news instead of the late night edition and you have a tremendous competitive advantage. If the viewer watches the early telecast, you stand a good chance to hold him all evening. And that means rating points!

The best way to beat the competition is with a Bell JetRanger III. It gets you into otherwise inaccessible areas. It lets you transmit live up to 120 miles away, or tape and transmit enroute. The story can be on the air before you land.

Bell's JetRanger III is a superior ENG platform, offering low noise and vibration, so you get sharper pictures and cleaner audio. The large cabin allows shooting from either side through large sliding windows. And there's no need to clutter the space, because there's plenty of storage room in the baggage compartment, as well as in other accessible storage areas.

Bell's JetRanger III. Backed by the world's most extensive parts and service system.

Would you like to see what one can do for you?

For more information on Bell helicopters designed for the communications industry, contact Bell Helicopter Textron, Department 698, Box 482, Fort Worth, Texas 76101, or call 817/280-2117.

Circle 186 on Reader Service Card

www.americanradiohistory.com

The Source '80

SHAREPOINT SYSTEMS INC
402 Tenth Ave Haddon Heights NJ 08035
609 546-1841

Hardwired intercoms; audio cart machine controller/timers; tape timers; electronic tape editors; RF program subcarriers; FM processors; receivers, comm & monitor; remote control systems; remote pickup equip; FM SCA equip; digital clocks; master & slave clocks; timers; time distribution systems; facility turnkey installation; radio studio design **VS**

SHARP ELECTRONICS CORP
10 Keystone Place Box 588 Paramus NJ 07652
201 265-5600

Audio power amps; turntables; speakers; cassette tape player/recorders; studio cameras; studio/field convertible cameras; ENG EFP cameras; mono cameras; lenses & accessories; color monitors; SEGs; sync, color bar & black burst generators; helical cassette VTRs **VS**

SHINTRON CO INC
144 Rogers St Cambridge MA 02142
617 491-8700

Video moduline consoles; production switchers. SEGs; sync generator systems (sync, color bar, black burst); character generators; alphanumeric generators; video pulse & subcarrier amps; encoded & luminance chroma keyers; time code gens readers; audio dist. amps **VS**

See ad pg 177

SHIVELY LABS INC
Rt 302 Raymond ME 04071
207 655-3841

TV & FM antennas; transmission line & connectors; diplexers; patch panels **VS**

SHURE BROTHERS INC
222 Hartrey Ave Evanston IL 60204
312 866-2200

Audio preamps, monitor & power amps; FM compressor/limiter filters; parametric equalizers & filters; audio consoles (mic mixers, portable, studio stereo multi-output); phono pickup arms & cartridges; mics (dynamic, condenser/electret, ribbon, lavalier); mic stands, booms & dollies; speakers; telephone coupling equip **VS**

See ad pg 189—Call or write main office for nearest rep

SIEGEL ELECTRONICS
PO Box 33421 San Diego CA 92103
714 295-4995

Video processing amps with image enhancement, color correction **VS**

SIEMENS CORP
186 S Wood Ave Iselin NJ 08830
201 494-1000

Gas-filled surge voltage lighting protectors for cable amps & power supplies

SIGMA ELECTRONICS INC
1830 State St E Petersburg PA 17520
717 569-2681

Video amps (pulse, distribution, subcarrier); sync & black burst generators; sync pulse changeover; audio dist amps; passive video switchers; video processing amps with auto color black

SIMPAC INTERNATIONAL INC
5472 Kenilworth Dr Huntington Beach CA
92649
714 846-0765

Storage systems for carts

SINGER EDUCATION SYSTEMS
3750 Monroe Ave Rochester NY 14603
716 586-2020

16 mm projectors; slide projectors; filmstrip projectors; sound slide projectors/viewers

SINGER PRODUCTS CO INC
875 Merrick Ave Westbury NY 11590
516 333-2000

Transmitters AM & FM; FM antennas; studio equip

VS MEANS IT'S VERIFIED

THE NETWORKS' CHOICE. (AND EVERYONE ELSE'S.)

At Camera Mart, we've been a leading equipment supplier to broadcasters and producers for years. We're no strangers to the 'instant' needs, unexpected calls, tough standards and difficult operating conditions that are often S.O.P. in this rough-and-tumble business. But you probably know that...at least, when it comes to film.

What you may *not* know is, for the past few years, we've been quietly doing the same in *video!* Testing and selecting the leading equipment for performance and reliability. And offering a wide selection of production and post-production components and packages—on rental, lease and purchase plans with our customary flexibility.

But don't take our word for it: talk to our customers. You'll see why so many people the industry depends on, depend on us.



Camera Mart

THE CAMERA MART, INC.
456 West 55th Street, New York 10019
(212) 757-6977/Telex: 1-2078
Sales • Service • Rental



Circle 187 on Reader Service Card

"On-Board" Frezzi™ Battery Packs™



**for any
video camera.**

Reliable, high-capacity, O.E.M. or replacements for Hitachi, Ikegami, Philips, RCA, Sony and others. Less than 1 hour re-charge time with "Frezzi-Fast"™ Chargers.

Model FBP-13 4A
direct-mounted
to back of Ikegami
HL 79A camera

**Frezzi™
Engineering
builds portable power
for ANY system.**

**"Frezzi-Lite™"
Portable Camera Lights**
for video/TV & film/ciné

**Choice of 100w, 150w, 250w, 350w.
Removable dichroic filter.**

For Hand-held use, Lightstand mounting, or film and video camera mounting.

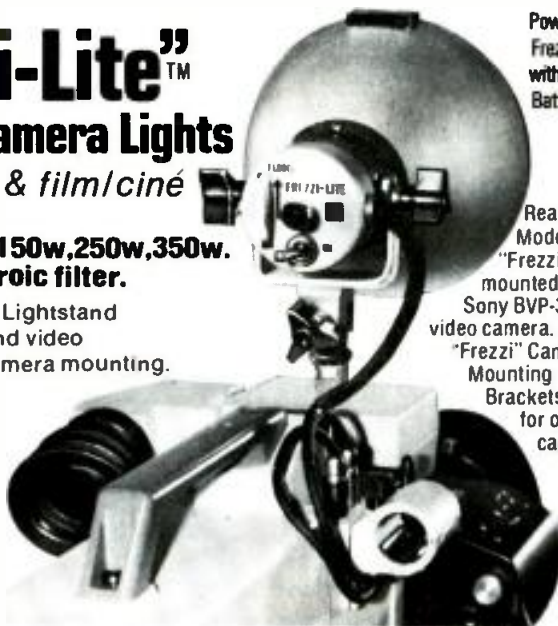

Power
Frezzi-Lites™
with "Frezzi"
Battery Packs.

Rear view of
Model FL-250
"Frezzi-Lite"
mounted on a
Sony BVP-300
video camera. Other
"Frezzi" Camera
Mounting
Brackets made
for other
cameras.

For information call (N.J. 201) 427-1160 (N.Y.C. 212) 594-2294

MADE
IN U.S.A.



Frezzolini Electronics Inc.
7 Valley St. Hawthorne, N.J. 07506 USA

Export Agents:  11 Caesar Place, Moonachie, N.J. 07074 U.S.A. • (201) 939-0875
Telex: Cinecraft Moon TLX 13-8865 • Cables: Cinecraft Moonachie

The Source '80

SUPERIOR ELECTRIC CO
383 Middle St Bristol CT 06010
203 582-9561

Lighting control systems (manual, automated, dimmer packs); electrical connectors: surge protectors; transformers; voltage conditioning equip; voltage regulators **VS**

SUPERSCOPE INC
20525 Northoff Chatsworth CA 91311
213 998-9333

Condenser mics; cassette decks; receivers; turners; preamps; loud speakers; turntables; tape player/recorders; equalizers; car stereo

SURCOM ASSOCIATES
305 Wisconsin Ave Oceanside CA 92054
714 722-6162

Vacuum capacitors, mica capacitors **VS**

SWAGER TOWER CORP
PO Box 656 Fremont IN 46737
219 495-5165

Lamps; AM, FM, microwave & HP antennas; towers **VS**

SWINTEK ENTERPRISES INC
1180 Aster Ave Sunnyvale CA 94086
408 249-5646

RF intercom systems; wireless mics; remote pickup equip; FM transmitters; two-way radio communications **VS**

See ad pg 201

SWITCHCRAFT INC
5555 N Elston Chicago IL 60630
312 792-2700

Audio connectors **VS**

SWR INC
PO Box 215 Goffstown NH 03045
603 497-3000

Transmission line & accessories; RF cable & connectors; TV antennas **VS**

SYNTON ELECTRONICS BV
c/o Parasound Inc 680 Beach St San Francisco CA 94109
415 673-4544

Vocoders **VS**

SYRACUSE SCENERY & STAGE LIGHTING CO
1423 N Salina St Syracuse NY 13208
315 474-2474

Seamless materials; grids, tracks & curtains **VS**

SYSTEM CONCEPTS INC
395 Ironwood Dr Salt Lake City UT 84115
801 486-3833

Character generators/filters; newsroom computers **VS**

See ad pg 107

OH Eastern office 16006 Waterloo Rd
Cleveland 44110 216 692-3410
OK Southwest 8345 E 5th Pl Tulsa
74112 918 838-0931

SYSTEMS MARKETING CORP—See Sono-Mag Corp

SYSTRON DONNER
2750 Systron Or Concord CA 94518
415 682-6161

Digital clocks, time distribution systems; frequency monitors & counters; RF generators; voltmeters, multimeters, dB meters; multitest systems; microwave equipment components; SMPTE time code generators readers **VS**

SYSTRON OONNER CORP MICROWAVE OIV
14844 Oxnard St Van Nuys CA 91409
213 786-1760

Microwave instruments systems, subsystems & components; sweep generators & test sets **VS**

VS MEANS IT'S VERIFIED



Lenco wants you to take a closer look at your Master Control Monitor.

A true master control monitor, the 519 and all of its major functions can be remoted, letting you stay put in the director's chair. Resolution is 625 lines or more. And it's the only broadcast monitor with two NTSC inputs plus RGB.

For years broadcasters have been accustomed to having one or two manufacturers supply their master control monitors. Lately, however, these suppliers have allowed their tube technology to lag. And they've been slow in solving the problems of ever-lengthening delivery times and fast-rising costs.

Lenco, long a leader in monochrome broadcast monitors, is doing something about the situation. We've taken a totally fresh approach. Setting the pace in master control monitor technology is our new PrecisionMaster 519 Color Monitor.

Consider the 519's precision in-line tube, for years the accepted standard in demanding European broadcast applications. The pictures it produces can even surpass Delta tube pictures. Watch the traditional color monitor suppliers adopt this approach—eventually.

Convergence is a thing of the past. There are no electronic convergence controls. PrecisionMaster Monitors are set for life at the factory. And that means 24 fewer jobs for you to perform during set-up. Adding to its operational ease is one-button control for color balancing.

The best is still to come. Built in the U.S., the 519, or larger model 522, are both available for 30-day delivery and cost about \$1,000 less than traditional monitors.

Times have changed. Maybe it's time for you to take a closer look at your master control monitors, and at Lenco PrecisionMaster Monitors.

Lenco, Inc., Electronics Division,
300 N. Maryland St., Jackson, MO 63755.
(314) 243-3147.



The Name to Watch
in Color Monitors



Circle 191 on Reader Service Card

OUR SATs BRING YOU A NEW SPECTRUM IN PROGRAMMING

The California Microwave Small Aperture Terminal (SAT) can make you a superstation in your market. From world news to stereo disco and the MET, the broadcast networks using satellite technology pioneered by California Microwave will deliver a new spectrum of program diversity and quality right to your local studio. And that means delivering audience, economically, anywhere in the country. Our modular SAT assures you unmatched flexibility at a surprisingly low cost with features such as these:

- Greater than 70 dB audio dynamic range
- Impeccable stereo delivery nationwide
- Cue, automation, hard copy, and wire service data channels
- Multiple channels per carrier (MCPC) for regional sports

The SAT that has set the standard for the broadcast networks and wire services is available now.



**KDFM
& KKIS**

**CALIFORNIA
MICROWAVE**

CALIFORNIA MICROWAVE, INC.

880 Almenor Ave. Sunnyvale, Calif. 94086

(408) 732-4000 TWX 910 339-9231

Call Jim Smith Ext. 163

Circle 194 on Reader Service Card

The Source '80

T

TA (TRACK AUDIO INC) — See Applied Technology

TABER MFG & ENG CO
2081 Edison St San Leandro CA 94577
415 635-3831

Replacement audio heads for VTR & audio recorder/players; audio & VTR bulk erasers; VTR head refurbishing, replacement & rebuilt videotape heads **VS**

TANDBERG OF AMERICA INC
Labriola Court Armonk NY 10504
914 273-9150

Open reel recorder/players; cassette recorder/players; speakers; monitor amps & receivers

TANGENT SYSTEMS INC THE PHOENIX GROUP
2810 S 24 St Phoenix AZ 85034
502 267-0653

Audio preamps, line, monitor & power amps; amp power supplies; parametric equalizers & filters; full line audio consoles; intercom talkback modules; patch panels; SMPTE time code synchronizing system; SMPTE readers, gens & reader/gens; VU, PPM & LED level indicators; dB meters; post-production equip rentals; facility turnkey installation; mobile van construction; audio post-production services; radio & TV studio design **VS**

TAPCO (TECHNICAL AUDIO PRODUCTS CORP)
3810 148 Ave NE Redmond WA 98052
206 883-3510

Audio power amps; active equalizers and filters; reverb units; audio consoles (mono, stereo); speakers

TAPECASTER TCM INC
PO Box 662 Rockville MD 20851
301 881-8888

Tape cartridge equip; audio carts

TAPEX CORP
228 Fifth St Suite 2 W Des Moines IA 50265
515 274-3087

Audio tape carts, cassettes, test tapes; empty reels, carts, cassettes; leader tape; tension gauges; alignment gauges; replacement tape heads; head degaussers; bulk erasers; tape storage

TAYBURN ELECTRONICS
6106 Avenida Encinas Carlsbad CA 92008
714 438-5444

Microwave systems (intercity, portable, ENG, airborne); microwave supports & portable equipment; remote control systems; tower hardware & construction equip **VS**

TDK ELECTRONICS
755 Eastgate Blvd Garden City NY 11530
516 746-0880

Open-reel, cartridge, cassette, pancake, test audio tape; videotape; videotape cleaners **VS**

TEAC CORP OF AMERICA
7733 Telegraph Rd Montebello CA 90640
213 726-0303

Audio preamps, amp power supplies; graphic equalizers & filters; mics (dynamic, condenser/electret); noise reduction systems; open-reel studio tape player/recorders; head degaussers; VU meters **VS**

TECH ELECTRONICS INC
1000 Peachtree Rd NE Atlanta GA 30341
404 455-7626

Videotape editing controller

TECH LABORATORIES INC
Bergen & Edsall Blvds Palisades Pk NJ 07650
201 944-2221

Rotary & slide attenuators **VS**

D.C. Servo Drive Runs Smooth Steady Cool

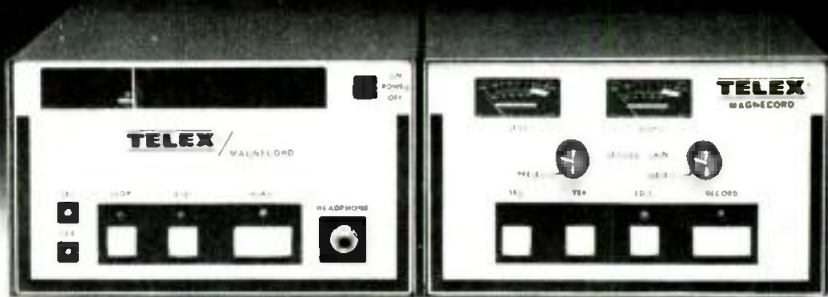

Of course, it's Telex/Magnecord

Telex Magnecord broadcast cart machines run cool and steady. So cool no ventilation is required, so steady not even voltage or frequency fluctuations will alter their speed. Thanks to our dc servo flutter-filter drive. Completely immune to RFI and EMI, it meets or exceeds all NAB standards and is suited for local or remote/automated operation.

Standard features at no extra cost.

- An edit pushbutton to add stop cues in playback and omit stop cues in record
- LED indicators show end of tape, status and secondary/tertiary cue tones
- Front panel headphone jack
- VU meters for each channel

Convenient, Flexible

MC-Series is field convertible from mono to stereo, or play to record. Optional remote controls simply plug in.

Four broadcast cart machines to choose from in the Telex/Magnecord MC-Series - all made in U.S.A. and affordable. Write for detailed information.

Quality products for the audio professional



9600 ALDRICH AVE. SO., MINNEAPOLIS, MN 55420 U.S.A.
Telephone 612-884-4051, telex 29-7053

EUROPE: 22, rue de la Légion-d'Honneur, 93200 St. Denis, France. Téléphone: 820-98-46, telex 63-0013
CANADA: Telak Electronics, Ltd., 100 Midwest Road, Scarborough, Ontario M1P3B1, Telephone: 416-752-8575

Circle 193 on Reader Service Card

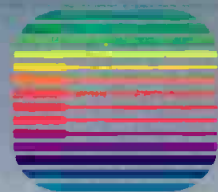

INNER VIEW 2: A closer look at Conrac Monitors

Matched Phosphors: Different screens, same shade.

There's nothing magical about how we achieve the same picture on several Conrac monitors. Hue for hue, shade for shade, the colors are an exact match.

Conrac achieves this color reproducibility with its Colormatch™ picture tube. A precision-made CRT whose screen phosphors are closely controlled to fall within ± 0.005 tolerance of specific chromaticity coordinates (as measured on the CIE colorimetry chart).

And, since every Conrac Colormatch™ phosphor CRT adheres to this CIE standard, the subtle color tones you get on one monitor will be precisely duplicated on every Conrac monitor with a Colormatch™ phosphor CRT.

Correct color reproduction: Conrac precision at work.

Conrac's precision decoder delivers an accuracy of 2%, as measured on NTSC color bar test signals. This assures you that the color signal in each Conrac monitor is being properly separated and controlled.

Conrac's picture quality comes from a number of engineering advances.

One of these is demodulator output filtering. Tunable filters allow precision alignment of the sharpness of the color demodulation signals. Result: crisp, clear color separation with no

ringing, preshoot or overshoot distortions.

There's also Conrac's highly accurate decoder. If the decoder is inaccurate (illustration), the blue color bars will be unequal in amplitude and produce shade differences as seen on the color bar display.

Conrac's decoder, on the other hand, is precisely aligned to produce color bars of equal amplitude and shading.

Conrac Technology: Over thirty years of leadership.

Conrac's track record of technical innovation stretches back more than three decades.

And what we've learned since then goes into every monitor we make today. That's important to you. Because the more technology we pack into each monitor, the more performance you'll receive from it.

Matched phosphors and color stability are just two ways Conrac technology can save you time and money.

For the complete inner view of Conrac technology, call or write us today: Conrac Division, Conrac Corporation, 600 North Rimsdale Ave., Covina, CA 91722, Telephone: (213) 966-3511, Telex: 67-0437.

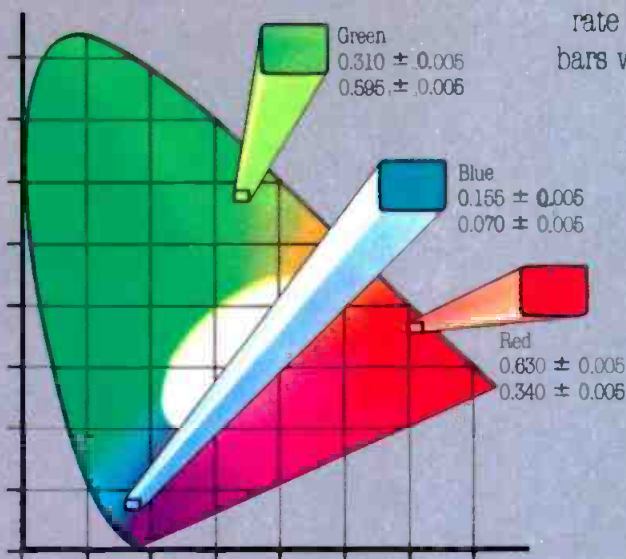

Conrac ensures a ± 0.005 tolerance for their CRT phosphors.

Oscilloscope waveforms show how Conrac achieves color quality by ensuring precise demodulator phase separation.

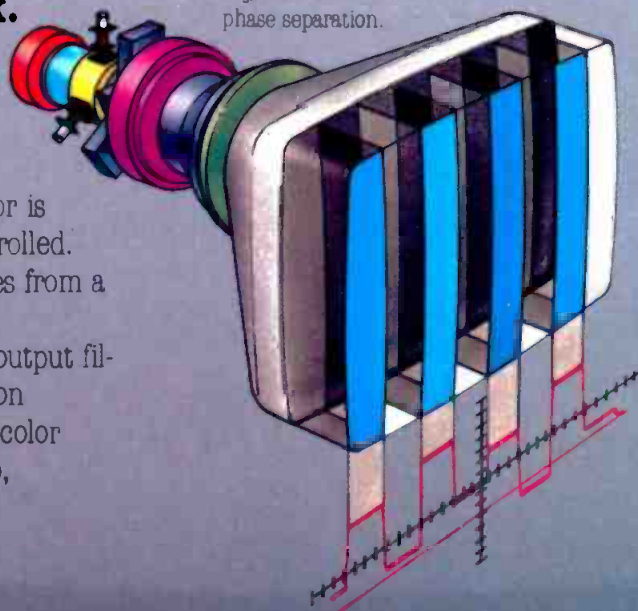

Quality you can take for granted.

The Source '80

TECHNICAL AUDIO PRODUCTS CORP — See Tapco

TECHNICS BY PANASONIC
One Panasonic Way Secaucus NJ 07094
201 348-7000

Turntables; direct-drive tape decks; cassette players; preamps; power amps; equalizers; mics; peak average meters; speakers **VS**

TECHNISPHERE CORP
215 E 27 St New York NY 10016
212 889-9170

Equip rental & sales; post-production services; electronics design services; repair services

TECHNOLOGY SERVICE CORP
2950 31 St Santa Monica CA 90405
213 450-9755

Weather radar systems

TEKTRONIX INC
PO Box 500 Beaverton OR 97077
503 644-0161

Oscilloscopes; color picture monitors; spectrum analyzers; demodulators; sideband analyzers; video test generators; sync; color bar; black burst; staircase/ramp; multiburst generators; audio generators; voltmeters; multimeters; VITS & VIR systems & equip; diff phase gain measurement; vectorscopes; video processing amps; logic analyzers; video noise meters; dB meters; waveform monitors & analyzers; automated test & measured systems; PPM & LED audio level indicators; frequency monitors & counters; multitest systems; video noise meters. **VS**

TELAUTOGRAPH CORP
8700 Bellanca Ave Los Angeles CA 90045
213 641-3690
RF facsimile equip

TELE-CINE INC
5434 Merrick Rd Massapequa NY 11758
516 798-2828

Film and TV lenses and accessories (Schneider); camera stabilizing systems **VS**

TELECTRO SYSTEMS CORP
9618 43 Ave Corona NY 11368
212 651-8900

Speakers; audio tape (open-reel, carts & cassettes); single & dual cart players/recorders; tape duplicators; tape loggers **VS**

TELEDYNE BIG BEAM
290 East Prairie Crystal Lake IL 60014
815 459-6100
Emergency lighting

TELEDYNE CAMERA SYSTEMS
131 N 5 Ave Arcadia CA 91006
213 359-6691
Video to film recording systems; optical equip

TELEDYNE ENERGY SYSTEMS
110 W Timonium Rd Timonium MD 21093
301 252-8220

Power supplies for remote applications

TELEMATION — See Fernseh Inc.

TELE-MEASUREMENTS INC
145 Main Ave Clifton NJ 07014
201 473-8822

TV camera alignment slides for b/w & color; TV slide light boxes; TV equip rental/repair; studio/van design

Spot Check.



The Dictaphone 4000 Logger, a complete broadcast recording-retrieval system, is the answer to a radio station's need to know. And show.

Now, from one dependable unit, you get an automatic, around-the-clock record of all essential broadcast information. It's all there, ready for quick retrieval and replay. So if advertisers want proof that their commercials are running on schedule or if the FCC wants to check your station breaks or public service announcements, you've got it all. On the record.

 **Dictaphone**

A Pitney Bowes Company

For more information on the 4000 Logger, fill in this coupon or call toll-free:

800-431-1708

Except in Hawaii and Alaska
(In New York call 914-967-1300)

JBME — 90

Name _____ Title _____

Department _____ Phone _____

Address _____

City _____ State _____ Zip _____

Mail to: Dictaphone Corp., 105 Oak St., Norwood, N.J. 07648

Dictaphone is a trademark of Dictaphone Corp. Rye, N.Y.



Here's \$3,990.50 worth of great news... from the originators of low cost, high performance microprocessor video editing systems.

Introducing the:



The EA-3x is not designed to be the least expensive editing system on the market. What it represents, however, is an extremely potent editing system that simply does it all. It works handily with all popular 1/2" and 3/4" VTRs: No modifications necessary.

One example of the advanced microprocessor technology developed by Cezar International, LTD., is Micro-loc.* Micro-loc* totally eliminates the need for SMPTE time code... actually it is an improvement. It doesn't require a \$2,000 SMPTE reader. It doesn't tie-up an audio channel. Micro-loc* format already is hard at work in over 150 editing systems.

Compare EA-3x Features

- | | |
|--|--|
| <ul style="list-style-type: none"> <input type="checkbox"/> Variable shuttle arm control of tape speeds <input type="checkbox"/> Edits may be rehearsed, performed and reviewed <input type="checkbox"/> Interchangeable VTR formats <input type="checkbox"/> Independent control of audio and video channels <input type="checkbox"/> High speed search to any specific frame on the tape (That's the potency of Micro-loc*) | <ul style="list-style-type: none"> <input type="checkbox"/> Selects in or out points on-the-fly <input type="checkbox"/> No CRT required. Display is totally self contained <input type="checkbox"/> Programmable pre- and post-rolls <input type="checkbox"/> Full VTR remote control <input type="checkbox"/> Auto tag with recall <input type="checkbox"/> Control track (With or without Micro-loc*) plus optional SMPTE |
| <ul style="list-style-type: none"> <input checked="" type="checkbox"/> Cruise capability <input checked="" type="checkbox"/> Pre-roll cue <input checked="" type="checkbox"/> Numeric trim of ins and outs <input checked="" type="checkbox"/> Optional fade "up from/down to" black | <ul style="list-style-type: none"> <input checked="" type="checkbox"/> Optional "Perfect Pitch"... eliminates the Donald Duck effect <p>And a little built-in personalized feature we especially appreciate:</p> <ul style="list-style-type: none"> <input checked="" type="checkbox"/> Numeric brightness control (DIM) of all lamps and displays. |

Afterthought: Actually, when you consider all the features of the EA-3x... at \$3,990.50, it may indeed be the least expensive editing system around. How about a demo? Contact us or the best distributor in your area. Chances are he's one of ours.

"The Originators"

*Micro-loc. Patent Pending.
Cezar International LTD.

Cezar International, LTD.

491 Macara Avenue, Sunnyvale, CA 94086 Tel: (408) 733-1436
Circle 196 on Reader Service Card

The Source '80

TELEMET

185 Dixon Ave Amityville NY 11701
516 842-2300

Audio monitor, power & dist amps; RGB & encoded chroma keyers; small production switchers; video pulse & dist amps; routing switchers; signal equalizing systems; sync generator systems (sync, color bar, stairstep/ramp, multiburst); demodulators; modulators; optical fiber STLs; diff phase-gain measurement; sideband analyzers; spectrum analyzers; video test generators; VITS, VIR systems & equip VS

See ad pg 165 — refer to rep/dist section

NY B Griffiths RFD #3 Brewster
10509..... 914 279-3231

TELESCRIPT INC

20 Insley St Demarest NJ 07627
201 567-2220

Teleprompters VS

TELESTRATOR — See Interad

TELEVISION ENGINEERING CORP

580 Goddard Ave Chesterfield MO 63207
314 532-4700

Facility turnkey installation; mobile van construction; TV studio design VS

TELEVISION EQUIPMENT ASSOCIATES (TEA)

Box 260 S Salem NY 10590
914 763-8893

Headphones; intercom systems; RF & hardwired; dynamic mics; audio & video tape cleaners; videotape rewinder; video delay lines & filters; video equalizer; tape cleaning & evaluating; tape rewinders; color monitor comparator; videotape evaluators; VITS, VIR systems & equipment; monitor calibrator VS

See ad pgs 148, 186, 199—refer to rep/dist section

TELEVISION GRAPHICS

555 Broad St Glen Rock NJ 07452
201 444-2911

Post-production equipment rental

TELEVISION PRODUCTION SERVICES CORP

381 Horizon Dr Edison NJ 08817
201 287-3626

Set design; equipment rental; pre-production consultation

TELEVISION PRODUCTS CO INC

9016 Aviation Blvd Inglewood CA 90301
213 776-3276

Camera pedestals; mic booms & perambulators VS

TELEVISION TECHNOLOGY CORP

5970 W 60 Ave Arvada CO 80003
303 423-1652

RF amps, attenuators, convertors, filters; FM & TV translators; diplexers VS

See ad pg 186

TELEX COMMUNICATIONS INC

9600 Aldrich Ave S Minneapolis MN 55420
612 884-4051

Audio preamps; relay & time insertion sequencers; headphones; hardwired intercoms; dynamic & lavalier mics; empty audio carts; single cart player/recorders; open-reel tape player/recorders (portable, studio, logging); tape duplicators; communications antennas; tape loggers VS

See ad pg 135—refer to rep/dist section

TELONIC/BERKELEY

PO Box 277 Laguna Beach CA 92652
714 494-9401

Test instruments; RF attenuators; sweep generators, RF filters, microwave sub-systems; impedance bridges; dB meters

TENNAPLEX SYSTEMS LTD

34 Bentley Ave Ottawa ONT K2E6T8
613 226-5870

Diplexers; ENG microwave equip; TV combiners; communications, antennas; HP & CPTV antennas; impedance bridges; antenna pattern service for TV & FM computers VS

ARVIN/ECHO: Innovation in Intelligent Video Production Equipment.

Arvin/Echo is a division of the Arvin Applied Technology Group, one of the most comprehensive and prestigious private research and development companies in the world. As a technological leader, Arvin/Echo has built its reputation on producing rugged, reliable broadcast production equipment.

EFS-1A: The EFS-1A offers the industry an extraordinary Frame-Stor™ Recorder in a small package (38 pounds). It is also available in PAL/SECAM. The relative low cost of the EFS-1A enables broadcasters to install a system in news, production or wherever the capability is required. The unit uses Arvin's unique, flexible Discassette® which electronically stores 400 slides (200 per side), is virtually indestructible, and is interchangeable with any EFS-1A System in the world. Remote random access to the EFS-1A System is also available with an optional interface to character generators.



SLO/MO™-1: Another use for the Arvin/Echo Discassette principle is the capability to provide the instant replays which are expected by sports fans. The SLO/MO-1 is a versatile production tool which is light weight, rugged, transportable and sells for a reasonable price. The system gives broadcasters capabilities such as slow motion, freeze/frame select and time saving editing. SLO/MO's usefulness in sports, news and commercials is enhanced by its High Band Color, Digital Comb Filter, Digital Time Base Correction and Digital Field Storage.



SS-2 Slide-Stor™ System: The SS-2 System is replacing 35mm slides as the medium for still presentations because it greatly simplifies the production and storage of graphics. All graphics can be preprogrammed on disc for instant call-up during broadcast. The SS-2 System frees a camera during the show, and eliminates the need for expensive tele-cine chains. Vertical/interval switching for on air use from one disc to another is built in. At the heart of the SS-2 System are two EFS-1A Broadcast color Discassette Frame-Stor Recorders which together will store up to 400 NTSC, or 200 PAL/SECAM high quality television frames—on line. Add more Discassettes for access to unlimited images.



THE IMAGE MAKER (EFS-2)®: All the advantages of our EFS-1A and much, much more. The Image Maker is a compact, versatile, programmable unit which delivers random access to 500 images on line with our exclusive Discassette. Preview and program outputs are built in. It also has the capability to do sequences and motion loops from 16 frames to 500 frames. Record and playback in single frame, real time, or anything in between for exciting animation effects. Serial digital interface is standard.

THE SQUEEZER™: A unique and highly affordable production tool which can reduce images to four discrete sizes ($1/4$, $1/9$, $1/16$, and $1/25$ of original) with complete positioning capabilities. Squeeze stills or live video. Border the image with full color which can be adjusted for width, saturation and hue. Then use the border to crop from one of the four sizes to infinity. Or, leave the border off entirely. It's your choice. The Squeezer can also insert one image into itself or key it over another. Signals for down stream keying are provided. And, it can be preset to four positions before air time.

Contact Dennis Shelton, Marketing Director at

ARVIN/ECHO™ 485 E. Middlefield Road, Mountain View, California, 94043
Telephone: (415) 961-7145, TWX: (910) 379-6499

Circle 197 on Reader Service Card

APPLIED
TECHNOLOGY
GROUP
ATG
ARVIN

Why can't an Audio Mixer be more like a Video Switcher

Presenting an Audio system that's

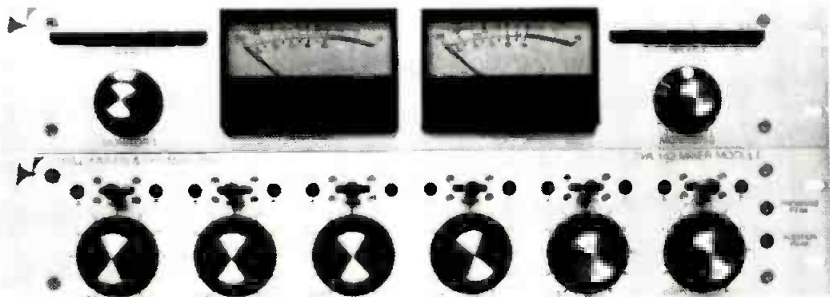

- Configured like a Video Switcher.
- Has Audio Follow Video features.
- Dual Channel mixing capability.
- All Inputs both Mic and Line level.
- Expandable to 36 Inputs.
- Optional Speaker amps and muting.



Hallikainen and Friends

101 Suburban, San Luis Obispo, CA 93401 (805) 541-0200

Circle 198 on Reader Service Card

TOMCAT
CARTRIDGE SYSTEM EXCELLENCE

PACIFIC RECORDERS & ENGINEERING CORP.
11100 Roselle St., San Diego, CA 92121 (714) 453-3255

Circle 199 on Reader Service Card

The Source '80

TENDEL CORP

50 Curtner Ave Cambell CA 95008
408 377-6588

Tape tension gauges; timers; elapsed time; spindle height gauges VS

See ad pg 21

TEPCO CORP

PO Box 680 Rapid City SD 57701
605 343-7200

TV & FM translators; FM boosters; comm. & monitor receivers; microwave equip

TERRACOM DIV OF LORAL CORP

9020 Balboa Ave San Diego CA 92123
714 278-4100

Microwave STLs; microwave relay, portable, mobile. ENG microwave radios & antennas; receive-only satellite earth stations; digital audio program channel multiplexers VS

TEXAS ELECTRONICS INC

PO Box 7225 Inwood Sta Dallas TX 75209
214 631-2490

Meteorological monitoring equip

TEXSCAN CORP

2446 N Shadeland Ave Indianapolis IN 46219
317 357-8781

Rotary attenuators; RF attenuators & filters; automated test & measurement systems; impedance bridges; oscilloscopes; spectrum analyzers VS

TEXWIPE

650 Crescent Ave Upper Saddle River NJ 07458
201 327-5577

Head & tape cleaning. VTR video head cleaners VS

THALNER ELECTRONIC LABS

7235 Jackson Rd Ann Arbor MI 48103
313 761-4506

Character generators; 2-way & 4-way video screen splitters; video ID systems; video time/date generators; video counters, timers; portable video timing equip

THEATRE TECHNIQUES INC

60 Connelly Pkwy Hamden CT 06514
203 281-6111

Audio mixers; intercom systems; manual & automatic light dimmer controls; patch terminals VS

THERMODYNE INTL LTD

12600 Yukon Ave Hawthorne CA 90250
213 679-0411

Film cases; video equipment carrying cases VS

THOMSON-CSF ELECTRON TUBES

750 Bloomfield Ave Clifton NJ 07015
201 779-1004

RF power tubes, vacuum tubes, UHF/VHF tetrodes & circuits, UHF klystron VS

THOMSON-CSF BROADCAST INC

37 Brownhouse Rd Stamford CT 06902
203 327-7700

Audio dist amps; AM & FM compressor/limiters; color studio cameras; ENG/EFP cameras; digital video noise reducers; character generators; image enhancers; frame synchronizers; helical capstan servo TBCs VS

See ad pg 61

CA	M Clayton 1919 W Magnolia Blvd Burbank 91506.....	213 849-2188
GA	F Benson 107 Tulipree Ter Peachtree City 30269.....	404 487-6756
IL	T Lorenzen 7644 Rae Ln Gurnee 60031.....	312 356-6924
TX	M McGreevy PO Box 905 Alient 77411.....	713 933-1700
VA	A Audick 8519 Buckboard Dr Alexandria 22308.....	202 296-9189

THOMSON-CSF LGT DIV

75 Rockefeller Plaza New York NY 10019
212 977-2214

TV translators: UHF & VHF transmitters VS

VS MEANS IT'S VERIFIED

If Their Edit Controllers Have You Searching for..

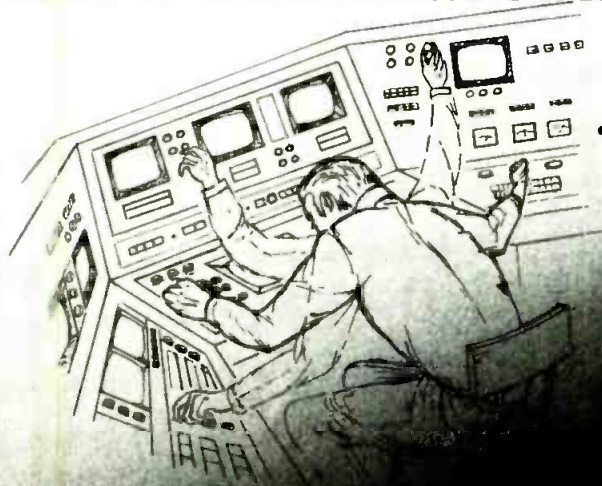

SUPER EDITOR

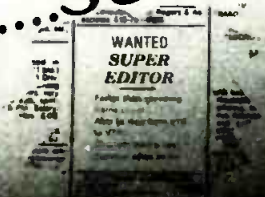

TRY OURS!!

Make your job easier! You have enough to do without fighting an edit controller.

We make a complete line of editing equipment at very competitive prices. From the "go-anywhere" RES-Q STAND ALONE to the "grow anywhere" RES-Q II system controller — we make it easier for you!

Have full-featured editingat your fingertips. If you are thinking about buying editing equipment and don't try ours, then we'll both lose! You'll lose valuable budget dollars and extra features.

Let us give you an on-site demonstration of how much easier your job can be!

Contact us at:

**1392 Borregas Avenue
Sunnyvale, CA 94086
(408) 734-0163**



UNEMCO INTERNATIONAL INCORPORATED



**Model shown is the
NM-1 NEWSMAKER Product No. 5001
Latest introduction into the EMS product line.**

Circle 200 on Reader Service Card

Join the ENG/EFP Double Standard



With the convenient PORTA-FLECTOR™ Double Standard, you can: 1. Wash those raccoon eyes out of standupper shots • 2. Keep the camera balanced in constantly changing light • Side 1—Soft-focus, strongly directional light reflector • Side 2—Matte white camera balance and peak white reference • Two sizes for 4-chart system, ENG systems case or VCR case. • Available from stock.

- | | | |
|---------|--|---------|
| #019-10 | PORTA-FLECTOR™ Double Standard, 12"x15" | \$65.00 |
| #019-11 | PORTA-FLECTOR™ Double Standard, 9½"x12½" | \$55.00 |

PORTA-PATTERN®

TELECOMMUNICATIONS INDUSTRIES LIMITED

6822 Santa Monica Boulevard Los Angeles, California 90038 U S A Telephone (213) 461-3561

Circle 201 on Reader Service Card

In UHF the biggest and the best is... BOGNER®

This minute there are more Bogner UHF slot antennas operating than any other make. The reason is simple. At every power range our patented slot array design has proven superior in every way: PICTURE QUALITY, RANGE, DURABILITY and (not least) ECONOMY.

Don't just take our word. Call Len King and he'll give you the names of Bogner purchasers so you can check it out yourself.

Bogner Broadcast Equipment Corp.

401 Railroad Avenue, Westbury, N.Y. 11590
Tel: (516) 997-7800

Circle 202 on Reader Service Card

The Source '80

THOR ELECTRONICS CORP
321 Pennsylvania Ave Linden NJ 07036
201 486-3300
Power tubes & rectifiers

TIFFEN MFG CORP
90 Oser Ave Hauppauge NY 11787
516 273-2500
Filters optical effects attachments for cine & TV camera lenses; camera tripods and accessories; lens adapters **VS**

TIME & FREQUENCY TECHNOLOGY INC
3090 Oakmead Village Dr Santa Clara CA 95051
408 727-7272
Microwave STLs; remote control systems; data acquisition & logging systems; RF modulators; FM translators; program subcarriers; demodulators; field intensity meters (AM, FM, & TV); log printers; modulation monitors; status & alarm indicators; automatic TV monitors, calibrators **VS**
See ad pg 151—refer to rep/dist section
PA T Creighton 1355 Jeanette Way
Southampton 18966..... 215 322-8911

TIMES WIRE & CABLE CO
358 Hall Ave Wallingford CT 06492
800 243-6904
Cable & wire; fiber optics cables & links; CATV systems **VS**

TM SYSTEMS INC
25 Allen St Bridgeport CT 06604
203 366-4571
Line amps, amp power systems, VU meters, dB meters; conditioning equip

TOPAZ ELECTRONICS DIV
3855 Ruffin Rd San Diego CA 92123
714 279-0111
Transformers; power isolators **VS**

TORPEY CONTROLS & ENGINEERING LTD
2220 Midland Unit 98 Scarborough ONT Canada MIP3E6
416 298-7788
Computer/microprocessor automation controllers; complete automation systems; automated MC switchers; video source identification systems; automatic TV monitors; digital clocks, master slave clocks; time distribution systems

TOSHIBA CORP BROADCAST ELECTRONICS SYSTEMS DIV
292 Gibraltar Drive Sunnyvale CA 94086
408 734-9172
Color TV studio cameras; ENG/EFP portable TV cameras; portable field production switcher **VS**

TOWNSEND ASSOCIATES INC
PO Box 1122 Westfield MA 01085
413 562-5055
Demodulators, diplexers, exciters, RF amps; HV power supplies for TV transmitters, TV transmitters; vacuum contactors; TV transmitter maintenance service **VS**

TRANSIST-O-SOUND INC
728 Yosemite Dr Indianapolis IN 46217
317 897-1549
ALC and AGC amps; audio consoles (mic mixers, portable) **VS**

TRANS-LUX CORP
625 Madison Ave New York NY 10022
212 751-3110
Rear projection screens

TRANSTECTOR SYSTEMS
PO Box 11159 Zephyr Cove NV 89448
800 648-3387
Transient surge protectors

TREISE ENG INC
1941 First St San Fernando CA 91340
213 365-3124
Motion picture color and b/w film processors & film processor accessories

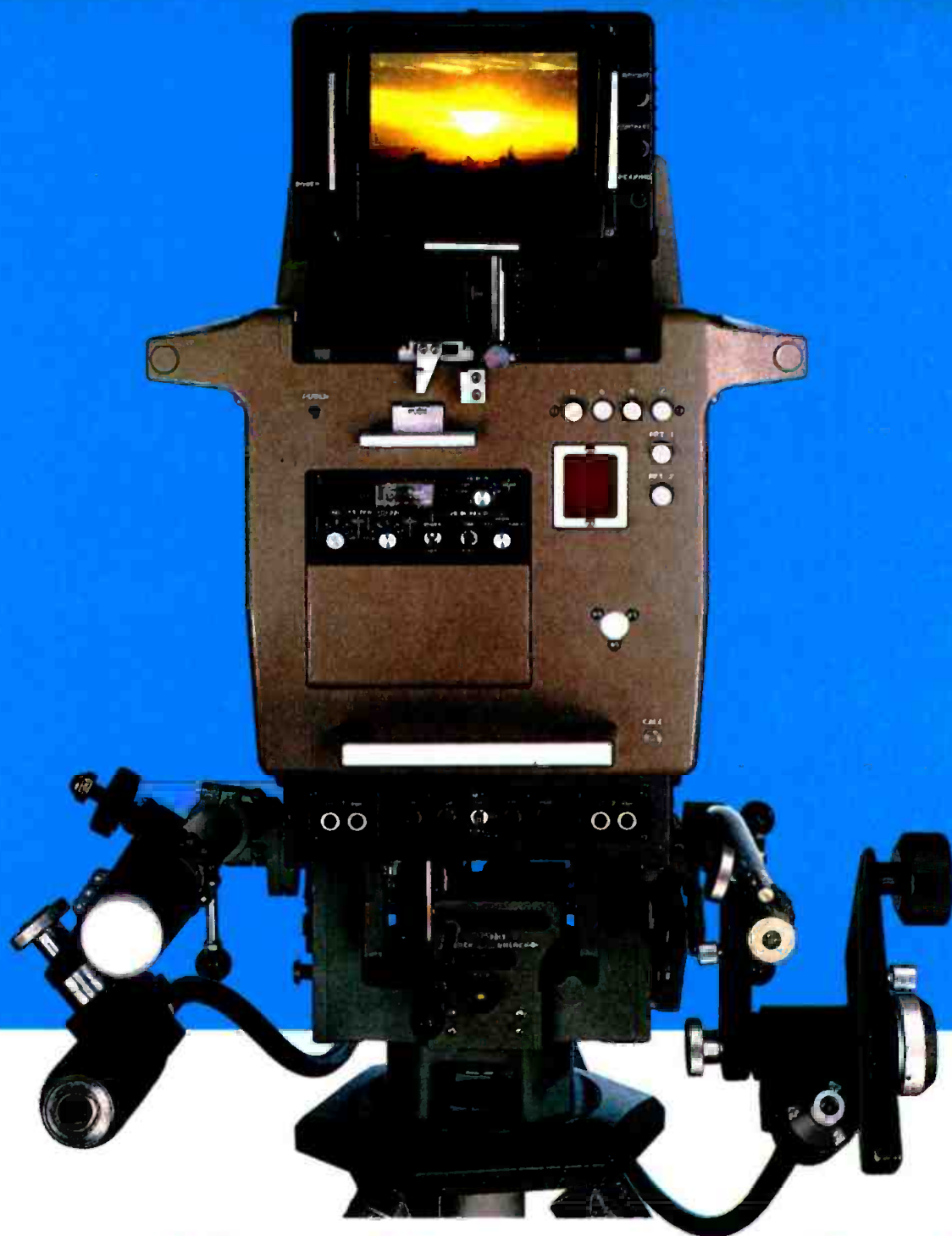

Ikegami has its eye on the 80's

In 1976, two pioneering ENG cameras revealed to a rapt world the shoot-from-the-shoulder delegate's view in color of the Democratic and Republican national conventions. Those two, the Ikegami HL-33 and the HL-35, soon became the ENG workhorses of the industry. The HL-77, Ikegami's first self-contained ENG camera, contributed to a major expansion in the use of ENG. And the current HL-79A, which opened up the era of the one-person ENG camera crew, has become the standard of the broadcast industry.

In 1977, Ikegami made a major contribution to the performance of studio cameras—the first microprocessor-controlled automatic-setup camera, the Ikegami HK-312. With hundreds of HK-312's now in use, Ikegami has expanded microprocessor control to its HK-357A field/studio and HL-53 EFP cameras.

Ikegami enters the 80's fresh from its triumphs at the Winter Olympics where 50 of its cameras contributed to the spectacular coverage of this event.

And while Ikegami enters the 80's

with a record of meaningful innovations and solid accomplishments during the last decade, what's most exciting are the products in the Ikegami engineering labs. So keep your eye on Ikegami. Ikegami Electronics (USA) Inc., 37 Brook Avenue, Maywood, N.J. 07607; (201) 368-9171. West Coast: 19164 Van Ness Ave., Torrance, CA 90501 (213) 328-2814; Southwest: 330 North Belt East, Suite 228, Houston, TX 77060 (713) 445-0100; Southeast: 552 South Lee St., Americus, GA 31709 (912) 924-0061.

Ikegami

Circle 203 on Reader Service Card

A FRESH APPROACH
to recording systems design...

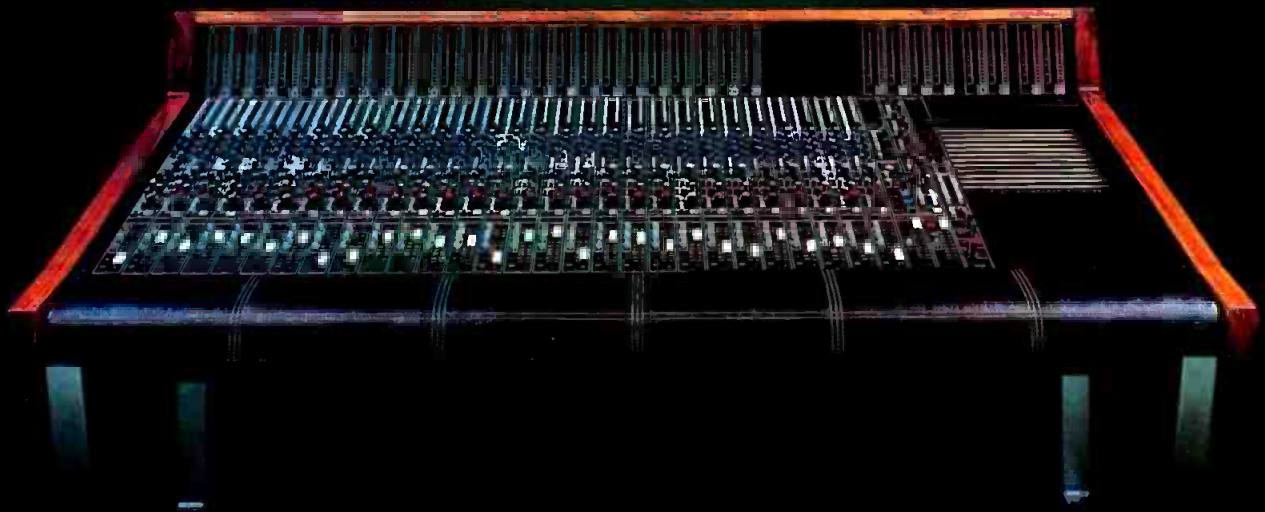

CONCERN/VISION-SOUND

Harrison /NO COMPROMISE

Vision-Sound is proud to represent the following manufacturers:

ACD	ELECTRO-VOICE	MONSTER NON-REACTIVE	SHURE
JOHN MEYERS	HARRISON RECORDING	MONITOR CABLE	SONY
ALLISON	SYSTEMS	MRL	STUDER PROFESSIONAL
BRYSTON AMPLIFIERS	IVIE ELECTRONICS	NEOTEK	RECORDERS
CALZONE CASES	KEITH MONKS AUDIO, LTD.	NORTHWEST SOUND	TECHNICS
DYNETIC ACOUSTICS	KOSS	ORANGE COUNTY ELECTRONICS	WEST PENN WIRE
EDCOR/CALREC	LOFT	SENNHEISER	WHITE INSTRUMENTS

VISION-SOUND PROFESSIONAL AUDIO • 110 GRAND AVENUE, ENGLEWOOD, N.J. 07631 • (201) 871-4101
toll-free/east of Ohio
(800) 526-4710

Circle 204 on Reader Service Card

The Source '80

TREPAC CORP OF AMERICA
30 W Hamilton Ave Englewood NJ 07631
201 567-3810

Audio/video automatic line program alarm; tone status reporting & control modules

TRI-EX TOWER CORP
7182 Rasmussen Ave Visalia CA 93277
209 625-9400

Self-supporting, guyed towers; portable towers

TRIPLETT CORP
1 Triplett Dr Bluffton OH 45817
419 358-5015

VU & dB meters; voltmeters; multimeters

TRI TEC SYSTEMS INC
1324 Motor Pky Hauppauge NY 11787
516 234-6090

Audio preamps; line, monitor & power & dist amps; parametric equalizers & filters; audio consoles (mono & stereo studio multi-output, audio for TV) VS

TRI-TRONICS INC
2921 W Alameda Burbank CA 91505
213 843-2170

Production equip rental, post-production services, studio design, radio and TV; mobile van construction, facility turnkey installation, color video monitor; video tape/film recording transfer

TROMPETER ELECTRONICS INC
8936 Comanche Ave Chatsworth CA 91311
213 882-1020

Audio patch panels; RF cables & connectors; audio; radio & electrical connectors; tools; wire & cable; custom cable assemblies; coax patching equip VS

TRUE TIME INSTRUMENTS DIV KINEMATICS
3243 Santa Rosa Ave Santa Rosa CA 95401
707 528-1230

Digital clocks; master & slave clocks; time distribution systems VS

ITE INC
2212 Barry Ave Los Angeles CA 90064
213 478-8224

Transformers; filters; capacitors; fixed film capacitors; RF, audio video filters; IM distortion measurement filters VS

TURNER — See Telex

TVNS
Suite 250R World Trade Ctr San Francisco CA 94111

415 982-3073
Newsroom computers VS

TWEED AUDIO INC
4545 #5E Industrial St Simi Valley CA 93063
213 394-5159

Audio amps (power & dist.); AM & FM compressor/limiters/filters; complete line audio consoles VS

2005AD INC
2005 Naudain St Philadelphia PA 19146
215 545-3488

Audio consoles, VU meters

U

UHF ASSOCIATES
90 Transport Ave Suite 4 Rohnert Pk CA 94928
707 584-7844

RF modulators VS

ULTRA AUDIO PIXTEC
BOX 921 Beverly Hills CA 90213
213 276-2726

Audio monitor, power & dist amps; audio consoles (mic mixers, portable, mono studio multi-output, audio for TV); lighting control systems (manual, automated, dimmer packs); remote pickup equip; vectorscopes; waveform monitors & analyzers; audio, video & film post-production services; radio & TV studio design VS

AGAIN & AGAIN POTOMAC INSTRUMENTS IS

PRODUCT INNOVATION
1ST

- First First** FCC Approved Antenna Monitor
- First First** Harmonic Reading Field Strength Meter for Standard Broadcast Stations
- First First** Digital Antenna Monitor
- First First** Frequency Synthesized RF Generator with Coherent Detector for RF Bridge Applications
- First First** Solid State Combination VHF Field Strength Meter and RF Generator
- First First** Audio Generator with these Features: L&R Outputs, Stereo Matrix Switch, IM Signal Source, Signal Leveling, Precision Attenuators, Mike and Line Source Impedance, Balanced and Unbalanced Outputs
- First First** Audio Analyzer with these Features: L&R Inputs, Auto Leveling and Auto Nulling THD Analyzer, IMD Analyzer, Wow and Flutter Meter, Stereo Phase Meter, Differential Gain Meter

CONTACT US NOW FOR DESCRIPTIVE LITERATURE ON OUR COMPLETE LINE OF BROADCAST INSTRUMENTATION.

POTOMAC INSTRUMENTS

932 PHILADELPHIA AVE.
SILVER SPRING, MD 20910
(301) 589-2662

Circle 205 on Reader Service Card

Video Delay Lines



ALLEN AVIONICS Video & Pulse Delay Lines replace 75 ohm coaxial cable, provide a more suitable method of achieving precise short delays. The units reduce size, weight, installation costs, and save time and effort in making delay changes.

- Finest Specs
- Lowest Pricing
- Delivery from Stock

Part No.	Delay Range (Nano-Sec.)	Delay Steps (Nano-Sec.)	Method of Variation	Maximum Insertion Loss @ 100 KHz (db)	Amplitude Flatness At Any Delay Setting 100KHz to 5.5MHz (db)	Max. Rise Time (Nano-Sec.)	Package Size (Inches)
VAR005	3-7	Continuous	Trimmer	.20	2 Max.	N.A.	3 1/2 x 1 1/2 x 1 1/2
VAR011	0-11	Continuous	Trimmer & Toggle	.20	25	N.A.	4 3/8 x 2 3/8 x 1 1/8
VP0010	0-10.5	5	Toggle	.15	.2	3	4 3/8 x 2 3/8 x 1 1/8
VP0127	0-127	1.0	Toggle	.15	.3	14	4 3/8 x 2 3/8 x 1 1/8
VP0255	0-255	1.0	Toggle	.15	.3	16	4 3/8 x 2 3/8 x 1 1/8
VP0317	0-317.5	2.5	Toggle	.15	.3	20	4 3/8 x 2 3/8 x 1 1/8
VP0635	0-635	5.0	Toggle	*.50	.4	25	4 11/16 x 3 1/16 x 2 1/16
VP1100	0-1100	10.0	Rotary	1.25	.4	30	4 11/16 x 3 1/16 x 2 1/16
VP1270	0-1270	10.0	Toggle	*3.00	.4	30	4 11/16 x 3 1/16 x 2 1/16
VP2075	0-2075	25.0	Toggle	*3.00	.5	40	7 3/8 x 4 11/16 x 3 1/16
VS0315	0-315	5.0	Strap	.25	.4	28	4 x 2 x 1 1/4
VS0635	0-635	5.0	Strap	.60	.5	33	5 x 2 x 1 1/4
VS1275	0-1275	5.0	Strap	1.25	.5	33	5 x 3 x 1 1/4
VS2075	0-2075	25.0	Strap	2.50	.5	40	6 1/2 x 3 1/2 x 2

Impedance: 75 ohms. *±.2db variation at any delay setting.

Pulse Distortion: Less than 4% with an input pulse rise time of 20 nanoseconds.

Working Voltage: 100 volts maximum.

Return Loss: 20db minimum. 15db minimum for VP2075 & VS2075.

Delay Tolerance: 5% or 1 nanosecond, whichever is greater.

VIDEO FILTERS: NTSC Lowpass, Band Reject & Bandpass are our specialties.

CALL/WRITE FOR VIDEO DELAY LINES & VIDEO FILTERS CATALOG

ALLEN AVIONICS, INC. 224 EAST SECOND ST., MINEOLA, NY 11501
Phone: 516-248-8080

Circle 206 on Reader Service Card

B/E SEPTEMBER, 1980 145

Quality... Side by Side



The TSM-5 Waveform Monitor and its companion, the new VM-5PR five inch color monitor, occupy only 5 1/4 inches of vertical rack space. Such professional features as A-B inputs, internal-external sync, tally light, keyed back porch clamping, RGB gun switches, and separate RGB background and drive controls make the VM-5PR an excellent monitor for ENG, mobile vans, or any application where space is at a premium. Available options include pulse cross and underscan.

QUALITY ENDURES AT
 **Videotek,
Incorporated**

125 N. York St., Pottstown, PA 19464 (215) 327-2292
 Branch Office
 9625 N. 21st Dr., Phoenix, AZ 85021 (602) 997-7523

Circle 207 on Reader Service Card

CLEAR-COM.[®] TAKE ONE.

When you have the best team you don't compromise on equipment. Our closed circuit intercom system is specifically designed to cut through high noise environments and deliver superior clarity under the most demanding conditions. Off-the-shelf standard products are always available and completely field serviceable. Our New System II with state-of-the-art electronics, allows up to 100



belt pack stations to be used on over 5 miles of standard mic cable or optional dry pair. The systems can also operate on 12 to 28 VDC battery packs.

Portable and permanent single or multi-channel wired systems are flexible and can interface with existing intercoms, TV cameras or telco lines.

For studio or remotes, depend on the professional standard of excellence, Clear-Com.

For further information contact:

 **Clear-Com**
intercom systems

759 Harrison Street, S.F., CA 94107, (415) 989-1130
 See us at Booth # 165, N.Y. S.M.P.T.E.

Circle 208 on Reader Service Card

The Source '80



UMC ELECTRONICS CO SENSTROL DIV
 460 Sackett Pt Rd North Haven CT 06473
 203 288-7731

Relay sequencers; computer/microprocessor controllers; multi-cart machines; complete automation systems; audio consoles (mixers, stereo, audio for TV); tape cart player recorders (single, dual, multiple); replacement tape heads; bulk erasers; head degaussers; tape cartridges VS
 See ad pg 150—refer to rep dist section

UNARCO-ROHN DIV OF ROHN IND INC
 PO Box 2000 Peoria IL 61656
 309 697-4400

Towers, hardware and construction equip: tower lighting VS

UNION CONNECTOR CO INC
 149 Babylon Tpk Roosevelt NY 11575
 516 623-7461

Lighting patch terminals; lighting plugs connectors; electrical connectors VS

UNI-SET
 449 Ave A Rochester NY 14621
 716 544-3820

Modular studio set design

UNITED MEDIA INC
 4075 Leaverton Ct Anaheim CA 92807
 714 630-8020

Two-VTR editor-controllers; computerized auto-assembly editors; multi-source editors; SMPTE time code readers, generators, reader generators VS
 See ad pg 114

UNITED RECORDING ELEC IND (UREI)
 8460 San Fernando Rd Sun Valley CA 91352
 213 767-1000

Audio line amps & pre-amps, amplifier power supplies; compressor limiters, AM & FM; active equalizers & filters; delay lines; mono, stereo, quad, audio for TV consoles; turntable pre-amps & controls; speakers; VU meters; chart recorders; audio generators; spectrum analyzer VS

UNITED RESEARCH LABS
 16 E 52 St New York NY 10021
 212 751-4663

Open-reel studio tape player recorders; record reproduce amps VS

UNITED SYSTEMS CORP (DIGITEC)
 918 Woodley Rd Dayton OH 45403
 513 254-6251

Frequency counters, counter-timers; digital clocks; digital voltmeters; frequency converters, frequency synthesizers; pulse, sine, square-wave generators; time base generators; status and alarm indicators

UP-RIGHT SCAFFOLDS DIV UP-RIGHT INC
 1013 Pardee St Berkeley CA 94710
 415 843-0770

Towers VS

URSA MAJOR INC
 Box 18 Belmont MA 02178
 617 489-0303

Audio delay systems; mechanical reverb units; audio special effects VS

“The Image System can make any 3/4” VTR look like 1”, automatically!”

A strong statement for a strong system. The Image System™ is the most comprehensive system ever invented to correct predictable deficiencies in color under video tape formats and the first to do it automatically.

The Image System — Record 1 and Playback 1 — a bold new idea from Faroudja Laboratories, for ten years the pioneer and leader in processing technology for better television pictures.

Traditionally, image improvement systems have attempted to recover and rebuild information already lost or degraded in production and post-production stages. Further, these attempts have been based upon an operator's subjective judgements about picture quality on a particular, and not necessarily accurate, playback monitor.

The Image System is different. It consists of a pre-processor called Record 1™ and post-processor called Playback 1™.

Record 1 boosts small details which will be predictably degraded or lost in all color under VTR formats. Further, Record 1 encodes the original video signal with a non visible, fully compatible pilot signal which will later control Playback 1 to set detail levels *automatically* without operator error based upon monitor performance.

Portable RECORD 1



Playback 1, the second part of the Image System, is utilized just before time base correction for broadcast. It reduces noise and ringing, eliminates chroma/luminance delay and sharpens details; *automatically*. The resulting picture does not have the cartoon effect or plastic appearance of color under formats — it looks as if it comes from a more expensive VTR.

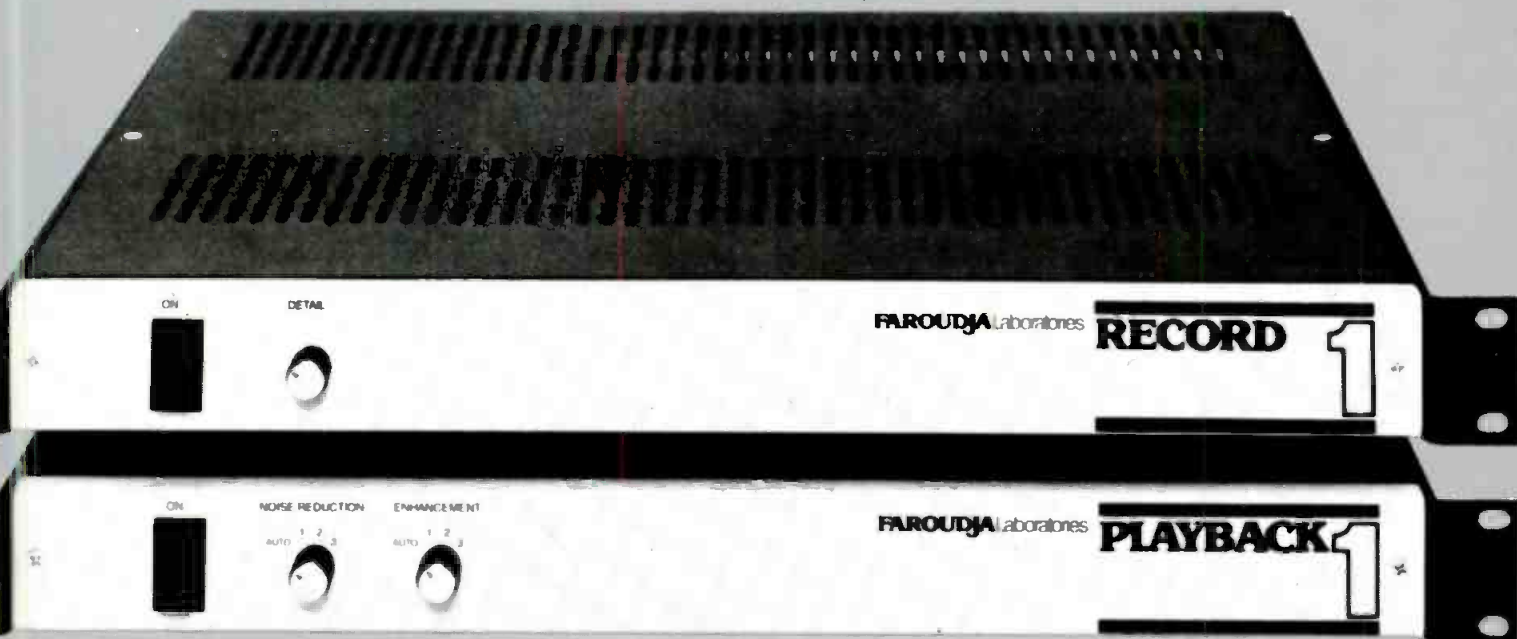

FAROUJJA Laboratories

Faroudja Laboratories Inc.
946 Benicia Avenue
Sunnyvale, California 94086
Telephone 408/245-1492

Circle 209 on Reader Service Card

www.americanradiohistory.com

More Than 360° of Phase >>>> QUICKLY WITH THE **Matthey UN360** VIDEO TIMING TOOL



- Video Performance ●75Ω
- 10-325ns ●Passive
- ±4ns Trim

Television Equipment Associates, Inc.

BILL PEGLER, Director
BOX 260 SOUTH SALEM, N.Y. 10590
914-763-8893



Circle 210 on Reader Service Card

System One



- Reel to Reel
- Sequential Controller
- Random Selector
- Kartel
- Reel to Reel
- 19" Rack

Mini One Bay ...

an economical automation system that provides short walk away time. BC's programmable 1600S Sequential Controller gives access to 16 events — expandable to 32 — from up to 9 repeatable audio sources. Programmable internal clock sounds alarm and monitors upcoming programs. Complete stereo system only \$9225. F.O.B. plant.

BROADCAST CONTROLS

bc 9155 Brookville Road
Silver Spring, Maryland, 20910
(301) 587-3505

Circle 211 on Reader Service Card

The Source '80

US JVC CORP

41 Slater Dr Elmwood Pk NJ 07407
201 794-3900

Audio preamps, monitor & power amps; one-output mic mixers; audio cassettes; TV color studio cameras; ENG EFP cameras; electronic still stores; monochrome, color & dc portable picture monitors; portable production switchers; slow mo & variable speed video action recorders; new videotape; two-VTR editor controllers; multi-source video editors; u-type & half-inch VCRs **VS**

See ad pgs 70-71

CA US JVC Corp 1011 W Artesia Blvd Compton
90220 213 537-6020
IL US JVC Corp 2250 Lively Blvd Elk Grove Village
60007 312 364-9300
TX US JVC Corp 3400 So Loop E Houston
77021 713 741-9470

US PIONEER ELECTRONICS CORP

85 Oxford Dr Moonachie NJ 07074
201 440-8100

Tape recorders; headphones; mics; stereo monitor receivers; speakers **VS**

UTAH SCIENTIFIC INC

2276 So 2700 W Salt Lake City UT 84119
801 973-6840

Video, audio & tally routing switchers & controls **VS**
See ad pg 102—refer to rep/dist section

UTILITY TOWER CO

3200 NW 38 PO Box 12369 Oklahoma City OK
73157

405 946-5551

Automated lighting control systems; FM antennas **VS**

V

VACUUM TUBE INDUSTRIES INC

35 Pequit St Box 358 Canton MA 02021
617 828-1650

Vacuum power tubes, rebuilt

VALAD ELECTRIC HEATING CO

160 Wildey St Tarrytown NY 10591
914 631-4927

Electric heaters for mobile vans & stations

VALLEY PEOPLE INC

PO 40306/2820 Erica Pl Nashville TN 37204
615 383-4739

Audio preamps; AM & FM compressor limiters; complete automation equip systems; facility turnkey installation; recording studio services **VS**

VALTEC CORP COMMUNICATION FIBEROPTICS DIV

99 Hartwell St W Boyleston MA 01583
617 835-6082

Fiberoptic video transmission systems for broadcasting & CAI V **VS**

See ad pgs 123, 125

VAMCO ENGINEERING

11104 E 56 St Tulsa OK 74145
918 252-5448

Digital tape timers; clock systems; A V dist. amps; videotape timer (also for ENG & TVC); A V routing switcher

VAN LADDER INC

PO Box 1557 Spencer IA 51301
800 831-5051

Aerial lifts **VS**

VARIABLE SPEECH CONTROL CO

185 Berry St San Francisco CA 94107
415 495-6100

Speed controlling modules (speech compressors, pitch correctors) for film & tape; audio cassette player/recorders **VS**

VS MEANS IT'S VERIFIED



when you've got it, FLAUNT IT!

And QEI's got it... the line of broadcast equipment that the industry is looking at... and buying.

FM ATS
SCA MONITORS
AM, FM and FM Stereo Modulation
Monitors
Stereo and SCA Generators
AM and FM RF Amplifiers
FM Exciters for both replacement
and OEM

It's all here... competitively priced
with on time delivery and complete
back up by QEI trained technicians.

For additional information contact:

QEI
CORPORATION

Route 73 Kresson, NJ 08053 (609) 767-8052

Quality-Excellence-Integrity

Circle 212 on Reader Service Card

VICTOR DUNCAN VIDEO

For more than 20 years, the Victor Duncan 'check and double check' symbol has assured producers that the equipment they needed was as clean and mechanically perfect as skilled technicians could make it. Every camera package, each light, even the smallest piece of production gear has been carefully *checked*, not once — but twice; before it ever leaves our office.

✓ check and
✓✓ double
check

The Standard for Electronic Production Equipment



This attention to detail begins with a comprehensive physical inspection. Each mechanical function of our video cameras is carefully checked. Housing screws are tightened, lens functions are

verified. The camera is mechanically and electrically registered. The white and black balance is adjusted. Colorimetry is *double checked*. The signal to noise level is carefully monitored.

Each Video recorder is also subjected to the same physical inspections, including the signal to noise levels. The interchange of tapes from deck to deck is carefully checked.

And then a second *check* is made of the complete system as a unit; camera, recorder, switchers and accessories. These same careful steps are used on each piece of equipment ordered. Switchers, monitors, CCU's, all are put through the same detailed electronic tests before they ever leave our department.

These *double check* procedures insure flawless performance in the field, and guard against costly production tie-ups. "Check and double check" at Victor Duncan Video.



VICTOR DUNCAN, INC.

Film and Video Production Equipment

Chicago

200 East Ontario, Chicago, IL 60611 (312) 321-9406

Dallas

2659 Fondren, Dallas, TX 75206 (214) 369-1165

Detroit

32380 Howard, Madison Hgts., MI 48071 (313) 589-1900

Professional Remote
Audio Mixer
\$289. complete



Call or write:

BSM
SYSTEMS

Manufacturers Of Quality
Broadcast Equipment

2646 E 37th Ave.
Spokane, WA 99203
(509) 448/0697

Circle 214 on Reader Service Card

Our Beaucart MONITOR II speaks for itself



\$800

The Beaucart Monitor II has its own built-in amplifier and speaker plus a headphone jack for private listening and a convenient front panel volume control, making it ideal for your NEWS-ROOM, CONTINUITY DESK, SALES OFFICE, PROGRAM DIRECTOR or anywhere you need to play cartridges without the inconvenience of an external amplifier and speaker. Flip a switch and the Monitor II is a conventional reproducer—ready to go on the air or feed a phone line. All these features—plus Beaucart's rugged reliability—at an affordable price.

ORDER TOLL FREE
800 243-6178

UMC

UMC ELECTRONICS CO
460 SACKETT POINT ROAD
NORTH HAVEN, CONN. 06473
(203) 288-7731

Circle 215 on Reader Service Card

The Source '80

VARIAN ASSOC EIMAC DIV
301 Industrial Way San Carlos CA 94070
415 592-1221
RF Tubes: vacuum tubes; remote pickup equip VS

VARIAN ASSOC ELECTRON DEVICES GROUP
611 Hansen Way Palo Alto CA 94303
415 493-4000
See also EIMAC

Intercity & airborne microwave equip: RF amps, attenuators, filters, converters & loads; satellite earth station; receivers, comm & monitor; chart recorders: VHF & UHF TV transmitters; solid state components; vacuum tubes VS

VARIAN/BEVERLY MICRO-LINK PRODUCTS
8 Salem Road Beverly MA 01915
617 922-6000

ITFS & MDS microwave & systems; microwave RF components, assemblies & subsystems; exciters, modulators, TV translators VS

VEGA DIV OF CETEC—See Cetec Vega

VERSA COUNT ENGINEERING
553 Lively Blvd Elk Grove Village IL 60007
312 593-0208

Video processing amps; FM and TV translators; FM transmitters; exciters; RF amps; modulation monitors; audio dist amps; intercity microwave equip; microwave STLs VS

VIDAIRE ELECTRONICS MFG CORP
150 Buffalo Ave Freeport NY 11520
516 623-6696

Audio preamps, power supplies for amps; disc pickup arms; headphones; RF & hardwired intercom systems; dynamic & condenser/electret mics; FM antennas; multimeters; audio connectors; tools; transformers VS

VIDEO AIDS OF COLORADO
1930 Central Ave Boulder CO 80301
303 443-4950

Audio monitor & power amps; hardwired intercoms; video dist amps; sync & black burst generator systems; VTR editor/controller; automatic TV monitors; burst phase meters; video generators, cross pulse; phase meters; vectorscopes; VIRS inserter VS

See ad pg 197—refer to rep/dist section

VIDEO ASSOCIATES LABS
2304 Hancock #1-F Austin TX 78756
512 459-5684
Frame synchronizers VS

VIDEO DATA SYSTEMS
5647 Waterbury Way Plaza Ste D202 Salt Lake City UT 84121
801 272-9296

Character generator systems; production titlers VS

See ad pg 27

CO	Karol Loeffler 316 S Humboldt Denver 80209
GA	Dave Allen 3835 Willow Brook Dr Douglas ville 30135 404 942-8669
NJ	Tony Keator 54 Harvard Rd Fair Haven 07701 201 747-5122
UT	Barry Kenyon 5630 Waterbury Salt Lake City 84121 801 272-9296
WI	Vern Bentrand RR 1 Box 235 Lodi 53555 608 592-3272

VIDEOMAGNETICS
155 San Lázaro Sunnyvale CA 94086
408 737-8300
New VTR heads; head refurbishing VS

VIDEOMAX — See CMC Corp

VIDEOMEDIA INC
250 N Wolfe Rd Sunnyvale CA 94086
408 733-6500
Two-VTR editor/controllers; multi-source video editors; computerized auto assembly editors; rentals of production & post-production equip; facility turnkey installation VS



SPECIFY

SILVERCEL BATTERIES

by **Yardney**

- Ideal For Electronic News Gathering ...Cameras And VTR Equipment
- 3 Times The Power...Much Less Weight

The accepted standard of excellence, Yardney Silvercels are LIGHTER but MORE POWERFUL. Many more running hours are built into Silvercels than any other system of comparable size and weight.

QUICK CHARGE when needed without battery damage. No discharge memory problems. Your camera will never be out-of-service because of charging problems.

Selected by original camera manufacturers and in demand as replacement batteries everywhere. Write for catalog.

Yardney
ELECTRIC CORPORATION

82 Mechanic Street
Pawcatuck, Connecticut 06379
(203) 599-1100

Circle 216 on Reader Service Card

Before you put all your remote control eggs in one basket...



CHECK OUT TFT'S MODULAR AND "INDEPENDENT" REMOTE CONTROL SYSTEM

While you may shell out a few less dollars for so-called "integrated" uP remote control systems, you can really lay an egg when one system component fails and you're OFF-THE-AIR.

Not the case with TFT's 7000 series systems. All major building blocks are designed to work *independently* as well as integrate into a complete uP system.

INDEPENDENT CONTROL FUNCTIONS

Model 7610 and 7830 provide a combined 110 channel UP/DOWN control and direct ON/OFF control. It is a fully digital, pulse code modulated FSK signal using double-store-compare verification techniques, providing interference-free and fully reliable operation.

INDEPENDENT TELEMETRY AND STATUS

The counterpart of the 7610 and 7830 (located at the transmitter) provides up to 110 channels of digitized analog and status data via the phone line, SCA subcarrier and TSL. These functions are redundantly backed up by the uP-computer assisted alarm, logging and CRT display system - Model 7840.

INDEPENDENT uP-COMPUTER ASSISTED ALARM, LOGGING AND CRT

Easy to add to any existing remote control system, this subsystem consists of a Model 7840 CPU, Model 7841

Scanner, Model 43 Printer and Model 400 CRT. Up to 60 data channels can be scanned and compared to limits stored in the operator input values. The system provides alarm, logging and display and will not take you OFF-THE-AIR if it fails.

Special features of the TFT 7000 series system include modular, field-expandable design, one man calibration, selective channel muting, quick-disconnect barrier-strip boards for easy field maintenance and simple front panel operation.

For full facts on the TFT 7000 series dependable and independent system call or write TFT today. We're always hatching new ideas in broadcast engineering.

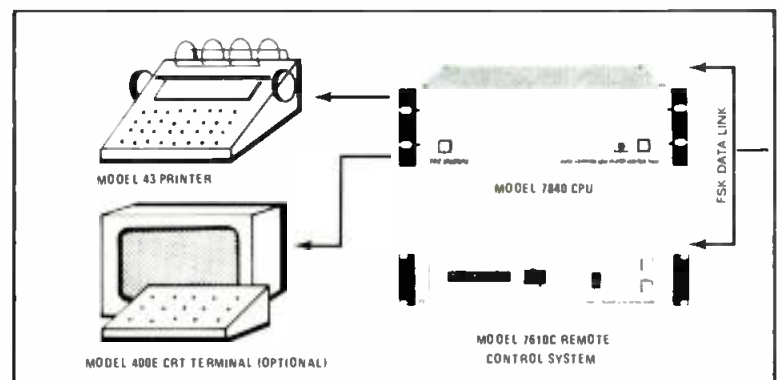

CONTROL SITE BLOCK DIAGRAM

TFT TIME AND FREQUENCY TECHNOLOGY, INC.

3090 OAKMEAD VILLAGE DR., SANTA CLARA, CA 95051 (408) 727-7272 TWX 910-338-0584

Circle 217 on Reader Service Card

BE COMPETITIVE

With the original wide band composite limiter



THE ESP WBL —

- Stops all stereo filter and pre-emphasis wave-form over shoot.
- Increase FM modulation 40% and 15% over other systems.
- Phase coherent wide band for composite stereo.
- Compatible with existing equipment. Will let your present stereo generator do the job it was intended to do.

"We are very pleased with the performance of the Elcom wide band limiter. It is truly a superb unit and it has increased the effectiveness of our Class A signal to very competitive levels in our market"

George M. Arroyo, President
WBRQ-FM
Cidra, Puerto Rico

To increase your FM's effectiveness try a WBL-1 (\$495) or WBL-2 (\$695), rack mount version with remote bypass.



ELCOM
SPECIALTY PRODUCTS, INC.

2810 REDDING AVE., #E
SACRAMENTO, CA 95820
(916) 453-0859
CABLE "ELCOM"

Circle 218 on Reader Service Card

COLOR PRODUCTION SWITCHERS

PRICED
AS LOW AS
\$995

MODEL
1150B

MODEL
1127

MODEL
1107 AC/DC

FOR MORE DETAILS
CALL OR WRITE

140 EAST 10TH STREET
 VANCOUVER, B.C.
 CANADA V6E 2E6
 PHONE (604) 677-7777
 TELEFAX 604-677-7777

Circle 219 on Reader Service Card

The Source '80

VIDEO OPTICS

1916 Old Middlefield Way Mountain View CA 94043

415 965-4298

Low light level camera

VIDEO PRODUCTION SERVICES

1212 10 St Berkeley CA 94710

415 526-6741

Rental of mobile production units; computerized post-production service

VIDEO SPECIALTIES

PO Box 136 Solana Beach CA 92075

714 481-0073

Automation controllers; computer/microprocessor; complete automation systems; custom equip design

THE VIDEO TAPE CO

10545 Burbank Blvd N Hollywood CA 91601

213 985-1666

New & reprocessed videotape; video post-production services; syndicated radio programming services

VS

VIDEOTEK INC

125 N York St Pottstown PA 19464

215 327-2292

Color & dc portable picture monitors; demodulators; waveform monitors & analyzers

VS

See ad pg 146

AZ 9625 N 21st St Dr

Phoenix 85021 602 997-7523

VIDICRAFT INC

4825 SE Hawthorne Blvd Portland OR 97215

233-8295

Image enhancers; video dist amps

VS

VIDTRONICS

855 N Cahuenga Blvd Hollywood CA 90038

213 466-9741

Film to tape transfer; video post-production services

VIF INTERNATIONAL

Box 1555 Mt View CA 94042

408 739-9740

Audio monitor & power amps; ALC & AGC amps; graphic equalizers & filters; relay sequencers; complete automation systems; stereo studio multi-output audio consoles; phono pickup cartridges; headphones; dynamic mics; speakers; open-reel studio tape player/recorders; bulk erasers

VS

VIKRON

520 Blanding Wood Rd S St Croix Falls WI 54024

715 483-3233

Magnetic tape heads

VINTEN—See Listec

VISCOUNT INDUSTRIES LTD

105 E 69 Ave Vancouver BC V5X 2W9

604 327-9446

Video production switchers; distribution amps; routing switchers; sync generator systems; manual master control switchers; small & portable production switchers; special effects generators

VS

See ad pg 152—refer to rep/dist section

VISION-SOUND PROFESSIONAL AUDIO

110 Grand Ave Englewood NJ 07631

201 871-4101

Audio consoles studio; multi-output audio for TV & film (Harrison & NEOTEK); monitor speakers (John Meyer); power amplifiers (Bryston); distr of full audio production & processing equip; recording studio & audio stage design; facility turnkey installations; mobile van installations; financing

VS

See ad pg 144

VISUAL INFORMATION INSTITUTE INC

PO Box 33 Xenia OH 45385

513 376-4361

Sync generator systems; video test materials and generators; monitor calibrators

continued on page 157

The moving coil replacement from Stanton Magnetics... the revolutionary 980LZS!



Now from the company to whom the professionals look for setting standards in audio equipment comes a spectacular new cartridge concept. A low impedance pickup that offers all the advantages of a moving magnet cartridge without the disadvantages of the moving coil pickup. At the same time it offers exceedingly fast rise time—less than 10 micro seconds—resulting in dramatic new crispness in sound reproduction—a new “openness” surpassing that of even the best of moving coil designs. The 980LZS incorporates very low dynamic tip mass (0.2 mg.) with extremely high compliance for superb tracking. It tracks the most demanding of the new so called “test” digitally mastered and direct cut recordings with ease and smoothness at 1 gram.

The 980LZS features the famous Stereohedron™ stylus and a lightweight samarium cobalt super magnet. The output can be connected either into the moving coil input of a modern receiver's preamps or can be used with a preamp, whose output is fed into the conventional phono input.

For “moving coil” audiophiles the 980LZS offers a *new standard* of consistency and reliability while maintaining all the sound characteristics even the most critical moving coil advocates demand. For moving magnet advocates the 980LZS provides one more level of sound experience while maintaining all

the great sound characteristics of cleanliness and frequency response long associated with fine moving magnet assemblies.

From Stanton... The Choice of The Professionals.

For further information write to: Stanton Magnetics, Terminal Drive, Plainview, N.Y. 11803.

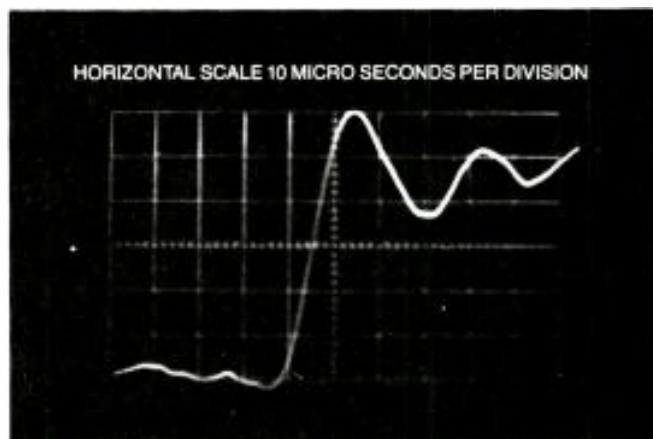

Actual unretouched oscilloscope photograph showing rise time of 980LZS using CBS STR112 record.



STANTON

THE CHOICE OF THE PROFESSIONALS™

Circle 221 on Reader Service Card

Introducing the Ramko a new cart machine, but

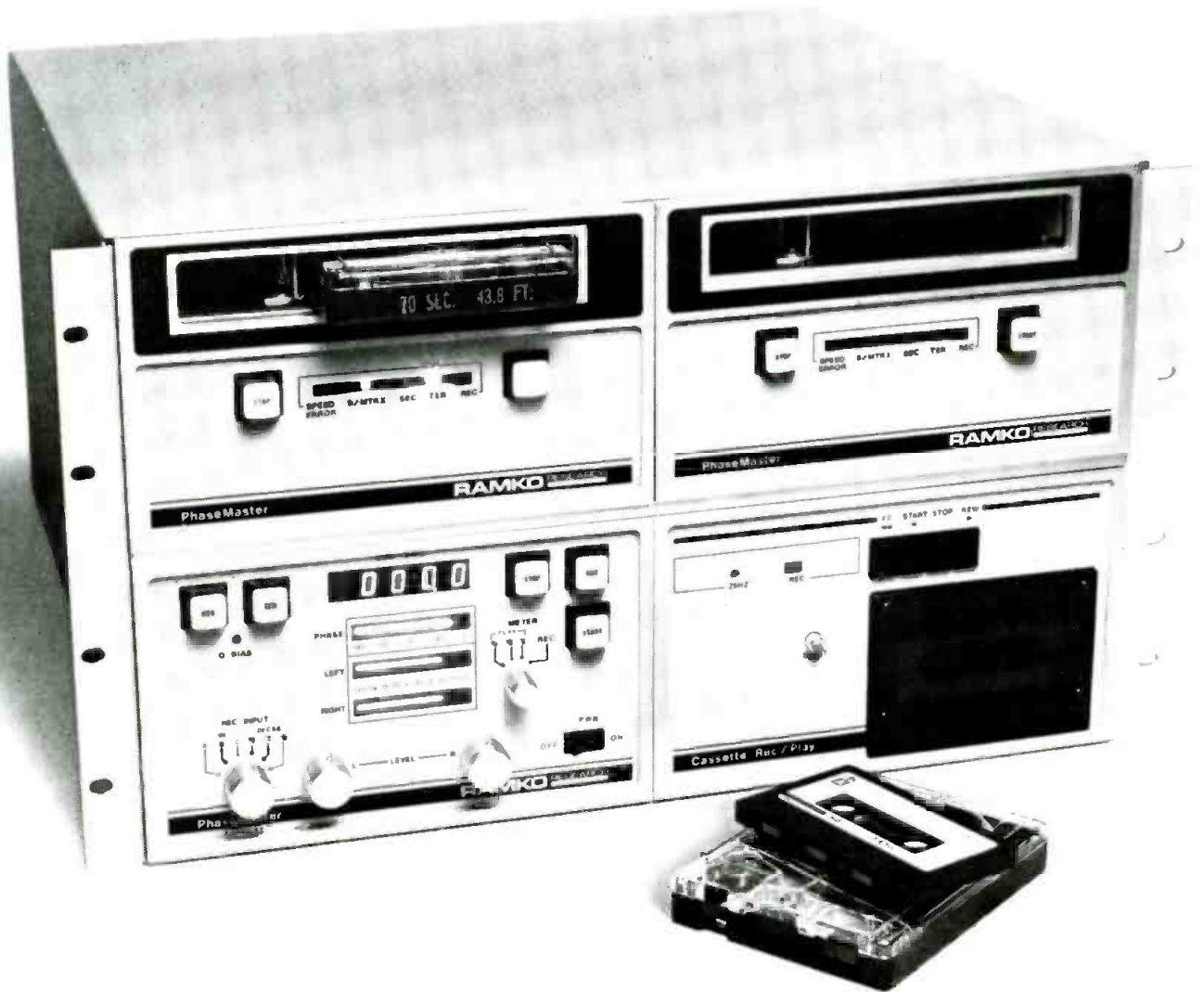

Finally you can get your hands on a cart system with reel-to-reel performance.

A cart system that eliminates phase shift error once and for all. That sets new standards for low wow-and-flutter. That provides signal-to-noise, distortion and frequency response that are better than anything else

in the industry.

Finally, the PhaseMaster.

PhaseMaster: the cart machine, redefined.

The new Ramko PhaseMaster has all the features you want, and some that never existed before.

It's built to take the

pounding you're going to give it, hit after hit, commercial after commercial, day after day.

The deck is a 5/8" casting for stability, with a stainless steel cover plate for wear resistance. The crystal-controlled dc servo motor ensures greater speed accuracy and lower heat

PhaseMaster™ not just a whole new concept.

generation (15 ips, 7½ ips, 3¾ ips motor speeds field-selectable). The machined head stack is rock-stable, and we've included internal illumination for your periodic head inspections and cleaning. There are no micro-switches to break or jam—and never any start-up wow—because the motor is started by an optical sensor as you begin to insert the cart. And the cart hold-down presses on the edges for greater stability and exacting alignment, pressing with roller contact for velvet smooth insertion and withdrawal.

lower track. On playback, the left channel signals from both tracks are compared, and any phase shift difference is corrected automatically by a continuously tracking electronic time delay.

Simple.

And it works—no more holes in your sound, and no more side-to-side spectrum shift.

The ultimate cart system, mono and stereo

The Ramko PhaseMaster System, in mono and stereo, is available as a playback



tronic control center; two A and B cart decks; and a cassette deck.

To record, you switch-select any of three inputs to record on any or all of the decks. When you play back, the control center determines whether your tape is mono or stereo, coded or uncoded, and automatically reproduces the correct outputs.

To dupe, you simply load tape (cart or cassette) and one or two blanks, then hit Record/Play and the control center puts the signal where it's supposed to be.

Call collect for the full-featured brochure

Get the brochure. It covers the PhaseMaster System's convenience and ease of operation; the left, right and phase meters; the 4-digit timer; the three cue tones; the integral testing facilities; and everything that you were hoping would be in it.

Write Ramko Research, 11355 Folsom Blvd., Rancho Cordova, CA 95670. Or if you can't wait for the mail, contact your nearest rep or call (916) 635-3600 collect and arrange for a 2 week free trial.

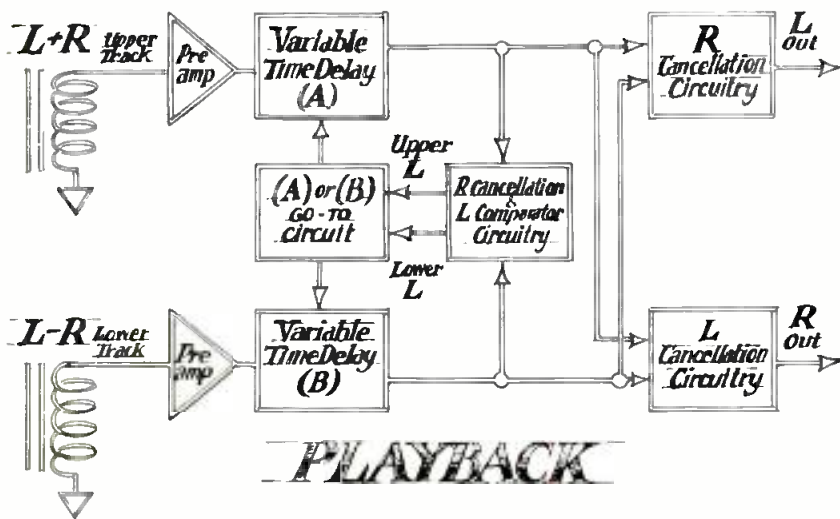

And no more stereo phase shift error

Phase shift doesn't much matter in mono, so when you're recording stereo, the PhaseMaster encodes a mono L + R signal on the upper track, L - R on the

unit or a record/playback deck.

It also comes as a complete reproduction center which duplicates—as well as plays and records—your mono and stereo carts and cassettes. This consists of four modules: an elec-

RAMKO



You wanted precision video level control of multiple, random sources! Now you've got it! The Microtime 2525 SP system.

Only the Microtime 2525 SP insures precision alignment and solid stability of all proc amp controls for up to eight nonsynchronous video sources. When used in conjunction with the popular Microtime 2525 Video Signal Synchronizer, the programmable SP system can guarantee virtually perfect alignment of hue, set up, video and chroma gain for any video source. These sources are fed directly through the Microtime 2525 where they are time based corrected and synchronized.

Programmable features include:

- Complete processing amplifier for 8 independent video signals
- Time base correction or synchronization of any one of 8 signals with automatic optional mode selection
- Full control of image enhancement and noise reduction with the 2121 SP Video Image Processor option.

The 2525 SP also includes operator cues such as video confidence indicators human engineered to minimize inadvertent switching to idle channels. A digital control port is provided to interface the system with existing broadcast computers for station automation application. In

addition the light weight Engineering and Director's Control Panels may be located up to 1000 feet from the equipment area to permit installation in major broadcast system complexes.

The Microtime 2525 SP System and the companion 2121 SP provide significant cost savings over conventional processing equipment and conserve valuable rack space in tight operating conditions.

The 2525 SP—another intelligent application of framestore technology—from Microtime, a world leader in video processing technology.

For more information about the 2525 SP System or Microtime's wide range of broadcast products, contact your Microtime distributor or get in touch with us directly.



MICROTIME

MICROTIME, INC., 1280 Blue Hills Avenue, Bloomfield, CT 06002 • (203) 242-4242 • TWX 710-425-1165

MICROTIME INTERNATIONAL, INC., Rokin 9-15, Amsterdam, Netherlands 1012 KK • 020-23.07.34 • Telex 16354 MI NL

Circle 223 on Reader Service Card

The Source '80

VISUAL METHODS INC

35 Charles St Westwood NJ 07675
201 666-3950

CCTV lenses & accessories, CCTV microwave system VS

VITAL INDUSTRIES INC

3700 NE 53 Ave Gainesville FL 32601
904 378-1581

Audio dist amps; complete automation systems; RGB & encoded chroma keyers; master control switchers (manual, automated, business auto interface); video proc amps; production switchers (large, small, portable, automated); video pulse, dist & subcarrier amps; digital video effects; video source identification systems VS

See ad pg 172

CA 1680 Vine St Suite 1204 Hollywood 90028
1255 Post St Suite 609 San Francisco 94109..... 415 561-9130
IN Morrel Beavers 2644 N 7th St Terre Haute 47804..... 812 466-3212
MN Mike Barsness PO Box 74 Prior Lake 55372..... 612 447-4453
NY Robert McAll PO Box 255 Greenville 12083..... 518 966-5180
Barry Enders 338 E Lake Rd Williamson 14589..... 315 589-9289
TX Gordon Peters PO Box 912 Arlington 76010..... 817 467-0051

W

WALLACH & ASSOCIATES INC

PO Box 18167 Cleveland OH 44118
216 361-7616

Open-reel, cartridge & cassette tape storage; videotape storage; film storage; storage shelves VS

WARD BECK SYSTEMS LTD

841 Progress Ave Scarborough ONT M1H 2X4
416 438-6550

Audio preamps, line, monitor, power & dist amps; amp power supplies; AM compressor/limiters; parametric equalizers & filters; audio consoles (mono & stereo studio multi-output, audio for TV) VS

See ad cover 4

AZ 6900 E Camelback Rd Ste 1010
Phoenix 85251

WATERS MANUFACTURING INC

Longfellow Center Wayland MA 01778
617 358-2777

Audio attenuators & controls, rotary & slide

WAVETEK INDIANA INC

66 N First Ave Beech Grove IN 46107
317 783-3221

Sweep/signal generators, RF detectors; function, signal, sweep generators; oscilloscopes; phase meters; transmission level test set; programmable waveform synthesizers; test accessories VS

WAVETEK ROCKLAND INC

Rockleigh Ind Ct Rockleigh NJ 07647
201 767-7900

Active equalizers & filters, audio & RF; sideband analyzers; spectrum analyzers; frequency synthesizers

WEATHERMATION INC

190 N State St Ste 516 Chicago IL 60601
312 263-6921

Full electronic graphics systems; weather radar systems for TV and radio VS

See ad pg 72

WEATHERSCAN INTL

5100 N Brookline Ste 780 Oklahoma City OK 73112
405 942-1518

Weather information services VS

WEATHER SERVICES INTL CORP

131 The Great Rd Bedford MA 01730
617 275-8860

Weather information services VS

WESTERN BROADCASTING CO ARISTOCART DIV

1960-505 Burrard St Vancouver BC V7X 1M6
604 687-2844

Audio cartridges & test tapes; tape alignment gauges; cart storage VS

WESTERN TELE-COMMUNICATIONS INC

PO Box 22595 Wellshire Station Denver CO 80222

303 771-8200

Satellite communication service; microwave & fiber optic systems VS

WESTERN UNION

1 Lake St Upper Saddle River NJ 07458
201 825-5241

Video & audio transmission via satellite VS

WESTINGHOUSE ELECTRIC CORP/IND & GOVT TUBE DIV

Westinghouse Circle Horseheads NY 14845
607 796-3211

RF & vacuum tubes; rectifiers; low light level surveillance cameras VS

WESTLAKE AUDIO

6311 Wilshire Blvd Los Angeles CA 90048
213 655-0303

Tape splicing blocks & cleaners; speakers; cabinets; furniture; acoustic materials; complete studio construction; facility turnkey installation VS

WESTON INSTRUMENTS DIV OF

SANGAMO-WESTON INC

614 Frelinghuysen Ave Newark NJ 07114
201 242-2600

Analog VU meters, voltmeters, multimeters, dB meters VS

WHIRLWIND MUSIC & AUDIO INC

100 Boxart St Rochester NY 14612
716 663-8820

Cabinets; connectors; wire & cable; mobile van construction; RF cables; complete studio construction

WHITE INSTRUMENTS INC

PO Box 698 Austin TX 78767
512 892-0752

Equalizers & filters (passive & active), real time spectrum analyzers; audio generators

WIDE BAND ENGINEERING CO INC

PO Box 21652 Phoenix AZ 85036
602 254-1570

RF amps; comparator; impedance bridges; directional couplers; power dividers; patch panels; RF filters, detectors, switches; terminations; impedance transformers

WIDE RANGE ELECTRONICS CORP

2119 Schuetz Rd St Louis MO 63141
314 567-5366

Head degaussers; bulk erasers; magnetic recording equip & accessories; optical sound recorders, systems & components

WILCOX-LANGE INC

3924 N Pulsaki Rd Chicago IL 60641
312 588-8380

Free-standing front/rear projection screens VS

WILKINSON ELECTRONICS INC

PO Box 738 Trainer PA 19013
215 497-5100/800 345-8277

AM & FM broadcast transmitters; audio consoles; audio compressor/limiters; distribution amps, equalizers, line amps; demodulators, excitors, RF amps; modulation & frequency monitors; AC line surge protectors; rectifier stacks VS

THE WILL-BURT CO TMD DIV

169 S Main St Orville OH 44667
216 682-7015

Telescoping masts

WINEGARD CO

3000 Kirkwood St Burlington IA 52601
319 753-0121

Over-the-air pay TV equip



WINSTED CORP

8127 Pleasant Ave S Minneapolis MN 55420
612 888-1957

Full line editing, production & VTR consoles; portable production consoles; dubbing consoles for half-inch & 3/4-inch; rack-mount cabinets; tape & film trucks; film & tape storage; cabinets & furniture; equip carrying cases VS

WIREWORKS CORP

380 Hillside Ave Hillside NJ 07205
201 686-7400

Wire & cable; audio interconnect systems; cable components; hardwired multicables; microphone cables; multiboxes; splitters; multitrunks VS

WOLF COACH INC

200 Bartlett St Northboro MA 01532
617 393-2551

Mobile van construction VS

WORLD VIDEO INC

PO Box 117 Boyertown PA 19512
215 367-6055

Color & ac/dc color portable monitors; waveform analyzers; audio monitor amplifiers VS

Y

YAMAHA INTERNAT'L CORP COMBO PRODUCTS DIVISION

6600 Orangethorpe Ave Buena Park CA 90620
714 522-9011

Monitor, power, PA audio amps; active equalizers & filters; special effects; delay lines; integrated mixer/amp; mono, stereo, quad, audio for TV, portable, SR mixing consoles; turntables; headphones; music synthesizers; speakers; tape & cassette player/recorder; cabinets VS

YARDNEY ELECTRIC CORP

82 Mechanic St Pawcatuck CT 02891
203 599-1100

Camera power packs; batteries for production equipment; emergency power; battery chargers VS
See ad pg 150

Z

ZEI-MARK CORP

PO Box 182 Brookfield Center CT 06805
203 355-0008

Optical multiplexer; telecine film chain with preview; film chain adapters for 16 mm & super-8 mm film projectors, lap dissolve slide projector, telecine accessories VS

ZOOMAR INC

55 Sea Cliff Ave Glen Cove NY 11542
516 676-1900

Optics; optical instruments VS

VS MEANS IT'S VERIFIED

EXTEND YOURSELF

If you've ever missed a great shot because of your equipment's limitations, it's time you discovered the incredible, versatile Canon J13X9BIE. A 13X zoom system that will expand your horizons and make you the envy of all your competition.

Here, in a single lens, plus modular accessory package, is the opportunity to realize almost any idea. Any job. Any technique. Any location. Inside or out. Day or night.

Lightweight and rugged and extremely fast at f/1.6, the J13X9BIE has a broad zoom range of 9mm to 118mm. But with our integral 2X range extender, its reach extends all the way to 236mm at a remarkably

sensitive f/3.8. For closeups, it's got a short 0.8M (31.5") M.O.D. plus built-in macro capability. And, of course, it's got adjustable back focus to work with any camera.

But Canon wants you to extend *all* your potential, so it provides the 13X with a complete accessory package. Like our no-light-loss 0.75X wide-angle attachment, giving you a 6.75mm focal length lens with full auto-iris capabilities. A 1.5X teleside converter for even greater focal length extension with no light loss. Remote focusing and zoom—manual or motorized—for tripod

work. And that's still only the beginning. To find out what the best EJ/EFP lens system can do for you, contact us for a demonstration, or specify the Canon J13X9BIE when ordering your new camera.

The next time you tackle an impossible assignment, take along the Canon 13X. If for no other reason than to watch the faces on the competition.



Canon®

Canon U.S.A., Inc. Head Office, 10 Nevada Drive, Lake Success, NY 11040 (516) 488-6700 • 140 Industrial Drive, Elmhurst, IL 60126 (312) 833-3070
123 Paularino Avenue East, Costa Mesa, CA 92626 (714) 979-6000 • Canon Optics & Business Machines, Canada, Ltd., 3245 American Drive, Mississauga, Ontario L4V 1B8, Can
Canon Amsterdam N.V., Industrial Products Division De Boelelaan 8, Amsterdam, Netherlands

Circle 224 on Reader Service Card

INDEPENDENT BROADCAST REPS/DISTRIBUTORS

Including cross reference to companies whose products are advertised

ALABAMA

GEORGE BIRX

Stones mountain GA
404 891-5465

Line: video equip

Anvil Cases see ad pg 84

WILL BONE

Rt 1 Box 27
Pike Radio 36064
205 277-4377

Line: broadcast equip

Harris see ad pgs 12, 32, 127

FM ASSOC LTD

PO Box 1368
Huntsville 35807
96 94 Hwy 20 W
Madison 35758
205 536-9990

Line: broadcast components

Lightning Elimination see ad pg 100

GRAY COMMUNICATIONS

209 Oxmoor Circle Ste 708
Birmingham 35209
205 942-2824
4367 Downtowner Loop N Ste F
Mobile 36609
205 343-0662
5441 Pepsi St.
New Orleans LA
504 733-7265
Line: full line broadcast equip
Anton Bauer see ad pg 93
Arvin/Echo see ad pg 139
ISI see ad pg 83
Ikegami see ad pgs 15, 143

MATEC INC

PO Box 6968
14 Alton Rd
Birmingham 35210
205 956-2200

Line: audio equip

Conrac see ad pg 136

LEE ASSOC MID-SOUTH INC

317 Wheeler Ave
Huntsville 35801
205-533-5896
Line: full line audio & video equip
Marconi see ad pg 120

RADFORD ASSOC

3203 Lanier Dr
Atlanta GA 30319
404 237-6097

Line: video equip

Asaca see ad pg 59

SONICS ASSOC

237 Oxmoor Circle
Birmingham 35209
205 942-9631

Line: audio equip

Inovonics see ad pg 124

Clear/Com see ad pg 146

SPHERE AUDIO SALES

3422 Hurricane Rd
Birmingham 35226
205 979-3561

Line: full line audio equip

BTX see ad pg 176

SIGNAL ENGINEERING & SALES

720 S. 23rd St
Birmingham 35202
205-328-6431

Line: video equip

NEC see ad pg 81

ALASKA

NORTHSHORE MARKETING

15084 NW 65 St
Redmond WA 98052

Line: audio equip

Otari see ad pg 63

UNIVERSAL DATA SYSTEMS

PO Box 10-1888

Anchorage 99511

Line: broadcast components

Lightning Elimination see ad pg 100

ARIZONA

DYMA ENGINEERING

PO Box 1697 213 Pueblo Del Sur
Taos NM 87571

505 758-2686

Line: audio, RF & test equip

Elcom see ad pg 152

INDUSTRIAL VIDEO

11805 N 29 Place
Phoenix 85028

602 971-6626

Line: video equip

ISI see ad pg 83

RA MAYES CO

1445 E Thomas Rd #218
Phoenix 85014

602 279-5243

Line: broadcast components

Lightning Elimination see ad pg 100

MEASUREMENT CONSULTANTS

PO Box 966

Scottsdale 85252

602-994-9519

Line: test instruments

Marconi see ad pg 120

DAVE MENAGAY ASSOCIATES

PO Box 966

Scottsdale 85252

602 994-9519

Line: test & measuring equip

Marconi see ad pg 120

ROH'S INC

4553 E Broadway
Tucson 85711

602 795-8573

Line: full line video equip, CCTV systems

Conrac see ad pg 136

ARKANSAS

HILL RADIO EQUIP CO

Rt 6 Box 622
Claremore OK 74017

918 341-5240

Line: audio, RF & test equip

Elcom see ad pg 152

RALPH HUCABY

1331 Otter Creek Rd
Nashville TN 37215

615 373-0231

Line: video equip

Asaca see ad pg 59

STANLEY COMMUNICATIONS

3600 W 69 St

Little Rock 72209

501 562-9200

Line: full lines broadcast equip

ISI see ad pg 83

Clear/Com see ad pg 146

TENICKI

6432 Wastchester
Houston TX 77005

713 663-6432

Line: audio equip

Otari see ad pg 63

CALIFORNIA

ACCURATE SOUND CO

114 Fifth Ave
Redwood City 94063

415 365-2843

Line: audio equip

Inovonics see ad pg 124

ADTEK ASSOCIATES

201 Town & Country Village
Palo Alto 94301

415 323-5414

Line: video equip

Allen Avionics see ad pg 145

AMERICAN VIDEO PRODUCTS INC

1875 S Santa Cruz St
Anaheim 92804

714 978-9002

Line: video equip

ISI see ad pg 83

AUDIO CONCEPTS

7138 Santa Monica Blvd
Hollywood 90046

213-851-7172

Line: audio equip

ADR see ad pg 130

Clear/Com see ad pg 146

AUDIO INDUSTRIES CORP

1419 N LaBrea Ave
Hollywood 90028

213 851-4111

Line: audio components equip

Inovonics see ad pg 124

AUDIO VIDEO CRAFT

7710 Melrose Ave
Los Angeles 90046

213 655-3511

Line: video equip

Viscount see ad pg 152

TOM AYE ASSOC

1508 Albatross Dr
Sunnyvale 94087

408 738-1406

Line: full line broadcast equip

Sintronic see ad pg 192

BANANAS AT LARGE

802 4 St
San Rafael 94901

415 457-7600

Line: audio equip

Inovonics see ad pg 124

BEDOKA SOUND EQUIP CO

12148 Downey Ave
Downey 90242

213 923-6126

Line: audio equip

Inovonics see ad pg 124

BCD INC

5526 E LaPalma
Anaheim 92807

714 528-9595

1400 Coleman Ave Ste H14

408 984-6614

Santa Clara 95050

3350 Scott Blvd Bldg 48

Santa Clara 95051

408 496-6525

Line: full line broadcast equip

TFT see ad pg 151

BROADCAST CART SERVICE

15131 Triton Ln Unit 108
Huntington Bch 92649

714 898-7224

Line: audio tape & accessories

Aristocart see ad pg 168

BROADCAST COMMUNICATIONS DEVICES INC

2990 E LaJolla St
Anaheim 92806

714 630-8150

1400 Coleman Ave Ste H14

Santa Clara 95050

408 984-6614

Line: full line audio & video equip, lighting equip

Clear/Com see ad pg 146

Conrac see ad pg 136

Datatek see ad pg 179

BROADCAST ENGINEERING

4973 Via Cinta

San Diego 92122

Baja CA

714 275-1028

Line: audio, RF test equip

Elcom see ad pg 152

BROADCAST MKTG ASSOC

155 San Lazaro
Sunnyvale 94086

408 736-3600

Line: full line bdcst equip

ADDA see ad pg 3

Clear/Com see ad pg 146

GERRY BURKHARDT

26311 Marina Rd
San Juan Capistrano 92675

714 495-4047

Line: video equip

UMC see ad pg 150

JERRY CLEMENTS

1110 Mar Ave
Carpinteria 93013

805 684-7686

Line: broadcast equip

Cetec see ad pg 76

COAST RECORDING EQUIP SUPPLY

6114 Santa Monica
Hollywood 90038

213 462-6058

Line: full line audio equip

Inovonics see ad pg 124

DICK ELLIOT

Ross Northern Calif
600 16th St Suite 55 F

Reps/ Dists

California continued

Oakland 94612
415 832-0938
Line: broadcasting equip
Alexander see ad pg 112

EVERYTHING AUDIO
16055 Ventura Blvd Ste 1001
Encino 91436
213 995-4175
Line: full line audio equip
Inovonics see ad pg 124

EXPRESS SOUND CO
1833 Newport Blvd
Costa Mesa 92627
714 645-8501
Line: audio equip
ADR see ad pg 130
Clear/Com see ad pg 146

F&B CECO of CALIF, INC
7051 Santa Monica Blvd
Hollywood 90038
213 466-9361
Line: full line film & video equip
Frezzolini see ad pg 132

WILLIAM HAHN
San Francisco
415 791-8344
Line: video equip
3M Video see ad pgs 56, 117

FUJI OPTICAL SYSTEMS
118 Savarona Way
Carson 90746
213 532-2861
4855 Atherton Ave
San Jose 95013
408 866-5466
Line: video equip
Fujinon Optical see ad pg 181

GENERAL ELECTRONICS SYSTEMS INC
PO Box 11085
1440 San Pablo Ave
Berkeley 94702
415 527-7700
Line: audio & video equip
Conrac see ad pg 136
Clear/Com see ad pg 146

DAVID A HILL
PO Box 1589
Burlingame 94010
415 574-4414
Line: broadcast equip
Harris see ad pgs 12, 32, 127

HOFFMAN VIDEO SYSTEMS
800 W Pico
LA 90015
213 749-3311
Line: full line video equip
ISI see ad pg 83
Clear/Com see ad pg 146

IER
1205 Prospect St Ste 510
LaJolla 92037
714 459-3691
Line: video equip
UMC see ad pg 150

JOHN KIRKEBY
Los Angeles
805 484-8143
Line: video equip
3M Video see pgs 56, 117

LP MARKETING
2036 Livingston St Ste 5
Oakland 94606
415 532-5600
Line: audio equip
Otari see ad pg 63

MARCOM
PO Box 66507
Scotts Valley 95066
408 438-4273
3590 Central Ave Ste 208
Riverside 92506
714 684-7502

Line: full line audio & video equip
Datatek see ad pg 179
Arvin/Echo see ad pg 139
Inovonics see ad pg 124
Knox see ad pg 98
NEC see ad pg 81
TFT see ad pg 151
UMC see ad pg 150

MARSHANK SALES CO
3940 Higuera St
Culver City 90230
213 559-2591
Line: full line A V equip
dbx see ad pg 99

CHARLES MARTIN
PO Box 612
Reseda 91335
213 999-5947
Line: video equip
MCI/Quantel see ad pg 101

MEL AUDIO/VIDEO
1122 East Chevy Chase Dr
Glendale 91205
213 245-7708
Line: full audio & video equip
Inovonics see ad pg 124

CHARLES MICHAEL
13400 Mulholland Dr
Beverly Hills 90210
213 274-4903
Line: full line A V equip
TEA see ad pgs 148, 186, 199

MICRO CONSULTANTS INC
PO Box 612
Reseda 91335
213 999-5947
Line: video equip
MCI/Quantel see ad pg 101

MOULTHROP SALES INC
7080 Commerce Dr
Pleasanton 94566
415 846-0550
Line: audio components, equip
Shure see ad pg 189

MOXON ELECTRONICS
17801 B Sky Pk Circle Dr
Irvine 92707
714 556-6500
2376 Walsh Rd
Santa Clara 95050
408 727-6491
7969 Engineer Rd
San Diego 92111
714 292-4800
1440 S State College Blvd
Bldg 6E
Anaheim 92806
714 635-7600
1970 S Santa Cruz
Anaheim 92806
714 635-7600
9580 Black Mountain Rd
San Diego 92126
714 578-5760
312 W Walnut St
Lodi 95240
209 369-1883
Line: test instruments
Marconi see ad pg 120

NEW WEST
3770 Highland Ave Ste 101
Manhattan Beach 90266
213 545-6668
Line: audio equip
Otari see ad pg 63

OAC INDUSTRIES INC
3423 Investment Blvd Ste 203
Hayward 94545
415 783-6200
Line: audio equip
Eumig see ad pg 185

TOM O'HARA
2836 E Panamint Ct
Westlake Village 91360
213 642-0052

Line: broadcast equip
Harris see ad pgs 12, 32, 127

OMEGA ASSOC
14326 Isis Ave
Lawndale 90260
213 679-9021
Line: full line video equip,
lighting equip
Conrac see ad pg 136

PACIFIC COAST MARKETING
20 S Santa Cruz Ste 309
Los Gatos CA 95030
408 395-7021
Line: audio equip
Ramko Research see ad pgs 28-29,
154-155

PACIFIC RECORDERS & ENG CORP
11100 Roselle St
San Diego 92121
714 453-3255
Line: full line audio equip accessories
ADR see ad pg 130

PACIFIC VIDEO PRODUCTS
2600 E Katella
Anaheim 92806
714 634-8585
ISI see ad pg 83

DON PRATHER
2483 E Bayshore Rd
Palo Alto 94303
415 846-6226
Line: video equip
MCI/Quantel see ad pg 101

PROGRESSIVE MARKETING INC
215 Verbeana Ln
Brea 92621
714 996-8660
75 Mt Hermon Rd
Scotts Valley 95060
408 438-1097
Line: video, transmitting &
measuring equip
Rohde & Schwarz see ad pgs 13, 184

RIGGINS ELECTRONIC SALES
3272 E Willow St
Long Beach 90806
213 598-7007
Line: video equip
Elcom see ad pg 152
UMC see ad pg 150

RINEK CO
PO Box 91251
Los Angeles 90009
213 839-3758
Line: RF equip
Electro Impulse see ad pg 177

EV ROBERTS & ASSOC INC
PO Box 868 8500 Steller Dr
Culver City 80230
213 870-9561 or 800 421-0824
Line: video equip
Allen Avionics see ad pg 145

ROSS COMM
PO Box 5003
Covian 91723
213 919-3446
Line: broadcast equip
Alexander see ad pg 112

PAUL SEAMANCO
14234 Catalina St
San Leandro 94557
415 352-7860
Line: audio equip
dbx see ad pg 99

DON SIMON
Ross 336 Hillcrest
El Segundo 90245
213 322-7114
Line: broadcasting equip
Alexander see ad pg 112

R E SNADER & ASSOC
Scott Hall
111 Seminary Hall
San Anselmo 94960
415 454-7090

Line: video & lighting equip
ISI see ad pg 83
Clear/Com see ad pg 146

THE SOLOMON CO
18740 Oxnard St #304
Tarzana 91356
213 705-3458
Line: audio equip
Eumig see ad pg 185

SOUND DYNAMICS, INC
PO Box 32056
San Jose 95152
408 926-3588
Line: audio components
ESE see ad pg 183

SOUND GENESIS INC
2001 Bryant St
San Francisco 94110
415 285-8900
Line: audio equip
Clear/Com see ad pg 146
Inovonics see ad pg 124
UMC see ad pg 150

SYSTEM ASSOC
5801 Uplander Way
Culver City 90230
213 641-2042
Line: full line audio & video equip
Utah Scientific see ad pg 102

TABER MFG & ENGINEERING
2081 Edison Ave
San Leandro 94577
415 635-3831
Line: audio equip
Inovonics see ad pg 124

TRI TRONICS INC
2921 W Alameda Ave
Burbank 91505
213 843-2170
Line: full line video equip
Conrac see ad pg 136
Ikegami see ad pgs 15, 143
ISI see ad pg 83

VIDEO EQUIPMENT CORP OF AMERICA
7377 Convoy Ct
San Diego 92111
714 278-4400
Line: audio & video equip,
lighting equip
Asaca see ad pg 59
Arvin/Echo see ad pg 139
ISI see ad pg 83
UMC see ad pg 150
Skotel see ad pg 108

VIDEO SYSTEMS NETWORK
12530 Beatrice St
Los Angeles 90066
213 390-7575
Line: full line video equip,
lighting equip
Asaca see ad pg 59
Arvin/Echo see ad pg 139

VIF INTL
1151 Viscaino Ave
Sunnyvale 94086
408 739-9740
PO Box 1555
Mountain View 94042
408 739-9740
Line: full line audio & video equip
Inovonics see ad pg 124
Hallikainen see ad pg 140

WESTLAKE AUDIO
6311 Wilshire Blvd
Los Angeles 90048
213 655-0303
Line: full line audio equip
ADR see ad pg 130
Inovonics see ad pg 124
UMC see ad pg 150

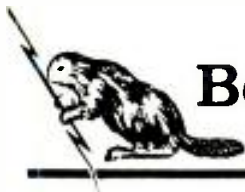

Beaveronics, Inc.

STUDIO PRODUCTION VIDEO SWITCHING SYSTEMS

8 Haven Avenue
Port Washington, New York 11050
Tel: (516) 883-4414

(Also available in PAL and PAL-M versions)

FOR REMOTE & SMALL PRODUCTION FACILITIES

MODEL J & D 712

\$7,400.00

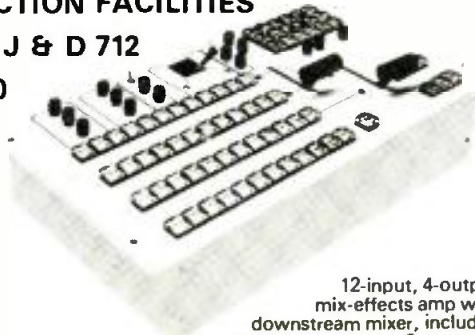

12-input, 4-output mix-effects amp with downstream mixer, includes downstream preset & program busses with cut bar, RGB chroma key

Standard Features

- 12 inputs including Black-burst and Color Background
- Built-in Black Burst Generator
- Built-in Colorizer
- Built-in RGB Chroma keyer
- Four Switching busses
- Downstream Preset and Program Busses with cut bar
- Rack-mounted electronics
- Adjustable Soft Wipe
- Adjustable Border edges
- Color Matte
- Vertical Interval switching thru-out
- Illuminated Momentary Contact push buttons
- Internal, external, Chroma-key, and matte inputs to keyer

- Built-in pattern modulator with frequency and amplitude controls
- Full Tally
- Pattern symmetry control
- Illuminated Momentary contact push buttons for effects selection
- Normal/Reverse/Normal-reverse wipe transitions
- Pattern limit controls for presetting size of patterns or varying vertical and horizontal aspect ratio
- Loop-through inputs
- Input amplifiers with clamping
- Synchronous/Non-synchronous inhibit
- Modular construction with front access plug-in modules

Options:

Downstream Keyer

FOR MODERATE SIZE FACILITIES

MODEL B1-154

\$12,990.00



15-input, 4-bus mix/eff/key amp with downstream mix/key amp. Many optional features including DSK & quad-split, etc.

FOR SOPHISTICATED FACILITIES

MODEL B1-156

\$21,795.00



15-input, 6-bus with two full mix/eff/key systems and dir, pgm and pre busses: many options available, DSK, quad, etc.

MODELS 154 & 156

STANDARD FEATURES

- Switcher Models 154 and 156** are of the same basic design and utilize the same electronic sub assemblies. These switchers have the same standard basic features, differing only in the number of busses and in the number of mix/effects units. The basic standard features include 32-pattern mix/effects, color black and color matte background generator, and a mix/key unit in the case of the Model 154.
- Input Amplifiers**
 - loop through high impedance input
 - gain equalization for 1000' cable
 - 22° sub carrier phase control
 - clamped inputs (10% to 90% APL)
 - sync addition on non composite signals if desired.
- Tallies**
 - isolated dry contact relay closure on all inputs (2 amps at 50 v.)
- Mix-Effects Units (Includes Keying Function)**
 - One (1) used in Model B1-154
 - Two (2) used in Model B1-156.

Fades (or Supers), Wipes, Keys may be produced.

Positioner Joystick for each M/E positions patterns.

 - **Pattern Modulation** may be accomplished by an internal waveform generator. Modulating sources may be either (1) sine wave, (2) square wave, (3) saw tooth, or (4) an external customer generated source.
 - **Mix Key and Wipe Key** available.
 - **Soft Wipe and Soft Key** available with adjustable variations.
 - **Push to Preview** obtained by depressing knob on clip potentiometers (provides for M/E monitor output).
 - **Wipe Mode**—3 interlocked buttons select "NOR", "REV" or "N/R".
 - **Hard Wipe, Soft Wipe or Border** can be selected with degree of softness made by "Edge" control adjustment.
 - **Border may be Colored by adjustment of "Hue" and "Luminance" control.**
 - **Symmetry of Pattern** may be adjusted by "SYM" knob.
 - **Preset Wipe Limits** are set by potentiometers. "H" and "V" vertical preset limits activated by Pattern Limit button.
 - **Spotlight alternate action** push button produces a 6 db. level difference between "A" and "B" input channels in the "Wipe" mode. (Operates on all patterns.)
 - **Pattern Assignment** is made by depressing "ASSIGN" button. Pattern select

- feature may be "locked" to pattern matrix by depressing the "ASSIGN" button a second time on the same pattern. Patterns assigned appear on LED display on M/E control panel.
- **Non-Synchronous Inputs.** An "NS" indicator is provided. Tearing is prevented by not allowing a non-synchronous signal to be switched except at extreme position of fader handle where a "cut" transition occurs.
 - **Key Input Sources** may be either (1) "A" bus video for self keying, (2) preview Key bus, (3) chroma key, or (4) an external key source.
 - **Key Invert** selector provided to accommodate either positive or negative video as a keying source.
 - **Key Fill** may be either "A" video for self keying or a colorized matte.
 - **Mix/Key** provided a lieu of second Mix/Effects system for Model B1-154 switching system. Provides for all mix and keying functions of mix/effects system (as previously described) except for the pattern effects.

OPTIONAL FEATURES

May be added at any time (required control panel wiring already installed)

- Chroma Keyer (C.K.)** \$950.00
 - Hue—selects hue of keying color
 - Gain—adjusts the amplitude
 - Clip—adjusts the Clip level for keying
 - Camera (4 x 1) input switcher—selects RGB output of any one of 4 cameras to feed C.K.
 - Down Stream Keyer (DSK)** \$1,975.00
 - Keys in titles, inserts, or fades to black with or without insert
 - Color matte background
 - Key sources: (1) Mix/Effect, (2) Chroma Key, (3) External
 - Push to Preview (Monitor)
 - OSK Border** \$1,950.00
 - Border—black edge around insert
 - Shadow—black edge on right side and bottom of insert
 - Quad Split** \$1,900.00
 - Provides four (4) variable size quadrants from eight possible sources with variable width border.
 - Aux Busses—(Model 156 only)** \$2,100.00
 - Two remote outputs are available—remote control panel and amps required.
 - 2nd Mix/Effects Unit in lieu of Mix/Key amp in 154** \$2,650.00*
 - Mix/Key amp fed by preview and program busses in 156** \$3,500.00*
- *Except those indicated with an asterisk.

All Beaveronics Switching Equipment Carries a Two Year Warranty

OTHER ITEMS AVAILABLE FROM BEAVERONICS

FAVAG MASTER CLOCK SYSTEMS

Available with accuracy better than 1 second/yr.

- Master control switchers AFV with audio breakaway
 - Routing switchers with AFV
- CHECK BEAVERONICS FOR:
- Specialized custom switchers
 - Selected terminal equipment



Write or phone for details.

Table Top

Surface Mtg.

Semi-flush

Beaveronics, Inc. 8 Haven Avenue • Port Washington, New York, 11050 • Tel: (516) 883-4414

Prices and Specifications Subject to Change Without Notice.

Circle 225 on Reader Service Card

Now that we're selling.

Look who's buying.

Compact Video has pioneered video communications for almost a decade. Our user-oriented experience has earned us recognition as the experts in design, consultation and installation of broadcast and satellite transmission centers. We're also known as the foremost builders of mobile location vehicles.

For the broadcaster and cablecaster, Compact Video offers a choice of six standard mobile location systems to meet every production demand. Or we will custom design a mobile system to your exact specifications. From our two rugged ENG's to our one-of-a-kind transportable uplink Earth station, our mobile systems are engineered to deliver maximum efficiency, optimum performance and increased profitability.

Whether you're considering a broadcast or satellite transmission center, a television complex, editing or audio facilities, or just a simple screening room, *Call on Compact Video today.* We make state-of-the-art technology practical.

ESPN
TRINITY
TELEVISA
PLAYBOY PROD.
KOLO-TV
KWTV
NET
OMNICOM

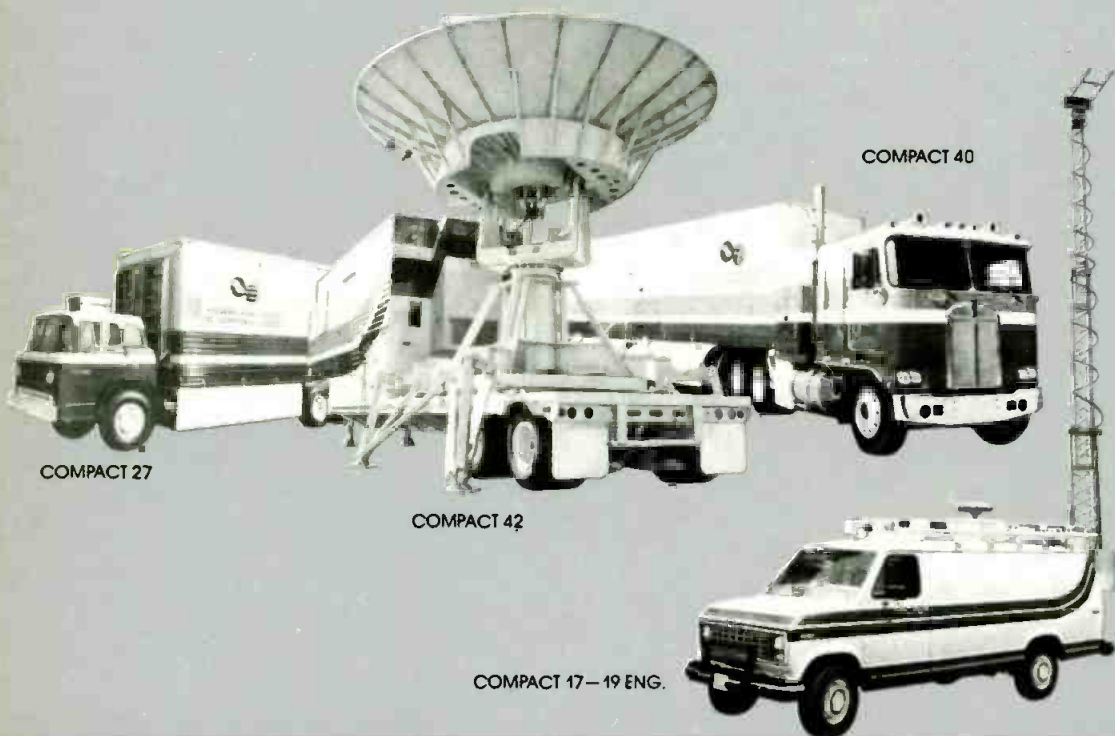

COMPACT VIDEO

Sales, Inc.

MAIN OFFICE: 2813 WEST ALAMEDA AVENUE, BURBANK, CALIFORNIA 91505 (213) 843-3232
REGIONAL OFFICES: Eastern (212) 732-9150 / Midwest (312) 337-5333 / S. Eastern (404) 355-5255 / S. Western (214) 783-0044

TELEX: 494855 TWX: 910-498-4987
CMPVIDEO

Circle 226 on Reader Service Card

Reps/Dists

COLORADO

AUDIO-VIDEO SYSTEMS INC
3390 Peoria Ste 306
Aurora 80010
303 341-9994
Line: audio & video equip
ISI see ad pg 83

AUDITIES — 2001 ENTERPRISES
2377 E Mississippi Ave
Denver 80209
303 777-4595
Line: audio equip
Otari see ad pg 63

AURORA MARKETING
6 Prker Pl Suite 265
Aurora 80014
303 751-2027
Line: Broadcast equip
Alexander see ad pg 112

B&B ELECTRONIC PRODUCTS INC
500 Quebec S
Denver 80237
303 773-6700
Line: audio equip
Otari see ad pg 63

BROADCAST COMMUNICATION PRODUCTS
PO Box 204
Golden 80401
303 424-3231
Line: audio equip
Inovonics see ad pg 124

CEC
1602 S Parker Rd Ste 102
Denver 80231
202 751-3252
Line: full line audio & video equip
Marconi see ad pg 120

COLORADO MILE HIGH MARKETING
9191 D N Washington St
Thornton 80229
303 457-2058
Line: video equip
Knox see ad pg 98

DAVIS AUDIO-VISUAL INC
1801 Federal Blvd
Denver 80204
303 455-1122
Line: video & lighting equip
Conrac see ad pg 136

DIDIER/DENVER INC
PO Box 2537
Grand Junction 81501
303 243-5373
11465 W 48 Ave
Wheat Ridge 80033
4665 Kipling
Wheat Ridge 80033
303 422-6666
Line: full line broadcast equip
ADDA Corp see ad pg 3
Asaca see ad pg 59
Datatek see ad pg 179
Lightning Elimination see ad pg 100
TEA see ad pgs 148, 186, 199

DYMA ENGINEERING
PO Box 1697 213 Pueblo Del Sur
Taos NM 87571
505 758-2686
Line: audio, RF test equip
Elcom see ad pg 152

GENERAL SOUND & ELECTRONICS
1369A W Byers Pl
Denver 80223
303 722-1861
Line: audio & video equip
Clear/Com see ad pg 146

MAGNETIC MEDIA
8745 Orchard Rd Ste #518
Englewood 80111
303 770-6340
Line: video equip
ISI see ad pg 83

HP MARKETING
2530 W Church Ave
Littleton 80120
303 794-8367
Line: audio & test equip
dbx see ad pg 99
Eumig see ad pg 185

RA MAYES CO
1050 Yuma St Rm 301A
Denver 80204
303 893-2264
Line: broadcast components
Lightning Elimination see ad pg 100

JF HURLBUT CO
622 Gardenia Ct
Golden 80401
303 279-7796
Line: video equip
Allen Avionics see ad pg 145

MILE HIGH MARKETING
1813 E 98th Pl
Thornton 80229
303 457-2058
Line: video equip
Knox see ad pg 98

PAR ASSOC
7305 Spring Ct
Boulder 80303
303 499-4736
Line: test instruments
Marconi see ad pg 120

MIKE SHAFER
PO Box 2537
Grand Junction 81501
303 243-5373
Line: broadcast equip
Cetec see ad pg 76

UNITED TAPES OF AMERICA
PO Box 1193
Grand Junction 81501
303 242-0405
Line: audio equip
Inovonics see ad pg 124

CONNECTICUT

JOHN B ANTHONY
992 High Ridge Rd
Stamford 06905
203 322-9202
Line: full line audio equipment
Otari see ad pg 63
dbx see ad pg 99
Eumig see ad pg 185

APPLIED MEASUREMENTS INC
PO Box 5181
2349 Whitney Ave
Hamden 06518
203 288-5288
Line: broadcast components
Lightning Elimination see ad pg 100

AUDIO/TECHNIQUES INC
652 Glenbrook
Stamford 06906
203 359-2313
Line: full line audio equip, recording accessories imported and domestic
ADR see ad pg 130

CAMERA MART
456 W 56 St
New York NY 10019
212 757-6977
Line: video & film equip
Camera Mart see ad pg 129
Arvin/Echo see ad pg 139

CHAMBERLIN & MURRAY INC
2001 Whitney Ave
Hamden 06518
203 288-4026

Line: audio equip
Ramko Research see ad pgs 28-29, 154-155

DAVID DEVER
300 Broad St Ste 511
Stamford 06901
203 348-4104
Line: video equip
MCI/Quantel see ad pg 101

GMI
181 Worchester Rd Rt 9
Natick MA 01760
617 237-6544
Line: audio equip
Otari see ad pg 63

HAL KNELLER
47 Wood Pond Rd
W Hartford 06107
203 521-7050
Line: broadcast equip
Harris see ad pg 12, 32, 127

MICRO CONSULTANTS INC
300 Broad St
Stamford 06901
203 348-4104
Line: video equip
MCI/Quantel see ad pg 101

NESA CORP
12 Silvermine Road
Brookfield Center 06805
203 775-0578
Line: broadcast equip
Alexander see ad pg 112

DELAWARE

RON PHENICIE
Danville PA
717 275-7900
Line: video equip
Anvil Cases see ad pg 84

DISTRICT OF COLUMBIA

ASSOCIATED SALES REPS
403 Fieldstone Ct
Fallstone MD 21047
Line: audio equip
Otari see ad pg 63

COMREX CORP
PO Box 17011
Dulles Intl Airport
Washington 20041
703 471-4215
Line: full line video equip
Ramko see ad pgs 28-29, 154-155

INSTRUCOM INC
1629 K St NW Ste 500
Washington DC 20006
202 223-1759
Line: broadcast components
Lightning Elimination see ad pg 100

PROFESSIONAL PRODUCTS INC
4964 Fairmont Ave
Bethesda 20014
301 933-3451
Line: full line video equip

VARK AUDIO
1028 3rd St NW
Washington DC 20007
202 333-4361
Line: audio equip
Inovonics see ad pg 124

DWIGHT WILCOX
Washington DC
301 258-7676
Line: video components
TEA see ad pgs 148, 186, 199

FLORIDA

ALEXANDER BATTERY
Box 1053
Pompano 33062
305 781-1181
Line: broadcast equip
Alexander see ad pg 112

BCA
PO Box 2606
312 Hwy 74 S
Peachtree GA 30269
404 487-9559
Line: audio, RF & test equip
Elcom see ad pg 152

BENCNIK ASSOC
1311 NE 13th Ave
Ocala 39670
Line: audio equip
Modular Audio see ad pg 90

GEORGE BIRX
Stonesmountain GA
404 891-5465
Line: video equip
Anvil Cases see ad pg 84

BROADCAST AUTOMATION ASSOC INTL
PO Box 5882
Ft Lauderdale 33310
305 522-1000
Line: broadcast equip
UMC see ad pg 150

CONTINENTAL ELECTRONICS WHOLESALE CORP
1620 W 32 St
Hialeah 33012
305 822-1421
Line: audio & RF equip
Inovonics see ad pg 124

CONTROLLED TECHNOLOGY INC
991 SW 27 Ave
Ft Lauderdale 33312
305 587-2716
Line: full line audio & video equip
UMC see ad pg 150
Hallikainen see ad pg 140

CRESCENDO ASSOC
3597 SW 69 Terrace
Miramar 33023
305 961-0886
Line: audio equip
Otari see ad pg 63

CRESCENDO NORTH
6510 Lakeshore Dr
Gainesville 32601
904 372-0881
Line: audio equip
Otari see ad pg 63

ELECTREX CO
18680 NE 2nd Ave
Miami 33179
305 945-6483
Line: audio & video equip
Ramko see ad pgs 28-29, 154-155

FIRESTONE & ASSOC
531 Sun Up Trail
Boynton Bch 33436
Line: audio equip
Eumig see ad pg 185

FLORIDA'S EVERGREEN
5209 NW 74 Ave
Miami 33166
305 592-6051
Line: audio equip
Inovonics see ad pg 124

FM ASSOC LTD
5018 Mortier Ave
Orlando 32812
305 851-5710 or 851-5716
PO Box 996 110 Yacht Club Pl
Jupiter 33458
305 746-2996
Line: broadcast components
Lightning Elimination see ad pg 100

Reps/Dists

Florida continued

SUMINISTROS GONZALEZ

940 Lincoln Rd
Miami Bch 33139
305 534-1949
Line: audio equip
Inovonics see ad pg 124

GRA-MAR INC

3165 McCrory Pl
Orlando
Line: audio equip
Modular Audio see ad pg 90

HARMON IND INC

3134 Cleveland Ave
Fort Myers 33901
813 936-4168
Line: video equip
Viscount see ad pg 152

HARRIS AUDIO SYSTEMS INC

1962 NE 149th St N
Miami 33181
305 944-4448
Line: full line audio equip
Inovonics see ad pg 124

GALEN HASSINGER

306 Smokerise Blvd
Longwood 32750
305 862-1812
Line: broadcast equip
Harris see ad pgs 12, 32, 127

IVEY COMMUNICATIONS

744 W Church St
Orlando 32805
305 423-8299
Line: video equip
ISI see ad pg 83

LAUDERDALE ELECTRONICS LABS

16 SW 13th St
Ft Lauderdale 33315
305 764-7755
Line: audio components
ESE see ad pg 183

LEE FLORIDA INC

PO Box 672
Winter Haven 33880
813 294-5815
110 Algonquin Terrace
Indian Harbor Beach 32937
305 773-8114
Line: full line broadcast equip
Marconi see ad pg 120

MIDWEST TELECOMMUNICATIONS

3331 NW 82nd Ave
Miami 33122
305 592-5355
Line: audio & video equip, lighting equip
Anton/Bauer see ad pg 93
Conrac see ad pg 136
ISI see ad pg 83

PHOTOMART

6237 S Orange Ave
Orlando 32809
305 851-2780
Line: video equip, lighting equip
Frezzolini see ad pg 132

RADFORD ASSOC

3203 Lanier Dr
Atlanta GA 30319
404 237-6097
Line: television equip
Asaca see ad pg 59

IVEY RAULERSON

PO Box 958
MacClenny 32063
904 259-6475
Line: broadcast equip
Harris see ad pgs 12, 32, 127

REPELECT

Box 7102 8406 N Blvd
Tampa 33604
813 227-5051
Line: audio & video equip
Ramko see ad pgs 28-29, 154-155
TFT see ad pg 151

REYNOLDS & ASSOC

476 North A1A-Suite 1A
Satellite Beach 32937
305 773-4700
11405 8 St E Treasure Island
St Petersburg 33706
813 360-1484
161 SW 75 Ave
Ft Lauderdale 33317
305 581-6611
Line: audio components
Allen Avionics see ad pg 145

R & H ASSOC

PO Box 364
Safety Harbor 33572
813 535 2455
Line: broadcast equip
NEC see ad pg 81

SOUTHEAST ELECTRONICS

1125 Rouselle St
Jacksonville 32203
904 356-3007
Line: full line of audio/video equip

THIRD CENTURY MKTG

2800 W Sheridan St
Hollywood 33021
305 947-7107
Line: audio equip
dbx see ad pg 99

GEORGIA

BCA

PO Box 2606 312 Hwy 74 S
Peachtree 30269
404 487-9559
Line: audio, RF, test equip
Elcom see ad pg 152

GEORGE BIRX

Stones mountain
404 891-5465
Line: video equip
Anvil Cases see ad pg 84

BROADCAST COMM ASSOC

PO Box 2606
Peachtree City 30264
404 487-9559
Line: audio & RF equip
Inovonics see ad pg 124
LPB see ad pg 170
UMC see ad pg 150

ELECTRO ACOUSTIC SYSTEMS

1093 Blvd
Athens 30601
404 353-1283
Line: audio equip
ADR see ad pg 130

ELECTRONIC EQUIPMENT INC

526 Plaster Ave NE
Atlanta 30324
404 873-5841
Line: audio components & equip
Conrac see ad pg 136
ISI see ad pg 83

EME II INC

2522 Tanglewood Rd
Decatur 30033
404 325-0165
Line: broadcast equip
NEC see ad pg 81
TFT see ad pg 151

FIDELICOM INC

PO Box 80644
Chamblee Station

Atlanta 30341

404 458-3616
3115 Marjan Dr
Doreville 30340
Line: audio equip, test equip
Otari see ad pg 63

PAUL FLETCHER

2971 Flowers Rd S #160
Atlanta 30341
404 457-1266
Line: video equip
MCI/Quantel see ad pg 101

FM ASSOC LTD

PO Box 9901 30319
2060 Peachtree Ind Ct
Atlanta 30341
404 451-2293 or 452-1535
Line: broadcast components
Lightning Elimination see ad pg 100

GRAY COMMUNICATIONS

1709 Stuart Ave
Albany 31755
912 435-8386
404 Sands Dr
Albany 31706
912 883-2121
3684 Clearview Pky
Doraville 30340
404 455-3121
Line: audio & video equip, video systems
Anton/Bauer see ad pg 93
Ikegami see ad pgs 15, 143
ISI see ad pg 83
Arvin/Echo see ad pg 139

ROGER HARVEY

Atlanta
404 447-7000
Line: video equip
3M Video see ad pgs 56, 117

PAT HUBBARD

1900 Emery St NW
Atlanta 30318
404 491-1549
Line: video equip
Compact Video see ad pg 162

MICRO CONSULTANTS INC

2971 Flowers Rd S Ste #106
Atlanta 30341
404 457-1266
Line: video equip
MCI/Quantel see ad pg 101

RADFORD ASSOCS

3203 Lanier Dr
Atlanta 30319
404 237-6097
Line: full line broadcast equip
Asaca see ad pg 59
Datatek see ad pg 179
Knox see ad pg 98

REYNOLDS & ASSOC INC

5057 Vernon Springs Dr
Atlanta 30338
404 393-9113
Line: video equip
Allen Avionics see ad pg 145

ROSCOM INC

PO Box 1208
Roswell 30077
404 992-2770
Line: audio equip
ESE see ad pg 183
Inovonics see ad pg 124
Ramko see ad pgs 28-29, 154-155
TFT see ad pg 151

SPHERE AUDIO SALES

6985-B Roswell Rd NE
Atlanta 30328
404 393-9474
Line: full line audio equip
BTX see ad pg 176

TECHNICAL INDUSTRIES

6000 Peachtree Rd
Atlanta 30341
404 455-7610

Line: video equip
ISI see ad pg 83
Clear/Com see ad pg 146

VISUAL SYSTEMS

3870 N Peachtree Rd
Atlanta 30341
404 457-1388
Line: video equip
ISI see ad pg 83

WILSON AUDIO SALES

6985 B Roswell Rd NE
Atlanta GA 30328
404 393-9474
Line: audio equip
BTX see ad pg 176

HAWAII

ALOHA ASSOC

1750 Kalahaua Ave Ste 1302
Honolulu 96826
808 941-1574 or 941-1575
Line: broadcast components
Lightning Elimination see ad pg 100

AUDISSEY

679 Auahi St
Honolulu 96813
808 521-6791
Line: audio equip
ADR see ad pg 130
Clear/Com see ad pg 146

BROADCAST SERVICES INC

2877 Kalakaua Ave
Honolulu 96815
808 521-6311
Line: audio & RF equip
Ramko see ad pgs 28-29, 154-155
UMC see ad pg 150

EMC CORP

Dave Caldwell
2979 Ualena St
Honolulu 96819
808 836-1138
Line: video & test equip
Arvin/Echo see ad pg 139
Knox see ad pg 98

JOHN J HARDING CO LTD

2825 Valena St
Honolulu 96819
808 836-0941
Line: broadcast equip
Inovonics see ad pg 124

JC ELECTRONICS

PO Box 27185
Honolulu 96827
808 836-3449
Line: audio equip

NORTHSHORE MARKETING

15084 NW 65 St
Redmond WA 98052
Line: audio equip
Otari see ad pg 63

JIM WALTERS CO

5017 Kalanainaole Hwy
Honolulu 96821
808 373-2701
Line: audio equip
Ramko see ad pgs 28-29, 154-155

IDAHO

AMERICAN MEDIA SUPPLY CO

134 E Main St
Rexburg 83440
Line: audio equip
UMC see ad pg 150

HALL ELECTRONICS

2802 Kootenai St
Boise 83705
208 336-5894
Line: audio equip
Ramko see ad pgs 28-29, 154-155

Telemet

has a new video D.A.*!
 plus,—a few other
Broadcast and Telecommunications products.

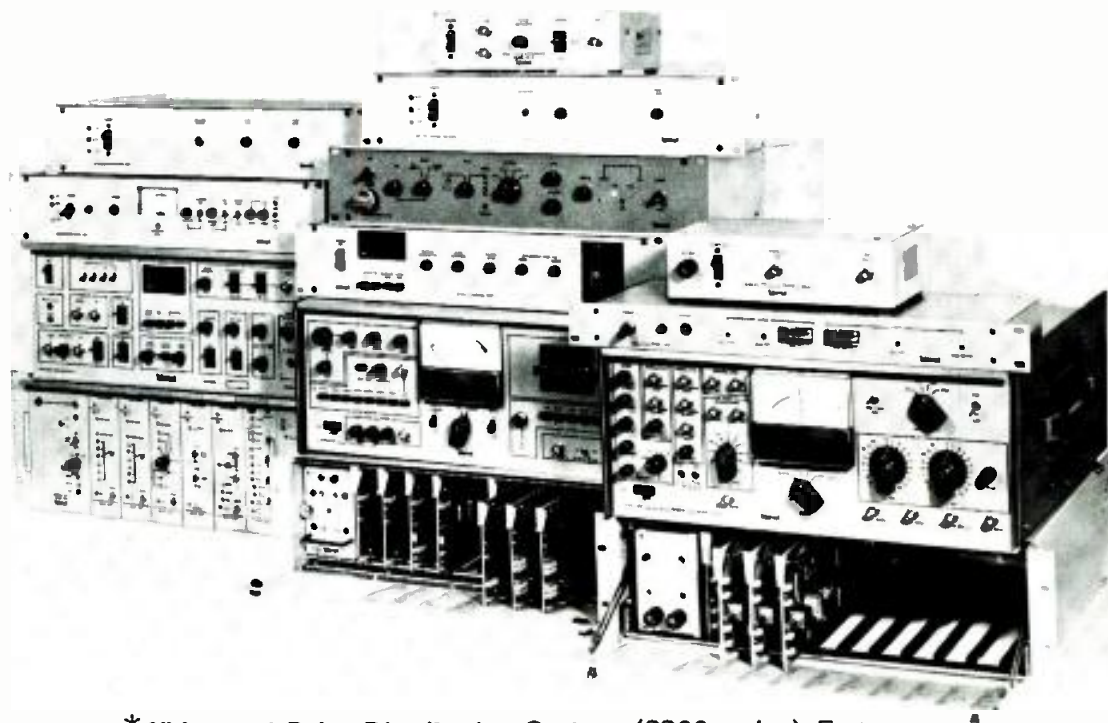

* **Video and Pulse Distribution System, (3300 series).** Features Video DA's with frequency equalization; Pulse DA's with variable delay.

Envelope Delay Measurement Set, 3705 measures the envelope delay of video frequencies for compliance with FCC requirements.

Sideband Analyzer, 3706 shows with a calibrated response curve if sideband attenuation and frequency response meet FCC requirements. (model 3709, for deeper resolution and spectrum analysis).

Broadcast Demodulator, 4501 accurately demodulates the transmitted signal to show the true video signal being broadcast.

Demod Tester, 4503-A1 quickly checks the broadcast signal demodulator for flatness of frequency response.

Modulator, 4420 is a state of the art cable TV modulator with VSB saw filter, digital display, very low noise and FCC TV transmitter specs.

Broadcast Demodulator, 3710 is a comprehensive demodulator with both synchronous and envelope detection, built-in self tester, digital display, multiplexed outputs and other convenience features.

Clamper Amplifier, 3203-F clamps high levels of hum on balanced and unbalanced lines. Equalizes for cable loss up to 10 dB.

Fiber Optics Video Transmission System, 4210 has audio sub-carrier. Provides interference-free video and aural transmissions for STL and ENG applications.

Modular Test Set, 3538 provides up to 8 EIA standard video test signals. Special purpose modules also available.

Audio DA System, 6910. Each DA card provides 6 balanced, or 12 unbalanced 600 ohm outputs. 10 cards per frame with power supply.

Dual Trace Converter, 4510. Electronically switches 2 video signals to provide separated simultaneous displays on single trace scope.

Isolation Amplifier, 5300. An active device that negates hum caused by ground loops on unbalanced video transmission cable.

Over 175 products and accessories available

Telemet

A Geotel Company

185 Dixon Avenue, Amityville, L.I., New York 11701 (516) 842-2300 TWX 510-227-9850

Circle 227 on Reader Service Card

Reps/Dists

Idaho continued

THOMAS HILL BDCST CONSULTANTS

1300 Hill Rd
Boise 83702
208 342-6902
Line: audio equip
Ramko see ad pgs 28-29, 154-155

ILLINOIS

ALEXANDER BATTERY

Palatine
425 S Elm St 60067
312 359-1075
Line: broadcasting equip
Alexander see ad pg 112

ALL MEDIA SALES CO

1535 Foxhill Rd
Naperville 60540
312 628-0840
Line: video equip
Knox see ad pg 98

ANCHA ELECTRONICS

189 Gordon Street
Elk Grove Village 60007
312 437-7712
Line: audio/video equip
ISI see ad pg 83
Clear/Com see ad pg 146

AUDIO RESOURCES

825 N Kass Ave Ste 15
Westmont 60559
312 655-1180
Line: audio equip
dbx see ad pg 99
Otari see ad pg 63

BSC INC

2932 River Rd
River Grove 60171
312 452-5551
Line: audio equip

CENTER VIDEO CENTER

5800 W Fullerton Ave
Chicago 60639
312 637-1600
Line: video equip
ISI see ad pg 83

COMMUNICATIONS SYSTEMS

Drawer C
Cape Girardeau MO 63701
314 334-6097
Line: audio, RF, test equip
Elcom see ad pg 152

CHARLES COYLE

16 Stonehearth Ln
Indianhead PK 60525
312 246-0666, 7304
Line: broadcast equip
Harris see ad pgs 12, 32, 127

DOUG CURRY

PO Box 1108
Burnsville MN
612 894-3047
Line: video equip
Anvil Cases see ad pg 84

VICTOR DUNCAN INC

200 E Ontario
Chicago 60611
312 321-9406
Line: full line video, film,
lighting equip
Clear/Com see ad pg 146
Victor Duncan see ad pg 149

ELECTRO-TECH MARKETING ASSOC

3525 W Peterson Ave
Chicago 60659
312 588-4535
Line: video equip
Allen Avionics see ad pg 145

GO VIDEO SALES

1195 S Wilson
Lake Frest 60045
312 295-6726
Line: video equip
Knox Video see ad pg 98

PHIL HALTER

Chicago
815 455-6723
Line: video equip
3M Video see ad pgs 56, 117

DWIGHT HERBERT

100 E Ohio St
Chicago 60611
800 621-6836
Line: full line bdcst equip
Broadcast Controls see ad pg 148

RAY R HUTMACHER ASSOC INC

1014 Busse Hwy
Park Ridge 60068
312 692-5570
Line: audio components,
communications equip, tape recorders
Eumig see ad pg 185

MCCURDY RADIO IND INC

1711 Carmen Dr
Elk Grove Village 60007
312 640-7077
Line: professional broadcast equip
McCurdy see ad C3
Aristocart see ad pg 168
UMC see ad pg 150

MEADE ELECTRONICS CO INC

3100 S 25 St
Broadview 60153
312 344-4174
Line: audio components
BTX see ad pg 176
Conrac see ad pg 136

KENNETH MEYERS

7442 N Harlew
Chicago 60648
312 882-4808
1242 Remington Rd
Schaumburg 60195
312 882-4808
Line: full line & video equip
Marconi see ad pg 120

MIDWEST BROADCAST SUPPLY

612 N Michigan Ave Ste 507
Chicago 60611
Line: professional broadcast equip
LPB see ad pg 170
UMC see ad pg 150

MILAM AUDIO CORP

1504 N 8 St
Pekin 61554
309 346-3161
Line: audio components, equip:
recorders
ADR see ad pg 130

NOMAD ENGINEERING

466 Central Ave Ste 28
Northfield 60093
312 446-2725
Line: broadcast components
Lightning Elimination see ad pg 100

THEODORE PAPPAS ASSOC

5218 W Diversey Ave
Chicago 60639
312 685-2338
Line: audio equip
Otari see ad pg 63

RICK PARENT

Columbus OH
614 890-8623
Line: video equip
Anvil Cases see ad pg 84

ROSCOR CORP

6160 W Oakton St
Morton Grove 60059
312 539-7700
Line: full line video equip
Ikegami see ad pgs 15, 143
ISI see ad pg 83

DICK SMITH

3N 424 Mulberry Dr
West Chicago 60185
312 293-1568
Line: video equip
Compact Video see ad pg 162

SWIDERSKI ELECTRONICS

1200 Greenleaf Ave
Elk Grove Village 60007
312 364-1900
Line: audio & video equip,
lighting equip
Conrac see ad pg 136
Arvin/Echo see ad pg 139
Gray Engineering see ad pg 180

STUDIO ELECTRONICS

3252 W Foster
Chicago 60625
312 478-2050
Line: full line of audio & lighting equip
Inovonics see ad pg 124

BRIAN TUCKER

111 S Dr Tower Lake
Barrington 60010
312 381-4559
Line: audio equip
Studer Revox see ad pg 89

VIDEO MASTERS INC

119 Church St Ste 131
St Louis MO 63135
314 524-1311
Arvin/Echo see ad pg 139

INDIANA

ALLIED BROADCAST EQUIP

PO Box 786 635 S E St
Richmond 47374
317 962-8596
Line: audio equip for radio
Aristocart see ad pg 168
ESE see ad pg 183
Hallikainen see ad pg 140
Inovonics see ad pg 124

AUDIO DISTRIBUTORS INC

2342 S Division Ave
Grand Rapids MI 49507
616 452-1596
Line: audio, RF & test equip
Elcom see ad pg 152

AUDIO RESOURCES

825 N Cass Ave
Westmont IL 60559
Line: audio equip
Otari see ad pg 63

CENTURY DYNAMICS INC

PO Box 15483 4704 Colbran Ct
Fort Wayne 46815
219 486-2681
Line: broadcast components
Lightning Elimination see ad pg 100

HM DYER

31185 Ten Mile Rd
Framington Hills MI 48024
313 478-2157
Line: video equip
Asaca see ad pg 59

ELECTRONIC SYNERGY INC

4858 N 13 St
Terre Haute 47805
812 466-6868
5335 N Tacoma Ste 20
Indianapolis 46220
317 251-0800
Line: full line of video equip
ISI see ad pg 83

BOB HOKE SALES INC

56 Belair Dr
Huntington 46750
219 356-1555
Line: audio equip
Eumig see ad pg 185

KLOPF AUDIO/VIDEO CO

1011 Merchants Barik Bldg
Indianapolis 46204
417 926-3919
Line: broadcast equip
Arvin/Echo see ad pg 139
ISI see ad pg 83
Clear/Com see ad pg 146

KENNETH MEYERS CO

3512 Rockville Rd
Indianapolis 46222
317 243-6681
Line: test equip TV & radio equip
Marconi see ad pg 120

RICK PARENT

Columbus OH
614 890-8623
Line: video equip
Anvil Cases see ad pg 84

JIM SPERANDO

701 Neim
Zionsville 46077
317 763-9197
Line: broadcast equip

IOWA

CENTURIAN MARKETING

Box 1011/124 Manchester Rd
Blaawin MO 63011
314 227-7229
Line: audio equip
Otari see ad pg 63

CDP INDUSTRIES

801 Hwy 67 Box 115
Ashippun WI 53003
414 474-4112
Line: video equip
Asaca see ad pg 59

DOUG CURRY

PO Box 1108
Burnsville MN
612 894-3047
Line: video equip
Anvil Cases see ad pg 84

ENTERPRISES INC

6001 N 91 St
Milwaukee WI 53225
414 358-1007
Line: audio, RF, test equip
Elcom see ad pg 152

SMI CO

1138 37 St
Des Moines 50311
Line: broadcast components
Lightning Elimination see ad pg 100

TODD COMMUNICATIONS

7360 Ohms Ln
Minneapolis MN 55435
612 835-3080
Arvin/Echo see ad pg 139

KANSAS

CENTREX AUDIO VISUAL SYSTEMS

210 W 6 St
Topeka 66603
913 232-7701
Line: audio & video equip
ISI see ad pg 83

CENTURION MARKETING

Box 1011/124 Manchester Rd
Blaawin MO 63011
314 227-7229
Line: audio equip
Otari see ad pg 63

RON FRILLMAN

6617 Hallett
Shawnee Mission 66216
913 631-8293
Line: video equip
MCI/Quantel see ad pg 101

Reps/Dists

Kansas continued

JIM GRUNDER
8812 Santa Fee Ln
Overland Park 66212
913 831-0188
Line: video equip
Knox see ad pg 98

MICRO CONSULTANTS INC
6617 Hallet
Shawnee Mission 66216
913 631-8293
Line: video equip
MCI/Quantel see ad pg 101

TELEVISION ENGINEERING CORP
8330 Reinhardt Dr
Prairie Village 66206
913 642-8011
Line: video equip
Ikegami see ad pgs 15, 143

VIDEO MASTERS INC
1820 Wyandotte
Kansas City 64108
816 474-8530
1616 Broadway POB 1963
Kansas City 64141
816 474-8530
Line: full line video lighting equip
Arvin/Echo see ad pg 139

KENTUCKY

AUDIO RESOURCES
825 N Cass Ave Ste 205
Westmont IL 60559
Line: audio equip
Otari see ad pg 63

BRUCK L DAWSON & ASSOCIATES
PO Box 114
Prospect 40059
502 228-4898
Line: video equip, cameras, lenses
Knox see ad pg 98
NEC see ad pg 81

ELECTRONIC LABS INC
800 S 4 St
Louisville 40203
502 583-2312
Line: audio & video equip
Inovonics see ad pg 124

RALPH HUCABY
1331 Otter Creek Rd
Nashville TN 37215
615 373-0231
Line: video equip
Asaca see ad pg 59

KLOPF
New Albany IN
812 945-9008
Arvin/Echo see ad pg 139

MIDWEST TELECOMMUNICATIONS
1804 Cargo Ct
Louisville 40299
502 491-2888
Line: video equip
Ikegami see ad pgs 15, 143
ISI see ad pg 83
Clear/Com see ad pg 146

WALTER B RICE
PO Box 90
Prospect 40059
502 228-0000
Line: broadcast equip
Harris see ad pg 12, 32, 127

SONIC SERVICES
818 Grade Lane
Louisville 40213
502 367-2823
Line: audio & recording equip
Inovonics see ad pg 124

LOUISIANA

AUDIOMEDIA ASSOCS
PO Box 29264
New Orleans 70189
504 242-8104
Line: audio components, radio transmitters
Inovonics see ad pg 124
LPB see ad pg 170

JAMES BRINDLE
500 Lake Marina Ave
New Orleans 70124
504 288-8050
Line: broadcast equip
Harris see ad pgs 12, 32, 127

GRAY COMMUNICATIONS
5441 Pepsi St
New Orleans 70123
504 733-7265
910 N Bon Marche Ste E
Baton Rouge 70806
504 733-7265, 924-2298
Line: video equip
Anton/Bauer see ad pg 93
Arvin/Echo see ad pg 139
Ikegami see ad pgs 15, 143
ISI see ad pg 83

PAUL KADAIRES INC
4773 Convention St
Baton Rouge 70806
504 924-1001
Line: audio equip
ADR see ad pg 130

MZB & ASSOC
440 No Foster Dr
Baton Rouge 70806
504 926-8287
Line: audio equip
Ramko see ad pgs 28-29, 154-155

CORY MYERS
4657 Michoud Blvd Ste 5
New Orleans 70129
504 586-0140
Line: full line bdcst equip
Broadcast Controls see ad pg 148

GENE SUDDUTH CO
845 39 St SE
Paris TX 75460
214 785-5764
Line: video equipment
Asaca see ad pg 59

TENICKI
6432 Wastchester
Houston TX 77005
713 663-6432
Line: audio equip
Otari see ad pg 63

MAINE

JIM BOLDEBROOK
RFD #3
Gorham 04038
207 929-6736
Line: broadcast equip
Cetec see ad pg 76

GMI
181 Worchester Rd Rt 9
Natick MA 01760
617 237-6544
Line: audio equip
Otari see ad pg 63

PROFESSIONAL VIDEO SYSTEMS
1616 Soldiers Field Rd
Boston MA 02135
617 254-2101
Arvin/Echo see ad pg 139

Combined 2" & 1" Video Tape Cleaner Video Tape Evaluator

Recortec now offers a practical solution to broadcasters faced with a transition in tape standards: a cleaner or evaluator usable for both 2-inch and 1-inch tape.

Recortec's VTC-210 tape cleaner is two machines in one. Conversion takes less than five minutes and can be made by an operator. The work is all done at the front of the machine and requires no tools.

Similarly, the VTE-210 tape evaluator is just as easy to use and easy to convert. It takes less than five minutes for mechanical change and requires no electrical adjustment. The evaluator comes with a new microprocessor-controlled printer which tallies all defects for each tape.



If you've never owned a Recortec cleaner or evaluator, there's no better time to buy one. For immediate reply, please call Sid McCollum, National Sales Manager for additional details.

RECORTEC, INC. 475 Ellis Street, Mountain View, CA 94043 Tele: (415) 962-0220 TWX: 910-379-5022

Circle 229 on Reader Service Card

Reps/ Dists

Maine continued

STEVE THACHER
Fishkill NY
914 896-5860
Line: video equip
Anvil Cases see ad pg 84

MARYLAND

ASSOCIATED SALES REPS
403 Fieldstone Ct
Fallstone 21047
301 877-7300
Line: audio equip
Otari see ad pg 63

GENE BIDUN & ASSOC
PO Box 861
Columbia 21044
301 992-4444
10729 Midsummer Ln
Columbia 21044
202 342-3946
Line: RF equip
Cetec see ad pg 76
Harris see ad pgs 12, 32, 127
Inovonics see ad pg 124

COMMERCIAL VIDEO REPS
2637 N Charles St
Baltimore 21218
301 235-9120
Line: video equip
Knox see ad pg 98

HAYDEN ASSOC
16 Decatur Ave
Annapolis 21403
202 296-6059
Line: broadcast equip
TFT see ad pg 151

MIDWEST TELECOMMUNICATIONS
4700-G Boston Way
Lanham 20801
301 577-4903
Line: audio & video equip
Conrac see ad pg 136
ISI see ad pg 83

NEFF COMMUNICATIONS
9721 Singleton Dr
Bethesda 20034
301 530-6080
Line: audio equip
Ramko see ad pgs 28-29, 154-155

PIERCE PHELPS INC
10215 Fernwood Rd Ste 15
Bethesda 20034
301 530-9580
Line: full line video equip, lighting equip
ADDA see ad pg 3
Ikegami see ad pgs 15, 143

RON PHENICIE
Danville PA
717 275-7900
Line: audio equip
Anvil Cases see ad pg 84

PROFESSIONAL PRODUCTS INC
4964 Fairmont Ave
Bethesda 20014
301 657-2141
Line: full line video products, lighting equip
Arvin/Echo see ad pg 139
ISI see ad pg 83

RECORDING CONSULTANTS INC
8550 2nd Ave
Silver Springs 22910
301 587-1800
Line: full line of audio equip
Inovonics see ad pg 124
Clear/Com see ad pg 146

S&S ASSOCS
4924 Hampden Lane
Bethesda 20014
301 654-1434
Line: test instruments
Marconi see ad pg 120

DWIGHT WILCOX
16850 Oakmont Ave
Washington Grove MD 20880
301 258-7676
Line: video equip
American Data see ad pg 24

WILTRONIX INC
16850 Oakmont Ave
Washington Grove 20880
301 258-7676
Line: broadcast equip & access
NEC see ad pg 81
TFT see ad pg 151

WS WARRINGTON & ASSOC
PO Box 313
Riderwood 21139
301 823-8759
Line: audio equipment

WRIGHT CO INC
19104 Rhodes Way
Gaithersburg 20760
301 840-1928
Line: video equip
Allen Avionics see ad pg 145

MASSACHUSETTS

APPLIED MEASUREMENTS INC
PO Box 316 77 Great Rd
Acton 01720
617 263-2766 or 646-7250
Line: broadcast components
Lightning Elimination Assoc see ad pg 100

CHAMBERLIN & MURRAY
336 Baker Ave
Concord 01742
617 369-8013
Line: audio equip
Elcom see ad pg 152
Ramko see ad pgs 28-29, 154-155

CRAMER VIDEO
120 Hampton Ave
Needham 02194
617 449-2100 or 800-225-3768
Line: video equip

EASTERN BROADCAST SUPPLY
46 Mechanic St
Leominster 01453
617 537-4706
Line: broadcast equip
UMC see ad pg 150

DAVE FOLSOM
25 Pratts Mill Rd
Sudbury 01776
617 443-5708
Line: video equip
Ikegami see ad pgs 15, 143

GEDER ASSOC
PO Box 307 34 Pasture Rd
Reading 01867
617 944-3105
Line: RF equip
Electro Impulse see ad pg 177

GMI
181 Worchester Rd Rt 9
Natick 01760
617 237-6544
Line: audio equip
Otari see ad pg 63

ETHAN HARRIS
265 Foxridge
Marshfield 02050
617 834-4388
Line: video equip
Cetec see ad pg 76

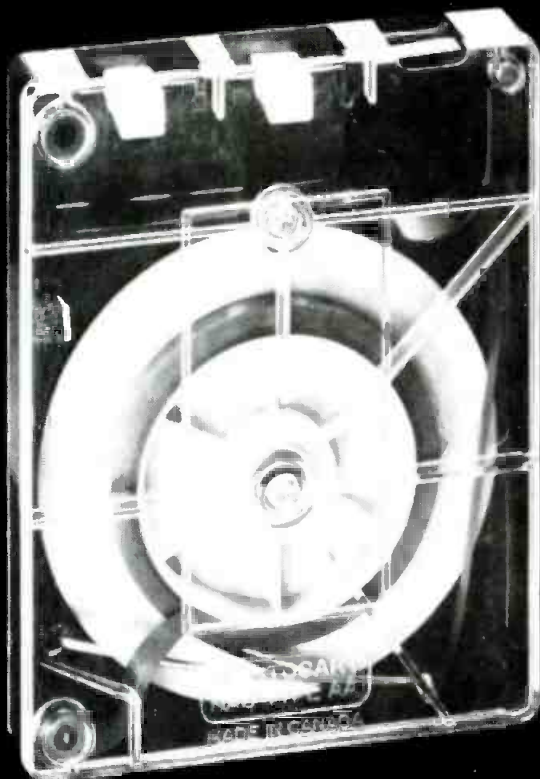

NAB TYPE AA Cartridge
manufactured by
ARISTOCART DIV. WESTERN BROADCASTING LTD.
505 BARRARD ST. VANCOUVER, CANADA V7X 1M6
TEL: (604) 687-2844 TELEX: 04-54639

CONVERTING TO AM STEREO?

*this cartridge will deliver
all the sound you're paying for.*

ARISTOCART is the choice of leading FM stations in America's major cities — the standard by which all other broadcast cartridges are judged. Since 1975, it has consistently exceeded NAB specifications — the only commercial cartridge to do so.

ARISTOCART is manufactured from engineering grade polycarbonate in a single cavity precision moulding process; each cartridge is individually checked for phase and frequency response plus mechanical operation.

On properly aligned equipment we guarantee performance. Or we replace at our expense.

ARISTOCART

The cartridge for people who care how they sound

Circle 230 on Reader Service Card

Reps/Dists

INDUSTRIAL COMPONENTS CORP
2551 Boston Rd
N Wilbraham 01067
413 596-3854
Line: audio components
Clear/Com see ad pg 146

KEN CORP
38 Montvale Ave
Stoneham 02180
617 926-5525
Line: test instruments
Marconi see ad pg 120

LAKE SYSTEMS CORP
55 Chapel St
Newton 02160
617 244-6881
Line: full line audio, video & lighting
equip
ADDA see ad pg 3
CEI see ad pg 105
Clear/Com see ad pg 146
ISI see ad pg 83

LEBOW LABS
424 Cambridge St
Allston 02134
617 782-0600
Line: full line audio & video equip
Inovonics see ad pg 124
ISI see ad pg 83

NEREM
64 Whittier Rd
Wakefield 01880
Line: audio equip
Modular Audio see ad pg 90

NEW ENGLAND MARKETING GROUP
Ayer Rd
Harvard 01415
617 456-3392 or 617 456-8284
Line: audio equip
Eumig see ad pg 185

PROFESSIONAL AUDIO ASSOCS
75 N Beacon St
Watertown 02172
617 926-6107
Line: audio equip
dbx see ad pg 99

PROFESSIONAL VIDEO SYSTEMS INC
1616 Soldier's Field Rd
Boston 02135
617 254-2101
Line: full line video equip
Arvin/Echo see ad pg 139
NEC see ad pg 81
Rohde & Schwarz see ad pgs 13, 184

QSI SYSTEMS INC
993 Watertown St
W Newton 02165
617 969-7118
Line: audio & video equip
Conrac see ad pg 136

JOHN RING & ASSOC
Box 188
East Hampton 01027
413 527-4430
Line: RF equip
Hallikainen & Friends see ad pg 140

RING ASSOC INC
Box 188
Easthampton 01027
413 527-4430
Line: broadcast equip
Inovonics see ad pg 124

STEVE THACHER
Fishkill NY
914 896-5860
Line: video equip
Anvil Cases see ad pg 84

F M VALENTI
16 Saddle Club Rd
Lexington 02173
617 861-0089
Line: audio equip, video equip, camera
lenses

V F SALES, INC
181 Worcester Rd
Route #9
Natick 01760
617 237-6544
Line: audio & video products
Otari see ad pg 63

WAYLAND ENGINEERING SALES
2 Evergreen Rd
Natick 01760
617 655-6080
Line: video equip
Allen Avionics see ad pg 145

MICHIGAN

AUDIO DISTRIBUTORS
232 4 Division Ave S
Grand Rapids 49507
616 452-1596
Line: full line of radio, RF equip
Clear/Com see ad pg 146
Elcom see ad pg 152
ESE see ad pg 183
Inovonics see ad pg 124
LPB see ad pg 170
UMC see ad pg 150

CHAMPAGNE SALES CO
10861 W 10 Mile Rd
Oak Park 48237
313 398-6930
Line: audio equip
Ramko see ad pgs 28-29, 154-155

C M SALES
2221 Lakeshore
W Bloomfield 48033
313 626-2397
Line: audio equip
Otari see ad pg 63
dbx see ad pg 99

VICTOR DUNCAN INC
11043 Gratiot Ave
Detroit 48213
313 371-4920
32380 Howard
Madison Hqts 48071
313 589-1900
Line: photo supplies & equip, lighting
equip
Clear/Com see ad pg 146
Victor Duncan see ad pg 149

H M DYER ELECTRONICS
31185 Ten Mile Rd
Farmington Hills 48024
313 343-4300; 478-2157
Line: full line broadcast equip
ADDA see ad pg 3
Asaca see ad pg 59
Datatek see ad pg 179
Knox see ad pg 98
Skotel see ad pg 108
TEA see ad pgs 148, 186, 199
TFT see ad pg 151
Clear/Com see ad pg 146

RALPH HUCABY
1331 Otter Creek Rd
Nashville TN 37215
615 373-0231
Line: video equip
Asaca see ad pg 59

Reliability that's in a class by itself. The Sintronic SI-F-25.

The Sintronic 27.5 kilowatt FM Broadcast Transmitter uses zero-bias, grounded-grid triode tubes in both the driver and power amplifier. These stages do not require neutralization, nor are grid-bias or screen-grid power supplies needed. Individual 12-pulse, high voltage supplies power both the driver and power amplifier. The result is a marked reduction in the number of components and a strikingly clean electromechanical design.

Other than its external coaxial harmonic filter, the SI-F-25 is completely self-contained in a dual section cabinet. Each section includes its own overload protection, automatic three-cycle recycling, automatic power output control and critical circuit monitoring. In the event of failure in the PA, the SI-F-25 is capable of cutback to the 3.5 kW output of the driver using optional output coaxial switching.

The high level triode design of our SI-F-25 yields superior broadband characteristics essential to optimum stereo performance. This design, enhanced by overall circuit simplicity and carefully selected components, results in a transmitter whose stability and reliability set it in a class by itself.

The Sintronic SI-F-25... an outstanding transmitter. Equally outstanding FM transmitters are available at 1.5, 3.5, 5.5, 17.5 and 55 kW output levels. For complete information, write or call the factory.

The Sound Source **Sintronic**
CORPORATION
212 Welsh Pool Road, Lionville, PA 19353 (215) 363-0444

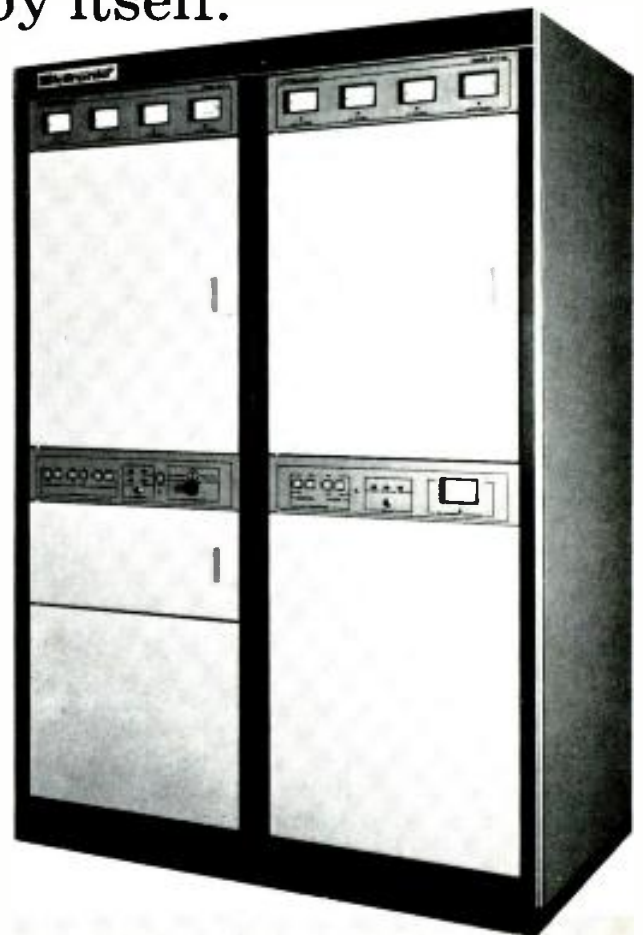

Reps/ Dists

Michigan continued

R P HERMES CO

9600 Whittier St
Detroit 48224
313 886-4566
Line: audio & video equip
Conrac see ad pg 136

DAVE HILL

7641 19 Mile Rd
Sterling Heights 48077
313 739-7020
Line: broadcast equip
Cetec see ad pg 76

KLOPF

Detroit
517 792-0076
Arvin/Echo see ad pg 139

ROBERT MILSK CO

22420 Telegraph Rd
Southfield 48037
313 354-3310
Line: video equip
Knox see ad pg 98

RICK PARENT

Columbus OH
614 890-8623
Line: video equip
Anvil Cases see ad pg 84

R.B. SALES

617 E S Holly Rd
Frenton 48430
313 629-3613
Line: audio equip
Eumig see ad pg 185

THOMAS G SCHOONOVER

1802 Cottonwood
Holt 48842
517 694-1223
Line: broadcast equip
Harris see ad pgs 12, 32, 127

WAYNE SCHULER

11100 Harry Court
Brighton 48116
313 227-9675
Line: broadcast equip
Harris see ad pgs 12, 32, 127

SOUND SOLUTIONS INC

2791 E 14 Mile Rd
Sterling Heights 48077
313 739-7020
7641 19 Mile Rd
Sterling Heights 48079
313 739-7020
Line: audio equip
Clear/Com see ad pg 146
Hallikainen & Friends see ad pg 140
ADR see ad pg 130
NEC see ad pg 81

THALNER ELECTRONIC LABS

7235 Jackson Rd
Ann Arbor 48194
313 761-4506
Line: video equip
ISI see ad pg 83

THIBODEAU ENGINEERING

725 S Adams Ste L-1
Birmingham 48011
313 642-6620
Line: broadcast components
Lightning Elimination see ad pg 100

VF SALES INC

8244 Dear Creek Ln
Canton 48187
313 453-8720

869 South Main
Plymouth 48170
313 453-8720
Line: audio equip
Otarl see ad pg 63

WEBSTER & ASSOC

t55 Bellarmine Rochester 48063
800 521-2333
Line: broadcasting equip
Alexander see ad pg 112

MINNESOTA

AVC SYSTEMS INC

1517 E Lake St
Minneapolis 55407
612 729-8305
Line: broadcast equip
Inovonics see ad pg 124

CDP INDUSTRIES

801 Hwy Box 115
Ashippun WI 53003
414 474-4112
Line: video equip
Asaca see ad pg 59

DOUG CURRY

PO Box 1108
Burnsville
612 894-3047
Line: video equip
Anvil Cases see ad pg 84

EMMONS ASSOCS INC

1121 Riverwood Dr
Burnsville 55337
612 890-8920
10700 Lyndale Ave
Minneapolis 55420
612 881-1118

Line: full line audio & video equip
American Data see ad pg 24
TFT see ad pg 151
Conrac see ad pg 136
NEC see ad pg 81
TFT see ad pg 151

ENTERPRISES INC

6001 N 91 St
Milwaukee WI 53225
414 358-1007
Line: audio, RF, test equip
Elcom see ad pg 152

FRUEN & ASSOC

2800 W Rd
Wayzata 55391
621 475-2642
Line: audio equip
Eumig see ad pg 185

KEN HAUGEN & ASSOC

PO Box 864
Anoka 55303
612 421-3395
Line: video equip
Allen Avionics see ad pg 145

K&M ELECTRONICS

7360 Ohm Lane
Minneapolis 55435
612 835-3080
Line: full line audio & video equip
Clear/Com see ad pg 146

KNOX ASSOC INC

PO Box 8065 945 Lydia Dr
St Paul 55113
612 488-5402
Line: broadcast components
Lightning Elimination see ad pg 100

3 Models—6, 8 and 10 mixer dual stereo • Transformer Balanced Inputs and Outputs • 3 Inputs Per Mixer—internal pads allow mic/line selection on the same mixer • Two 4-Input Auxiliary Input Selectors—may be assigned to any mixer • Pre-fader Pushbutton Cue—in addition to normal CCW fader cue position • LED Status Indicators—color coded to aid in instant identification of function selectors • Momentary or Continuous Remote Control Contacts—internally selectable, also controls optional digital timer reset/start • Full Metering Capability—two meters standard, up to four meters and/or digital clocks and timers optionally available, all meters provided with LED peak indicators • Gain Selectable Microphone Preamps—provided with center tap access for phantom condenser microphone power, processor input/output port with buffer amplifier for outboard compressors, limiters, etc. • Programmable Muting Logic—internal pin-programmed matrix allows any selection of monitor and cue muting for the first five mixer positions • Pushbutton Aural Phase Test • Announcer's Microphone Intercom-Air Selector • Full Dual Channel Operation—
independent program and audition assignment pushbuttons • **Five Monitor Driver Outputs—**four muted, one non-muted • **All Mixers Switch-Selectable to Mono or Stereo • Ground-Plane Techniques Used Throughout for Increased RF Immunity • Selectable Internal or External Master Level Controls • Accessories and Options—**mono mixdown, high impedance (cassette) line input plug-ins, reference oscillator/line input plug-in, additional microphone input plug-ins, digital clock, digital timer, linear faders

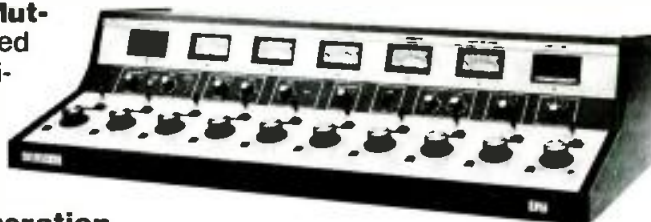

LPB® **citation series**
LPB Inc. • 28 Bacton Hill Road • Frazer, PA 19355 • (215) 644-1123
Manufacturers and Distributors of Broadcast Equipment since 1960
© 1980 LPB Inc

SELECT THE ROUTING SWITCHER YOU NEED



FROM ONE SOURCE...

di-tech



MODEL 5400
Matrix Sizes: 4x1, 8x2, 12x2,
or 3-4x1 or 4x3, AFV



MODEL 4412
Matrix 12x1 with dual audio.



MODEL 5000
Matrix from 16x2 to 28x2, AFV

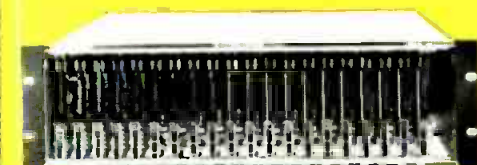

MODEL 5800*
Video Assembly expandable beyond 20x15*
Audio Assembly expandable beyond 20x15*



MODEL 5800*

di-tech knows your needs aren't the same as every other broadcaster, so when we build equipment like audio and video routing switchers we build a whole line of them. That way you can select the exact matrix size and mechanical configuration that meets YOUR requirements, for audio only, video only or audio-follow-video with 1, 2 or 3 channels of audio per input. So why settle for less when you can select di-tech's surprisingly affordable equipment custom-tailored to your needs?

Whether the application be for a radio or television station, mobile vans, remotes or unattended sites, di-tech has equipment for you.

- VIDEO PRESENCE DETECTORS
- TOUCH TONE SYSTEMS
- A/V ROUTING SWITCHERS
- AUDIO MONITOR AMPLIFIERS
- TRANSMISSION LINE SUPERVISION SYSTEMS
- A/V PULSE DISTRIBUTION AMPLIFIERS
- COMPUTERIZED REAL-TIME WEEKLY EVENT CONTROLLERS.

Call or write for more information or our FREE catalog today!

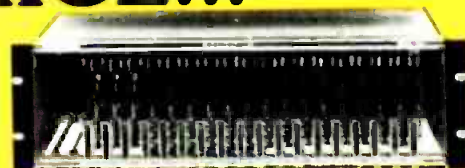

MODEL 5015
Matrix 20x7, AFV with up to 2 channels of audio per input.

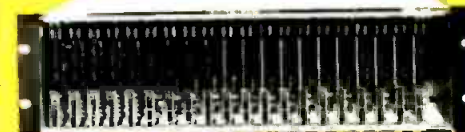

MODEL 5006
Matrix 20x6, AFV with up to 3 channels of audio per input.

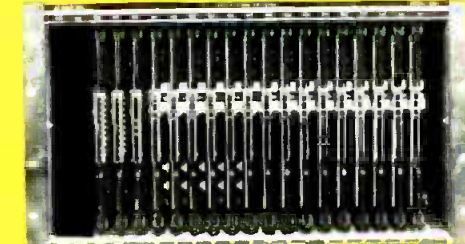
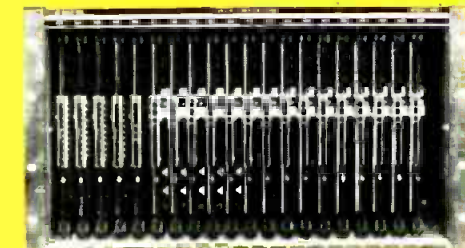

MODEL 5846*
Video Assembly expandable beyond 40x15*
Audio Assembly expandable beyond 40x15*

*Both **MODEL 5400** and **5800** feature:

- up to 3 channels of audio per input within the same frame
- expandable inputs and outputs beyond the stated matrix
- audio only, video only or AFV; V.I. switching

Discover for yourself why industry leaders are switching to di-tech!

di-tech

311 WYANDANCH AVENUE
NORTH BABYON, N.Y. 11704
Tel. # (516) 643-4040

Another Revolutionary Switcher from VITAL: the **250 P/N**

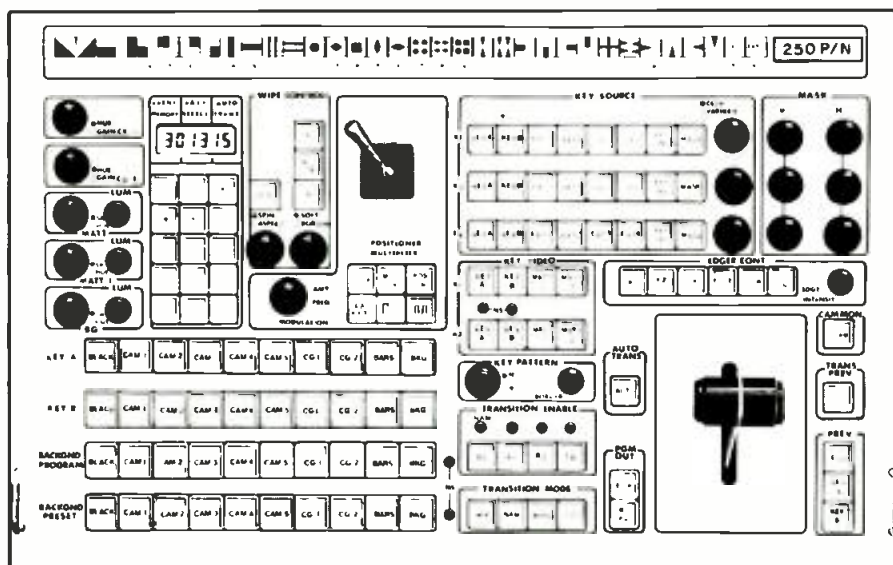

Switching! Preview! Automation!

Get it all together in the new super-compact 250 P/N systems. A totally self-contained system (PAL/NTSC) with production power totally unique for a switcher this size (12 1/4" H X 19" W X 6" D). Also includes 10 inputs, 5 video levels, 5 keying levels, 4 transistor modes and much, much more. For all advanced features of the 250/PN, contact your nearest Vital office.

The 3-in-one System from VITAL for big time production

Get it all together or one at a time!

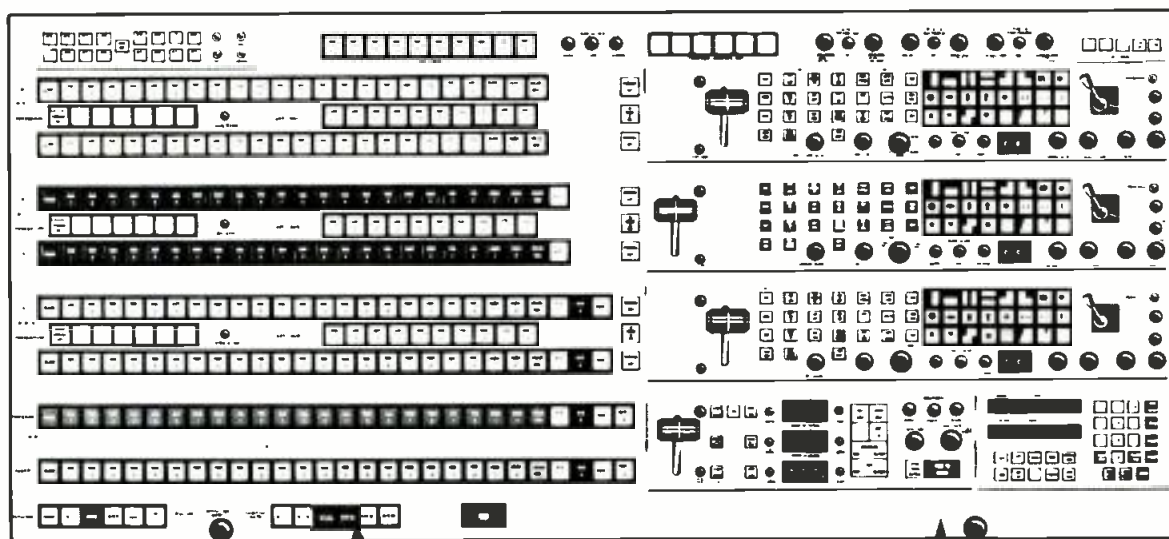

VIX-114 SERIES
Video Switchers

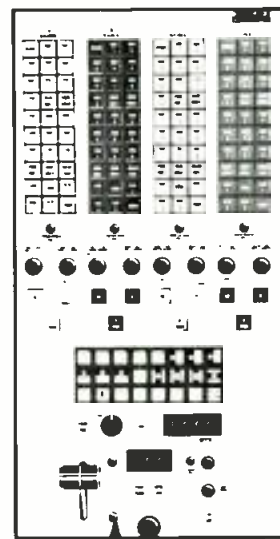

PSAS-2
Production Switching
Automation Systems

SQUEEZOOM®
Optical Effects
Synchronizer

Features fully described in our brochure.

HI TECHNOLOGY PRODUCT INNOVATORS



VITAL INDUSTRIES, INC.

MAIN OFFICE: 3700 NE 53rd Ave.
Gainesville, FL 32601 USA

PHONE: 904/378-1581
TWX: 810-825-2370
TLX: 80-8572-Vital-A-Gain

ERIC KING (Southeast) (804) 384-7001 • MORRELL BEAVERS (Midwest) (812) 466-3212 • ROBERT McALL (Northeast) (518) 966-5180
• BARRY ENDERS (Northeast) (315) 589-9289 • WEST COAST (Hollywood) (213) 463-7393 • GORDON PETERS (Southcentral) (817) 467-0051 • MIKE BARSNESS (Northcentral) (612) 447-4453 • JIM MONEYHUN (Northwest) (415) 561-9130

Circle 232 on Reader Service Card

Reps/Dists

Minnesota continued

KODO ASSOC

9031 Penn Ave S
Minneapolis 55431
612 881-1255
Line: video equip
Knox see ad pg 98

KENNETH MEYERS CO

3601 Park Central Blvd
Minneapolis 55416
612 920-7080
Line: audio & test equip
Marconi see ad pg 120

PAUL OHLIN

6004 Olinger Blvd
Mpls 55436
612 929-6924
Line: broadcasting equip
Alexander see ad pg 112

RESOURCE MKTG

2636 Humboldt Ave
Minneapolis 55408
612 374-2832
Line: audio equip
dbx see ad pg 99

SOUND 80, INC

2709 E 25 St
Minneapolis 55406
612 721-6341
Line: audio components, equip
ADR see ad pg 130

TODD COMMUNICATIONS INC

7360 Ohms Ln
Minneapolis 55435
612 835-3080
Line: video equip
Arvin/Echo see ad pg 139
Ikegami see ad pgs 15, 143
ISI see ad pg 83

DALE TUCKER

8398 139th Ct
Apple Valley 55124
612 432-7010
Line: broadcast equip
Cetec see ad pg 76

MISSISSIPPI

BCA

PO Box 2606
Peachtree City GA 30269
404 487-9559
Line: audio RF & test equip
Elcom see ad pg 152

GEORGE BIRX

Stones Mountain GA
404 891-5465
Line: video equip
Anvil Cases see ad pg 84

CENTRAL SCHOOL SUPPLY

217 W Capital St
Jackson 39205
601 969-6700
Line: audio & video equip
Clear/Com see ad pg 146

GRAY COMMUNICATIONS

5441 Pepsy St.
New Orleans LA
504 733-7265
Line: video equip
Arvin/Echo see ad pg 139

RALPH HUCABY

1331 Otter Creek Rd
Nashville TN 37215
615 373-0231
Line: video equip
Asaca see ad pg 59

SISK ENGINEERING

PO Box 587
Fulton 38843
601 842-3626
Line: audio equip
Inovonics see ad pg 124

MISSOURI

CENTURIAN MARKETING ASSOC

Box 1011
124 Manchester Rd
Blodwin 63011
314 227-7229
101 E Gregory Blvd
Kansas City 64114
816 333-0303
Line: audio equip
dbx see ad pg 99
Otari see ad pg 63
Eumig see ad pg 185

COMMUNICATIONS SYSTEMS

Drawer C
Cape Girardeau 63701
314 334-6097
Line: audio components
Elcom see ad pg 152
Inovonics see ad pg 124

COMMUNITRONICS CORP

1907 S Kings Hwy
St. Louis 63110
314 771-7160
Line: video equip
Viscount see ad pg 152

DOUG CURRY

PO Box 1108
Burnsville MN
612 894-3047
Line: video equip
Anvil Cases see ad pg 84

DELCOM CORP

2349 Grissom
St Louis 63141
314 431-1164
Line: video equip
ISI see ad pg 83

ENGINEERING SERVICES CO

8420 Delmar Blvd
St Louis 63124
314 997-1515
Line: video equip
Allen Avionics see ad pg 145

GORDAN FIXMAN ENG CO

8160 Stanford Ave
St Louis 63130
314 752-5219
Line: broadcast components
Lightning Elimination see ad pg 100

LEEMARK ENGINEERS

7234 Wornall Rd
Kansas City 64114
913 648-0124
Line: broadcast components
Lightning Elimination see ad pg 100

PAC

11920 Grandview Rd
Grandview 64030
816 763-4155
338 Brooks Dr Suite F
Hazelwood 63042
314 731-2331
Line: full line broadcast & test equip
Marconi see ad pg 120

TELEVISION ENGINEERING CORP

519 Rudder Rd
Fenton 63026
314 343-5605
Line: broadcast equip
Conrac see ad pg 136
Ikegami see ad pgs 15, 143

VIDEO MASTERS INC

1820 Wyanfotte St
Kansas City 64108
816 474-8530
Line: video equip
Arvin/Echo see ad pg 139

OPTICAL EFFECTS

THROUGH MICROPROCESSOR-
CONTROLLED SLIDE DISSOLVE



MODEL 4220
DISSOLVE PROJECTOR

- ★ STATIONARY OPTICS
- ★ ADJUSTABLE DISSOLVE RATE
- ★ SUPERIMPOSITION
- ★ EXTRA LARGE CAPACITY
- ★ AUDIO PROGRAMMABLE

FROM THE WORLD'S LARGEST SUPPLIER
OF TELECINE EQUIPMENT

LAIRD TELEMEDIA INC.
2424 SOUTH 2570W • 801 974-5900
SALT LAKE CITY, UTAH 84115

Circle 233 on Reader Service Card

Unsurpassed Reliability

The new MCI JH-110B Series Tape Recorders/Reproducers



Transformerless Electronics
Universal Application
Special models for studio,
broadcast, film, video and
disc mastering use.
Mono to 8 Track
versions available
Featuring New
RTZ III

JH-110B Tape Recorder/Reproducer

MCI 1400 W. Commercial Blvd., Ft. Lauderdale, FL 33309
Phone: (305) 491-0825/Telex:514362 MCI FTL

Circle 234 on Reader Service Card



**ELECTRONIC INTERLOCK
MAGNETIC FILM
RECORDERS and REPRODUCERS
THE STANDARD OF HOLLYWOOD
AND THE WORLD**

FOR FILM AND TELEVISION RE-RECORDING
ELECTRONIC LOOPING
HIGH SPEED DUBBING
TELECINE MAGNETIC FOLLOWERS
HIGH SPEED PROJECTORS
VIDEO TAPE-FILM INTERLOCK SYSTEMS
TOTAL FACILITY ENGINEERING

Sydney
Magna-Techtronics (Aust.) Pty., Ltd.
P.O. Box 150
Crows Nest NSW 2064, Australia
Telex 24655

London
Branch & Appleby
42 High Street
Harrow-on-the-Hill
Middlesex HA1 3LL,
England

MAGNA-TECH ELECTRONIC CO., INC.

630 Ninth Avenue, New York, N. Y. 10036

Telephone (212) 586-7240

Telex 126191

Cables "Magtech"

Circle 235 on Reader Service Card

Reps/Dists

MONTANA

PAC

11920 Grandview Rd
Grandview 64030
816 763-4155
3829 Old Hwy 9450
St Charles
314 441-6600
Line: test & measurement
Marconi see ad pg 120

JIM SMITH

PO Box 146
Jackson 63755
314 243-1006
Line: audio equip
Cetec see ad pg 76

NEBRASKA

CENTURIAN MKTG

Box 1011 124 Manchester Rd
Blaawin MO 63011
314 227-7229
Line: full line of audio equip
Otari see ad pg 63

DOUG CURRY

PO Box 1108
Burnsville MN
612 894-3047
Line: broadcast components
Anvil Cases see ad pg 84

McMARTIN INDUSTRIES

4500 S 76 St
Omaha 68127
402 331-2000
Line: professional radio equip.
Inovonics see ad pg 124
UMC see ad pg 150

TODD COMMUNICATIONS INC

120 S 41st St
Omaha 68131
402 551-7600
Line: full line video equip
Ikegami see ad pgs 15, 143

NEVADA

LP MKTG

2036 Livingston St Ste 5
Oakland CA 94606
415 532-5606
Line: full line of audio equip
Otari see ad pg 63

NEW HAMPSHIRE

GMI

181 Worchester Rd Rte 9
Natick MA 01760
617 237-6544
Line: full line of audio equip
Otari see ad pg 63

PROFESSIONAL VIDEO SYSTEMS

1616 Soldiers Field Rd
Boston MA 02135
617 254-2101
Line: video equip
Arvin/Echo see ad pg 139

VERN RUSSELL

5 Flint Meadow Rd
Brookline 03033
603 673-5700
Line: broadcast equip
Harris see ad pgs 12, 32, 127

STEVE THACHER

Fishkill NY
914 896-5860
Line: video equip
Anvil Cases see ad pg 84

NEW JERSEY

AF ASSOC

100 Stonehurst Ct
Northvale 07647
201 767-1000
Line: audio & video equip

ALEXANDER BATTERY

NE 47 Lenape Dr
Montville 07045
Line: broadcasting equip
Alexander see ad pg 112

JB ANTHONY CO

992 High Ridge Rd
Stamford CT 06905
203 322-9202
Line: full line of audio equip
Otari see ad pg 63

ASSOCIATED SALES REPS

403 Fieldstone Ct
Fallstone MD 21047
Line: full line of audio equip
Otari see ad pg 63

AUDIO INTERNATIONAL

424 Grant Ave
Scotch Plains 07076
201 322-4466
Line: audio equip
Inovonics see ad pg 124

CINECRAFT INTL INC

11 Ceasar Pl
Moonachie 07074
201 939-0875
Line: lighting equip
Frezzolini see ad pg 132

COMMERCIAL VIDEO REPRESENTATIVES

12921 Dover Rd
Reisterstown MD 21136
301 879-1794
Line: video equip
Arvin/Echo see ad pg 139

FR DICKINSON JR INC

9 Westinghouse Plaza
Bloomfield 07003
201 429-8996
Line: audio equip
Inovonics see ad pg 124

EASTERN METRO ASSOCIATES

2 Francis Rd
E Brunswick 08816
201 254-2555
Line: video equip
Allen Avionics see ad pg 145

SYLVAN GINSBURY

660 Kinderkamack Rd
Oradell NJ 07649
201 261-3200
Line: RF equipment
Electro Impulse see ad pg 177

H M HOLZBERG ASSOCS

PO Box 322
Totowa 07511
201 256-0455
Line: full line audio, video, microwave equip.
Inovonics see ad pg 124
Elcom see ad pg 152
Clear/Com see ad pg 146
NEC see ad pg 81
TFT see ad pg 151
Utah Scientific see ad pg 102

BROADCAST QUALITY WEATHER RECEIVER

Mod. CRW; 162.40, 162.475, 162.55 mhz.



Take advantage of the expanding network of National Weather Service VHF weather stations. This sensitive, selective (and reasonably priced) receiver can bring you accurate local weather, national weather, weather radar data, emergency alert messages, plus farming and marine information where applicable. Its capability for unattended recording of emergency alert messages and updated forecasts can save time and money. Rebroadcast is FCC authorized.

Receiver is rack mountable, remoteable, with an attractive black anodized panel. Demuting and remote alarm are initiated by 1050 "Alert" tone. A relay closure is initiated by either the 1050 tone or a 1650 hz. forecast update signal tone. These are the only tone signals NWS uses.

Crystal and ceramic IF Filters, plus double tuned dual gate MOSFET RF stage, give excellent interference rejection and high sensitivity (.28 microvolts for 12 db. (S+N)/N.). Whip antenna, jack and terminals for external antennas. One year Warranty.

GORMAN-REDLICH • 6 Curtis St. • Athens, OH • 45701
Phone (614) 593-3150
Circle 236 on Reader Service Card

QUICK CONNECTIONS

Specify Lemo when ease of connection and disconnection is essential. To engage and lock, push straight in. To unlock and disengage, pull straight out. Simple!

Superb design and workmanship, ruggedness, miniature size and high density mounting,

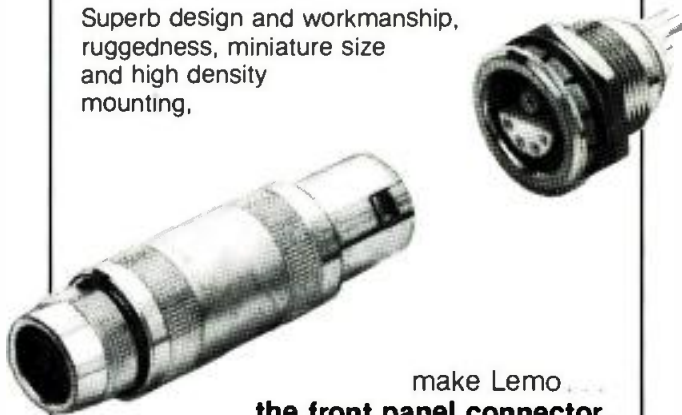

make Lemo...
the front panel connector.

LEMO USA INC

P.O. BOX 6626, SANTA ROSA, CA 95406 • 707/523-0600

Circle 237 on Reader Service Card

Reps/ Dists

New Jersey continued

JOEL & ASSOC

528 River Rd
Teaneck 07666
201 836-8741
Line: audio equip
ADR see ad pg 130
Inovonics see ad pg 124

LANDY ASSOCS

12 Buxon Rd
Cherry Hill 07003
609 424-4660
1890 E Marlton Pike
Cherry Hill 08003
Line: audio & video equip
Asaca see ad pg 59
Datek see ad pg 179
Ikegami see ad pgs 15, 143
Skotel see ad pg 108

L&M ASSOCS

511 Victor St
Saddle Brook 07662
201 843-8700
Line: test instruments
Marconi see ad pg 120

METRORED SALES INC

76 W Main St
Freehold 07728
201 462-1221
Line: video equip
Skotel see ad pg 108

MTI CORP

124 Montclair Ave
Montclair 07042
201 744-2220
Line: audio equip
Inovonics see ad pg 124

NORTHREP

380 Ratzer Rd
Wayne 07470
201 694-7976
Line: audio equip
Eumig see ad pg 185

SHEA SALES

552 Prospect St
Maplewood 07070
201 762-2382
Line: audio equip
Ramko see ad pgs 28-29, 154-155

TELE-MEASUREMENTS INC

145 Main Ave
Clifton 07014
201 473-8822
Line: video equip
Conrac see ad pg 136
ISI see ad pg 83

STEVE THACHER

Fishkill NY
914 896-5860
Line: video equip
Anvil Cases see ad pg 84

HARRY J WHITE CO

PO Box 166
Cherry Hill 08002
609 428-4544
Line: video equip
Allen Avionics see ad pg 145

NEW MEXICO

MARVIN BREDEMEIER

1253 2 Iroquois NE
Albuquerque 87112
505 293-4707
Line: broadcast equip
Harris see ad pgs 12, 32, 127

DYMA ENGINEERING

PO Box 1697
Taos 87571
505 758-2686
Line: full line radio & TV equip
BTX see ad pg 176
Elcom see ad pg 152
ESE see ad pg 183
ISI see ad pg 83
LPB see ad pg 170

MAGNETIC MEDIA

222 Truman NE
Albuquerque 87108
505 265-8355
1213 N Lea
Roswell 88201
505 622-6393
Line: video equip
ISI see pg 83
Knox see ad pg 98

RA MAYES CO

11910 Central SE
Albuquerque 87123
509 292-2330
Line: broadcast components
Lightning Elimination see ad pg 100

MEASUREMENT CONSULTANTS INC

PO Box 951
Las Cruces 88001
505 526-2491
PO Box 8362
Albuquerque 87108
505 265-6471
Line: test equip
Marconi see ad pg 120

NEW YORK

BERT AARON ASSOC

55 Northern Blvd
Garden City 11548
516 627-0630
Line: RF equip
Electro Impulse see ad pg 177

JB ANTHONY CO

992 High Ridge Rd
Stamford CT 06905
203 322-9202
Line: audio equip
Otari see ad pg 63

DAVID BAIN ASSOC

PO Box 1014
11 Orchard Farm Rd
Port Washington 11050
516 883-4818
Line: audio equip, video equip
ESE see ad pg 183
Inovonics see ad pg 124
ISI see ad pg 83
Ikegami see ad pgs 15, 143

BOYNTON STUDIO INC

Melody Pines Farm
Morris 13808
607 263-5695
Line: audio & recording equip
Inovonics see ad pg 124

THE CAMERA MART

456 W 55 St
New York 10019
212 757-6977
Line: full line TV production equip
Anton/Bauer see ad pg 93
Arvin/Echo see ad pg 139
Clear/Com see ad pg 146
Frezzolini see ad pg 132
Ikegami see ad pgs 15, 143

CANTER REDMAN TECHNOLOGIES

321 W 49 St
New York 10036
212 245-5505
Line: video equip
Viscount see ad pg 152



soft SMPTE for the '80s

BTX software based Series 50 offers every SMPTE time code function including: generate, read, digital display, in-video display, jam sync, user bits and optional vertical interval format.

These functions are available individually or in any combination. Series 50 delivers the superb performance, quality and reliability you have come to expect from BTX.

The BTX Corporation | 12 Huron Drive, Natick, Massachusetts 01760, (617) 891-1230
6255 Sunset Boulevard, Hollywood, California 90028, (213) 462-1506



Circle 238 on Reader Service Card

Reps/Dists

New York continued

DIVERSIFIED LIGHTING SYSTEMS
116 Town Line Rd
PO Box 57
Syracuse 13211
315 455-5811

EASTERN METRO ASSOCIATES
3 Eva Ln
Plainview 11803
516 931-1414
Line: video equip
Allen Avionics see ad pg 145

JOHN FREDERICK
New York
212 575-2124
Line: video equip
3M Video see ad pgs 56, 117

ROBERT HALLENBECK
11 Ridgecrest
Lathan 12110
518 785-9144
Line: broadcast equip
Harris see ad pgs 12, 32, 127

HARVEY RADIO
23 West 45th St
New York 10036
212 723-5211
Line: broadcasting equip
Clear/Com see ad pg 146

HM HOLZBERG ASSOC
PO Box 322
Totowa NJ 07511
201 256-0455
Line: audio, RF, test equip
Elcom see ad pg 152

FRANK IACONIS
PO Box 338
Auburn 13021
315 252-4177
Line: audio equip
Otari see ad pg 63

L & M
175 W 12th St
New York 10011
212 243-6155
Line: test equip
Marconi see ad pg 120

MARTIN AUDIO/VIDEO CORP
423 W 55th
New York 10019
212 541-5900
Line: audio components, equip,
recording accessories
ESE see ad pg 183
Clear/Com see ad pg 146
Inovonics see ad pg 124

MPCS VIDEO INDUST.
514 W 57th St
New York 10019
212 586-3690
Line: broadcast equip
Ikegami see ad pgs 15, 143
ISI see ad pg 83
Clear/Com see ad pg 146

NET SALES INC
1245 Marsh Rd
Pittsford 14534
716 467-4538
Line: audio components

NORTHEAST BROADCAST LABS
PO Box 1176
South Glen Falls 12801
518 793-2181
Line: audio RF equip
LPB see ad pg 170
UMC see ad pg 150

NORTHREP
PO Box 151
Wilmington 12997
518 946-7205
Line: audio equip
Eumrig see ad pg 185

BILL PEGLER
New York
914 763-8893
Line: video components
TEA see ad pgs 148, 186, 199

RON PHENICIE
Danville PA
717 275-7900
Line: video equip
Anvil Cases see ad pg 84

PINZ SALES
570 Yonkers Ave
Yonkers 10704
Line: audio equip
Modular Audio see ad pg 90

PUELO ELECTRONICS
39 Hutcheson Pl
Lynbrook 11563
516 599-4875
Line: broadcast components
Lightning Elimination see ad pg 100

JACK SCHAFFER
16-44 202 St
Bayside 11360
212 352-8838
Line: video equip
Knox see ad pg 98

SINGER PRODUCTS CO
One World Trade Center
Suite 2365
New York 10048
212 432-1400
Line: audio components
Clear/Com see ad pg 146

SONOCRAFT CORP
360 W 31 St
New York 10001
29 W 36 St
New York 10018
212 760-9300
Line: audio & video equip
Conrac see ad pg 136
Gray Engineering see ad pg 180

TAEREP INC
Box 597
Binghamton 13902
607 722-9265
Line: television equip
Marconi see ad pg 120

TELESCO INT'L SALES CO
#1 Dupont St S
Plainview 11803
516 433-6210
Line: audio components, video equip,
test equip
Ramko see ad pgs 28-29, 154-155

STEVE THACHER
Fishkill NY
914 896-5860
Line: video equip
Anvil Cases see ad pg 84

TESCO ASSOC
2002 Teall Ave
Syracuse 13206
315 463-4566
Line: broadcasting equip
Alexander see ad pg 112

TRI-CHROMA
100 North Rd
White Plains 10603
914 761-8293
Line: audio equip
Knox see ad pg 98

ELECTRO IMPULSE

Thanks You for Making Our
Model DPTC-25KFM Dummy Load
One of our Most Successful Products!



**MODEL
DPTC-25KFM**
Rated 25KW
DC-110MHz
VSWR 1.15:1
Useable to 200MHz

Load is Dry,
Forced Air Cooled,
Fully Interlocked and
**WARRANTED
FOR 25 MONTHS**

Our New General Catalog 891 is now
available upon request covering:

- Dummy Loads • Baluns • Calorimeters
- Power Meters/Attenuators

EXCELLENCE IN ENGINEERING
**Electro
IMPULSE, INC.**

SINCE 1949

116 Chestnut St., Red Bank, N.J. 07701
Telephone: 201-741-0404

Circle 239 on Reader Service Card

Go anywhere super-rugged SMPTE/EBU Edit Code Generators and Companion Reader that will give you an instant shot list.



The only portable SMPTE/EBU Edit Code Generators.

- Goes anywhere with your ENG crew. 2.0mA max. battery drain.
- Very light and rugged. It attaches to your VTR and produces accurate edit code as you shoot an important scene. More than 500 units in use worldwide.
- Model 640 for SMPTE, Model 641 for both SMPTE/EBU with LCD constant display and user code capability.



Model 644 Edit Code Reader plus off-line editing printer.

When Shintron builds a new product, we think of our customers' convenience first. Good Edit Code Readers are a dime a dozen today, but which one can generate an instant shot list? The only one is Model 644 Edit Code Reader/Raster Display and Shot List printer.

SHINTRON Worldwide

Cambridge, MA 02142 USA
Telephone (617) 491-8700 Telex 921497

Circle 240 on Reader Service Card

Reps/ Dists

New York continued

UPSTATE MARKETING & SALES
PO Box 338
Auburn 13021
315 252-4177
Line: audio equip
Otari see ad pg 63

VIDEO COMPONENTS INC
601 S Main St
Spring Valley 10977
914 356-3700
Line: full line video equip
Anton/Bauer see ad pg 93
Video Aids see ad pg 197

JG WELCH ASSOCIATES
98 Fairview Crs
Rochester 14617
716 244-1100
2224 Maynard Ave
Utica 13502
315 736-7821
Line: video equip
Allen Avionics see ad pg 145

NORTH CAROLINA

GEORGE BIRX
Stones Mountain GA
404 891-5465
Line: video equip
Anvil Cases see ad pg 84

DOUG COOK & ASSOC
PO Box 7244
Charlotte 28217
614 447-4114
Line: audio equip
Ramko see ad pg 28-29, 154-155

ELECTRONICS MERCHANDISING ENTERPRISE
112 Buena Vista
High Point 27260
919 869-3335
Line: SCA & test equip
NEC see ad pg 81
TFT see ad pg 151

EME
112 Buena Vista High Point 27260
919 869-3335
Line: video equip
Knox see ad pg 98
NEC see ad pg 81
TFT see ad pg 151

FM ASSOCIATES
PO Box 156
106 Elam Ave
Ramscur 27316
919 824-2196 or 824-8461
Line: broadcast components
Lightning Elimination see ad pg 100

GRAY COMMUNICATIONS
1709 Stuart Ave
Albany GA 31755
912 435-8386
Arvin/Echo see ad pg 139

NORTH DAKOTA

DOUG CURRY
PO Box 1108
Burnsville MN
612 894-3047
Line: video equip
Anvil Cases see ad pg 84

ENTERPRISES INC
6001 N 91 St
Milwaukee WI 53225
414 358-1007
Line: audio, RF, test equip
Elcom see ad pg 152

TODD COMMUNICATIONS
PO Box 1063
Grand Forks 58201
701 746-1268
Line: video equip
7360 Ohms Ln
Minneapolis MN 55435
612 835-3080
Arvin/Echo see ad pg 139
Ikegami see ad pgs 15, 143

OHIO

ASHBY ASSOCIATES
4130 Linden Ave
Dayton 45432
513 252-5627
Line: video equip
Allen Avionics see ad pg 145

AUDIO MARKETING ASSOCIATES
9470 Whitewood Rd
Brecksville 44141
216 526-2426
Line: audio equip
Eumig see ad pg 185

AUDIO DISTRIBUTORS INC
2342 S Division Ave
Grand Rapids MI 49507
616 452-1596
Line: audio, RF & test equip
Elcom see ad pg 152

AUDIO SOURCE MKTG
Great Northern Blvd
4986 Gateway Dr
Medina 44256
216 725-8871
Line: audio equip
dbx see ad pg 99

A/V MEDIA INC
6601 Huntley Rd
Columbus 43229
614 272-0014
Line: full line video/audio products
ISI see ad pg 83

WALTER J BRAUER & ASSOC
PO Box 305
30432 Euclid Ave Rm 210
Wickliffe 44092
216 943-0601
PO Box 35
Vandalia 45377
Line: broadcast components
Lightning Elimination see ad pg 100

DOUG COOK & ASSOC
7750 Lucerne #05
Cleveland 44130
216 826-4508
Line: full line broadcast equip
Bdcst Controls see ad pg 148
Ramko see ad pgs 28-29, 154-155
TFT see ad pg 151

HM DYER ELECTRONICS
31185 Ten Mile Rd
Framington Hills MI 48024
313 478-2157
Line: video equip
Asaca see ad pg 59

EQS SYSTEMS
8517 Herrick Dr
Chesterland 44026
216 729-2222
Line: test & measuring equip
Marconi see ad pg 120

KLOPF A/V CO
3381 Successful Way
Dayton 45414
513 236-5500
7425 Royalton Rd
N Royalton 44133
216 237-1950

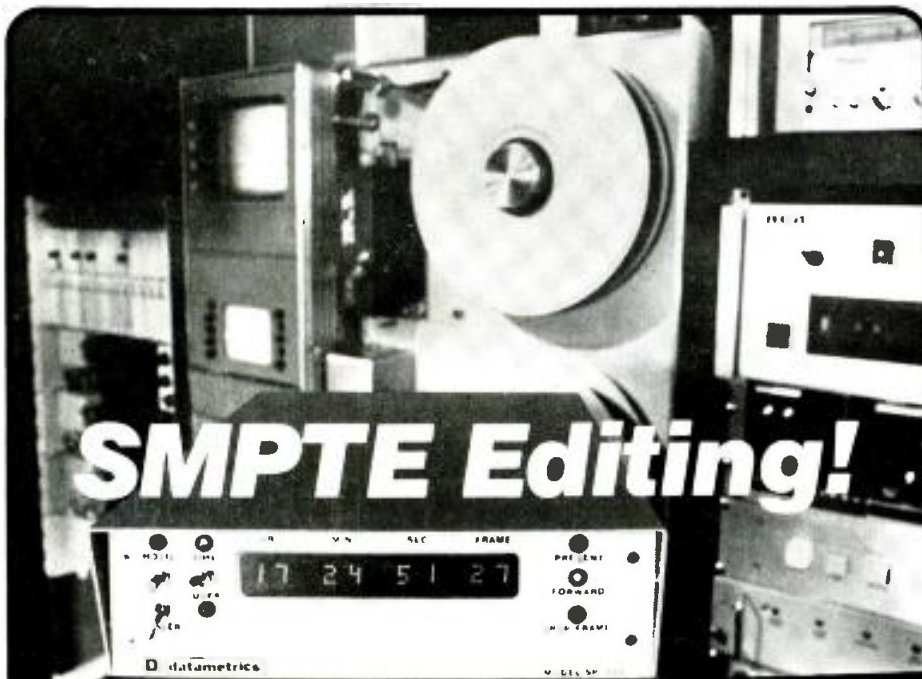

- Datametrics Compact SP733 Reads Time/User Information Over All Input Ranges.
- Manual Use Based on Display and/or Video Inserter.
- Automatic Use Based on Logic Compatible Outputs.



datametrics

Datametrics, Inc.
340 Fordham Road, Wilmington, Mass 01887
Tel: (617) 658-5410 TWX 710-347-7672

Circle 241 on Reader Service Card

TOWER POWER ...

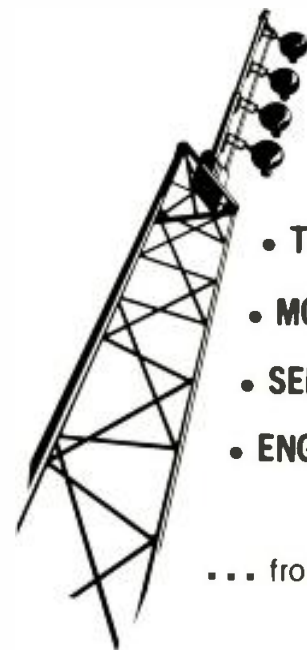

- TOWERS
- MONOPOLES
- SERVICE
- ENGINEERING

... from



FRED A. NUDD CORPORATION
1743 Route 104
Ontario, New York 14519
(315)524-2531

Circle 242 on Reader Service Card



The Investment that grows

DATATEK D-2000 ROUTING SWITCHERS

Industry leading technical performance.

For example, maximum audio output is +30dBm without requiring transformers and noise is over 105dB below maximum output.

Inherent reliability.

For example, the D-2000 **avoids** putting multiple inputs and outputs on a common PC board, **avoids** party lining control systems in preference to private lining and **avoids** reliance on a central microprocessor system. Instead, each input and each output bus are on individual plug-in modules and each output bus has its own independent microprocessor control system. A fault therefore can only affect one input or one output and not the entire system.

Expansion Capacity to 250x250 Systems, with up to 8 control levels. There is no need to specify initially the ultimate matrix size.

Large Selection of Control Panels.

For example, there are over 25 different standard control panels, including individual pushbutton, keypad, alpha numeric and CRT matrix status display. Datatek can also design control panels for special requirements. Control is over a single coax line.

For More Information, Write or Call:



1166 W. CHESTNUT ST.
UNION, NJ 07083 • 201-964-3656

Circle 243 on Reader Service Card

SMPTE EDIT-CODE

READER AND CHARACTER-GENERATOR



THE NEW STANDARD OF THE INDUSTRY

FEATURES: The McFadin Window™ wide range digital decoder, highly legible and unique FONT, 1-3/4" rack mounting, vertical interval display, all front panel controls, drop frame indicator, choice of Time-Code or User-Bits, regenerated Time-Code output (DUB). MODEL DR-107A



GRAY ENGINEERING LABORATORIES

504 W. Chapman Ave.
Orange, Ca. 92663 714-997-4151

Circle 244 on Reader Service Card

A New World Standard

MCI's JH-600 Series Recording/Remixing Consoles

The First Factory Automated Console

Affordable Priced

Many options available

For: recording studios, broadcast production, live shows, mobile facilities



JH-636-36VU Recording/Remixing Console

MCI® 1400 W. Commercial Blvd., Ft. Lauderdale, FL 33309
Phone: (305) 491-0825/Telex:514362 MCI FTL

Circle 245 on Reader Service Card

Reps/Dists

Ohio continued

2121 Riverside Dr
Columbus 43221
614 488-5885
4131 Westward Ave
Columbus 43228
614 488-5885
Line: full line A/V equip
Conrac see ad pg 136
Arvin/Echo see ad pg 139
ESE see ad pg 183
ISI see ad pg 83
Clear/Com see ad pg 146

JAMES MARWOOD
718 Old Coach Rd
Westerville 43081
614 882-8506
Line: broadcast equip
Harris see ad pg 12, 32, 127

McFADDEN SALES INC
4645 Executive Dr
Columbus 43220
614 459-1280
Line: audio components, equip

MIDWEST CORP
1150 C W 8th St
Cincinnati 45203
513 651-1904
Line: broadcast equip
Ikegami see ad pgs 15, 143

MIDWEST TELE COMMUNICATIONS
1150 C W 8 St
Cincinnati 45203
513 651-1904
1021 W 8 St
Cincinnati 45203
513 651-1904
Line: full line video equip
Anton/Bauer see ad pg 93
Ikegami see ad pgs 15, 143
ISI see ad pg 83
Clear/Com see ad pg 146

OHIO INSTRUMENTS
7180 Brundage Road
Waldo 43356
614 726-2828
Line: test instruments
Marconi see ad pg 120

JB PARENT CO
Great Northern Bldg
4986 Gateway Dr
Medina 44256
216 725-8871
Line: audio equip
Otari see ad pg 63

RICK PARENT
Columbus
614 890-8623
Line: video equip
Anvil Cases see ad pg 84

TOM STEELE
3824 Green Rd
Perry Village 48081
216 259-3107
Line: audio equip
Otari see ad pg 63

OKLAHOMA

DELCOM CORP
6019 S 66 E Ave
Tulsa 74145
918 494-9500
Line: video & lighting equip
Conrac see ad pg 136
ISI see ad pg 83

HILL RADIO EQUIPMENT
PO Box 622
Claremore 74017
918 341-5240
Line: broadcast equip
Elcom see ad pg 152

CURTIS LUTZ
1021 N Hickory Pl
Broken Arrow 74012
918 251-8808
Line: broadcast equip
Harris see ad pgs 12, 32, 127

MARTIN ZIENKOSKY BROWNE & ASSOC
3035 E Skelley Dr Ste 240
Tulsa 74105
918 743-6673
Line: RF, monitoring equip
TFT see ad pg 151

MZB & ASSOC
3035 E Skelly Dr Ste 240
Tulsa 74105
918 743-6673
Line: audio equip
Ramko see ad pgs 28-29, 154-155
TFT see ad pg 151

GENE SUDDUTH CO
845 39 St SE
Paris TX 75460
214 785-5764
Line: video equip
Asaca see ad pg 59

TABCON
PO Box 26
Bixby 74008
918 369-2559
Line: broadcast equip
Inovonics see ad pg 124

TENICKE
6432 Westchester
Houston TX 77005
713 663-6432
Line: audio equip
Otari see ad pg 63

OREGON

COLUMBIA TELECOMMUNICATIONS
2241 W Burnside
Portland 97210
503 223-4546
Line: full line audio & video equip
Viscount see ad pg 152

RAY JOHNSTON
15014 NE Rose Pkwy
Portland 97230
Line: audio equip
Eumig see ad pg 185

COMPONENTS WEST
13540 NW Mill Creek Dr
Portland 97229
503 643-5588
Line: video equip
Allen Avionics see ad pg 145

CUSTOM VIDEO
1752 15 Ave NE
Seattle WA 98115
206 524-1026
Line: video & lighting equip
Arvin/Echo see ad pg 139

NORTH SHORE MKTG
15084 NW 65 St
Redmond WA 98052
206 455-5846
Line: audio equip
Otari see ad pg 63

VIDEOSONICS INC
821 SE 14 Ave
Portland 97214
503 232-4632
Line: video/audio, lighting equip
ISI see ad pg 83
Clear/Com see ad pg 146

JIM ZACHE
18860 NW Rock Creek
Portland 97229
503 648-9873
Line: video equipment
Cetec see ad pg 76

FUJINON

ENG/EFP and BCTV lenses...to improve your image.



3.5x6.5
wide angle zoom



F/1.4
Ultra-wide 6mm



F/1.6 10x11
lightweight zoom

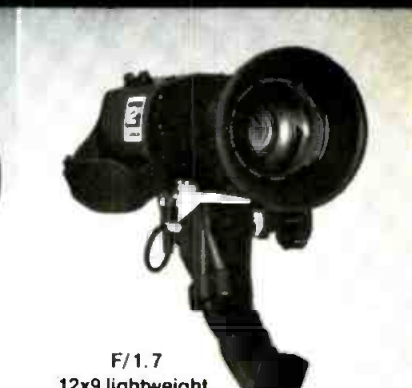

F/1.7
12x9 lightweight
zoom with 2X extender



F/1.7 14x9.5 lightweight zoom
with 2X extender



F/1.7 14x9.5 lightweight zoom
with diascopes
and 2X extender



F/1.7 17x9 zoom
with built-in
2X extender



F/2 22x12.5 zoom
with built-in
2X extender

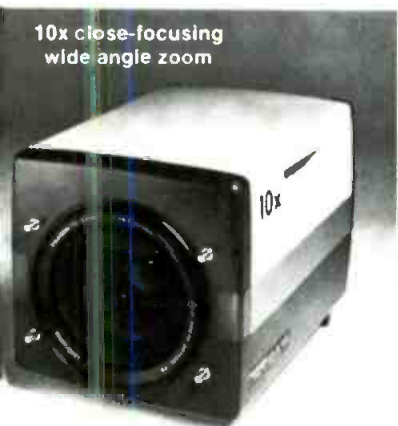

10x close-focusing
wide angle zoom



16X lightweight
4-range wide angle zoom



30X twin range
field zoom



14X ultra high resolution zoom,
constant F/2.1 and built-in test
pattern projector and 2X extender

Here's the FUJINON line. With more ENG/EFP lenses than anyone else. All available with studio conversion kits for extra economy. All with adjustable back focus for faster lens changing.

If you want to get in close, consider the new 22X zoom with built-in 2X extender. It gives you F/2 speed with a total range of 12.5 to 550 mm. If you're ready in close, use the unique F/1.4 6 mm ultra wide angle distortion-free lens. It

gives you a "0" MOD with a 70° horizontal field of view.

For studio and field productions, FUJINON BCTV lenses are now offered with built-in test pattern projectors for the fastest, most accurate computerized camera set up. (Not available on 10X wide angle zoom.)

For maximum definition, the new 14X ultra high resolution lens reads 1300 TV lines and maintains a fast F/2.1 in all zoom and focus ranges.

Quality, performance and service make FUJINON best. Camera manufacturers, networks, stations and production companies around the world have made FUJINON first. Before you buy any camera from any manufacturer or replace any lenses on your existing cameras, see the difference for yourself. Specify FUJINON. It will improve your image.



Fujinon Optical Inc. 
672 White Plains Road
Scarsdale, New York 10583
(914)472-9800

West Coast Distributor
FUJI OPTICAL SYSTEMS INC.
4855 Atherton Avenue
San Jose, California 95130
(408) 866-5466

Circle 246 on Reader Service Card

THE NEWS— THE NEW **Schneider** KREUZNACH



ENG/EFP
LENSES
for all cameras
with $\frac{2}{3}$ "
pick-up tubes



Jos. Schneider GmbH & Co., Optische Werke
P. O. Box 947, D-6550 Bad Kreuznach
Fed. Rep. of Germany
☎ (0671) 60 11, Telex 042 800

Exclusive Agent USA and Canada:
Tele Cine Inc., 5434 Merrick Road, Massapequa, N.Y. 11758
☎ (516) 798-2828, TWX 5 102 246 138

10x Standard 1.8/10-100

The most compact lens there is with a complete range of accessories for all applications.

15x Wide Angle 1.7/8.5-125 with x2 Range Extender

The widest horizontal angle of view 53° without attachments, focal lengths to 250 mm with x2 flip-in range extender.

20x Standard 1.4/12-240

The ideal lens for EFP work. Suitable for studio and field productions.

30x Wide Angle 1.4/8.7-260

30x Standard 1.4/11-330

30x Tele 1.4/18.5-550

The latest developments of the internationally known 30:1 lenses. Designed to increase EFP camera capabilities. All Lenses have complete range of operational accessories.

Other lenses for studio and O.B. cameras:

TV-Lenses for cameras
with $1\frac{1}{4}$ " pick-up tubes

11x Studio	2.1/18-200
15x Wide Angle	2.1/16-240
30x Wide Angle	2.1/16-480
30x Standard	2.1/20-600
30x Tele/OB	2.1/33-1000

TV-Lenses for cameras
with 1" pick-up tubes

10x Studio	2.1/17-170
20x Standard	2.1/17-340
11x Studio	1.7/14-150
15x Wide Angle	1.7/12.5-190
30x Wide Angle	1.7/12.5-375
30x Standard	1.7/16-480
30x Tele/OB	1.7/26-800

Reps/Dists

PENNSYLVANIA

ALPHA VIDEO & ELECTRONICS CO

9 E Mall Plaza
Carnegie 15106
412 279-6169

Line: video equip
Arvin/Echo see ad pg 139

ASSOCIATED SALES REPS

403 Fieldstone Ct
Fallstone MD 21047

Line: audio equip

Otari see ad pg 63

AUDIO INNOVATORS

216 Blvd of the Allies
Pittsburgh 15222
412 471-4777

Line: broadcasting equip
Inovonics see ad pg 124
Clear/Com see ad pg 146

BROADCOM

Tilgham at Jefferson
Allentown 18102
215 437-0607

Line: audio & video equip
Inovonics see ad pg 124

COMMERCIAL VIDEO REPRESENTATIVES

12921 Dover Rd
Reistertown MD 21136
301 879-1794

Line: video equipment
Arvin/Echo see ad pg 139

CONTROL ASSEMBLY CORP

1339 Sylvandell Dr
Pittsburgh 15243

Line: video equip

Knox see ad pg 98

ELECTROMEDIA

610 Melwood Ave
Pittsburgh 15213
412 683-5424

Line: video equip
ISI see ad pg 83

HOLT TECHNICAL SVCS

Ste 205 Westgate Mall
Bethlehem 18017
215 865-3775

Line: broadcast equip
Elcom see ad pg 152
UMC see ad pg 150

KILEY ELECTRIC

319 N Pottstown Pike
Exton 19341
215 363-8550

Line: broadcasting equip
Alexander see ad pg 112

STU KRAVITZ

Neshaminy Interplex
Trevose 19047
215 245-8886

Line: video equip
Compact Video see ad pg 162

LERRO ELECTRICAL CORP

3125 N Broad St
Philadelphia 19132
215 223-8200

Line: full line video equip
Conrac see ad pg 136
Knox see ad pg 98
Clear/Com see ad pg 146

L&M ASSOCS

965 A Bristol
Andalusia 19020
215 245-6658

Line: test instruments
Marconi see ad pg 120

LOFSTRUM ELECTRONICS

Empire Bldg
Glassport 15045
412 461-2116

Line: video equip
ISI see ad pg 83

LPB INC

28 Bacton Hill Rd
Frazer 19355
215 644-1123

Line: audio & video equip
UMC see ad pg 150

MULTI MEASUREMENTS INC

1 Madison Ave Ste 06
Warminster 18974
215 675-3082

Line: broadcast components
Lightning Elimination see ad pg 100

JB PARENT CO

Great Northern Bldg
4986 Gateway Dr
Medina OH 44256
216 725-8871

Line: audio equip
Otari see ad pg 63

RICHARD PASS ASSOC

27 Oxford Dr
Lamhorn 19047
215 757-6100

9003 Eastview Rd
Philadelphia 19152

Line: audio equip
Modular Audio see ad pg 90

RON PHENICIE

Danville
717 275-7900

Line: video equip
Anvil Cases see ad pg 84

PIERCE PHELPS INC

2000 N 59 St
Philadelphia 19131
215 879-7180

Line: full line TV production equip
ADDA see ad pg 3
Conrac see ad pg 136
Clear/Com see ad pg 146
Ikegami see ad pgs 15, 143
ISI see ad pg 83

RABAL ASSOC

PO Box 114
Huntingdon Valley 19006

Line: video equip

RO-CEL ELECTRONICS INC

731 Voice of the Theatre Bldg
Rt 8 North
Pittsburgh 15223
412 781-2326

Line: audio components
ESE see ad pg 183
Clear/Com see ad pg 146

RPC ELECTRONICS

620 Alpha Drive
Pittsburgh 15238
412 782-3770

Line: full line of audio/video equip
Conrac see ad pg 136

S&S ASSOC

9 W 3 St
Media 19063
215 565-5388

Boro Line Rd
King of Prussia 19406
215 265-3450

Line: test equip
Marconi see ad pg 120

VAL-TRONICS INC

10 Penn Park Bldg
Pittston 18640
717 655-5937

Line: audio & video equip
Hallikainen see ad pg 140

WAGGONER-VERHILL ASSOCS

3550 Laketon Rd
Pittsburgh 15235
412 241-5202

Line: audio components

ART WHITE

3130 Chalfonte Ave
Bethlehem 18017
215 865-6013

Line: audio equip
Cetec see ad pg 76

Perfect Timing

If You've Wanted To Put Time Code On Your Tape, But Can't Afford The High Cost Of SMPTE:

The ES 280 TIME CODE GENERATOR/READER Is For You!



The new, low-cost way to provide time information on all your tapes, ES 280 generates a time code which includes DAYS, HOURS, MINUTES, SECONDS AND TENTHS OF SECONDS.

With the flip of a switch, ES 280 becomes a reader, to locate that certain place on the tape.

An Amplitude Control knob is located on the rear, so that you can use the 280 with any recorder, Video or Audio.

The 280 uses tones that are compatible with the cue tones used in cartridge recording.

ES 280 COSTS \$500.00

ES 281 (READER ONLY) \$375.00

Contact us or one of our dealers, and we'll tell you how you can get your own 280.



(213) 322-2136

142 SIERRA STREET • EL SEGUNDO, CA 90245

Circle 248 on Reader Service Card

IT STANDS ALONE



TV DEMODULATOR The World's New Standard

Rohde & Schwarz's TV DEMODULATOR, Type EKF 2 reflects the same high quality and performance of the Type AMF — long recognized as the world's standard. The EKF 2 is designed specifically for the U.S. market — and is priced lower.

- Continuously Adjustable — Channels 2-74
- Use Off-Air or at Transmitter
- Envelope and Synchronous Detection
- Sensitivity: 250 μ V — 150 mV
- Zero Ref. Pulse / AFC / AGC
- Ideally Suited for Fixed and Mobile Usage



FROM STOCK!

ROHDE & SCHWARZ

14 Gloria Lane, Fairfield, N.J. 07006
(201) 575-0750 ■ Telex 133310

Circle 249 on Reader Service Card

Reps/Dists

RHODE ISLAND

THE CAMERA MART

456 W 55 St
New York NY 10019
212 757-6977
Line: full TV production equip
Arvin/Echo see ad pg 139

GMI

181 Worchester Rd Rt 9
Natick MA 01760
617 237-6544
Line: audio equip
Otari see ad pg 63

SOUTH CAROLINA

GEORGE BIRX

Stones mountain GA
404 891-5465
Line: video equip
Anvil Cases see ad pg 84

CALHOUN A/V CO

1234 St Andrews Rd
Columbia 29210
803 772-9130
Line: audio & video products, lighting equip

GRAY COMMUNICATIONS

1709 Stuart Ave
Albany GA 31755
912 435-8386
Line: audio & video equip, video systems
Arvin/Echo see ad pg 139

JOHN W HARPER

448 Guilford Rd
Rock Hill 29730
803 366-5045
Line: broadcast equipment
Harris see ad pgs 12, 32, 127

E R LOWDER

7209 Stonehaven Dr
Columbia 29209
803 776-2059
Line: broadcast equipment
Harris see ad pgs 12, 32, 127

TECHNICAL INDUSTRIES

1234 St Andrews Rd
Columbia 29210
803 772-9130
Line: video & lighting equip
ISI see ad pg 83
Clear/Com see ad pg 146

SOUTH DAKOTA

DOUG CURRY

PO Box 1108
Burnsville MN
612 894-3047
Line: video equip
Anvil Cases see ad pg 84

ENTERPRISES INC

6001 N 91 St
Milwaukee WI 53225
414 358-1007
Line: audio equip
Elcom see ad pg 152

TODD COMMUNICATIONS

7360 Ohms Ln
Minneapolis MN 55435
612 835-3080
Line: video equip
Arvin/Echo see ad pg 139

TENNESSEE

AUDIO CONSULTANTS INC

1200 Beechwood Ave
Nashville 37212
615 256-6900
Line: audio equip
ADR see ad pg 130

GEORGE BIRX

Stones mountain GA
404 891-5465
Line: video equip
Anvil Cases see ad pg 84

BROADCAST DISTRIBUTORS

Bible Place
Cleveland 37311
615 472-8200
Line: audio components and equip
Inovonics see ad pg 124

BROADCAST EQUIPMENT & SUPPLY CO

PO Box 3141
Bristol 37620
615 878-2531
Line: full line audio equip
Inovonics see ad pg 124
Clear/Com see ad pg 146

CENTEL SYSTEMS

1444 Shelby Dr
Suite 107
Memphis 38116
901 346-1043
289 Plus Park Blvd
Nashville 37217
615 242-4855
Line: video equip
ISI see ad pg 83
Clear/Com see ad pg 146

GRAY COMMUNICATIONS

6339 E Brainard Rd
Chattanooga 37421
615 894-6860
Nashville
615 883-9175
Line: full line broadcast equip
Arvin/Echo see ad pg 139

RALPH HUCABY

1331 Otter Creek Rd
Nashville 37215
615 373-0231
Line: video equip
Asaca see ad pg 59

RADFORD ASSOC

1331 Otter Creek Rd
Nashville 37215
615 373-0231
Line: full line broadcast equip
Asaca see ad pg 59

SPHERE AUDIO SALES

478 Devens Dr
Brentwood 37027
615 794-0155
Line: full line audio equip
BTX see ad pg 176

TECHNICAL INDUST

401 Spence La
Nashville 37210
615 256-0800
Line: video equip
ISI see ad pg 83

TECHNICON

101 Cumberland Ave Suite 106
Madison 37115
615 865-6040
Line: audio equip
Otari see ad pg 63

WILSON AUDIO SALES

Rt 3 Barrell Springs Hollow Rd
Franklin 37064
615 794-0155
Line: audio equip
BTX see ad pg 176
dbx see ad pg 99

The end of the endless loop.

Eumig's new FL-1000 makes cassettes the broadcast medium.

The Eumig FL-1000, an extraordinary new cassette tape deck, has started a revolution in the world of broadcasting. We believe—and radio engineers agree—that it will soon make the cassette the standard tape format in the broadcast industry.

The FL-1000 is the world's first computer-inter-faceable cassette recorder. Up to sixteen FL-1000 decks can be controlled by any 8-bit computer. Some of the decks can be used for commercials; others for news and weather; still others for music and station ID's. And the location of every item on every cassette can be stored at the beginning of each tape and then in the computer, so *any* sequence can then be played back—automatically, with no human intervention, all day and all night long.

Watching a bank of FL-1000's working together

is an awesome experience. One deck is rewinding while another is playing, and still another is moving in fast-forward to locate the next selection. Meanwhile, other decks are copying from a network feed and recording an air check.

The technology of the FL-1000 is so advanced that half a dozen units can do the work of more than 100 individual cartridge players—plus several reel-to-reel recorders. And they do it better, at far less cost, with sound quality comparable to that of the finest open-reel equipment. And the Eumig FL-1000's have none of the mechanical problems that plague endless-loop broadcast cartridges.

To see the end of the endless loop, call Eumig about the new FL-1000. Once you see and hear this amazing new recorder in action you'll agree that this is the long-awaited deck that will make cassettes the standard medium in the broadcast industry.

eumig[®]

Eumig (USA) Inc., Lake Success Business Park, 225 Community Drive,
Great Neck, New York 11020, (516) 466-6533

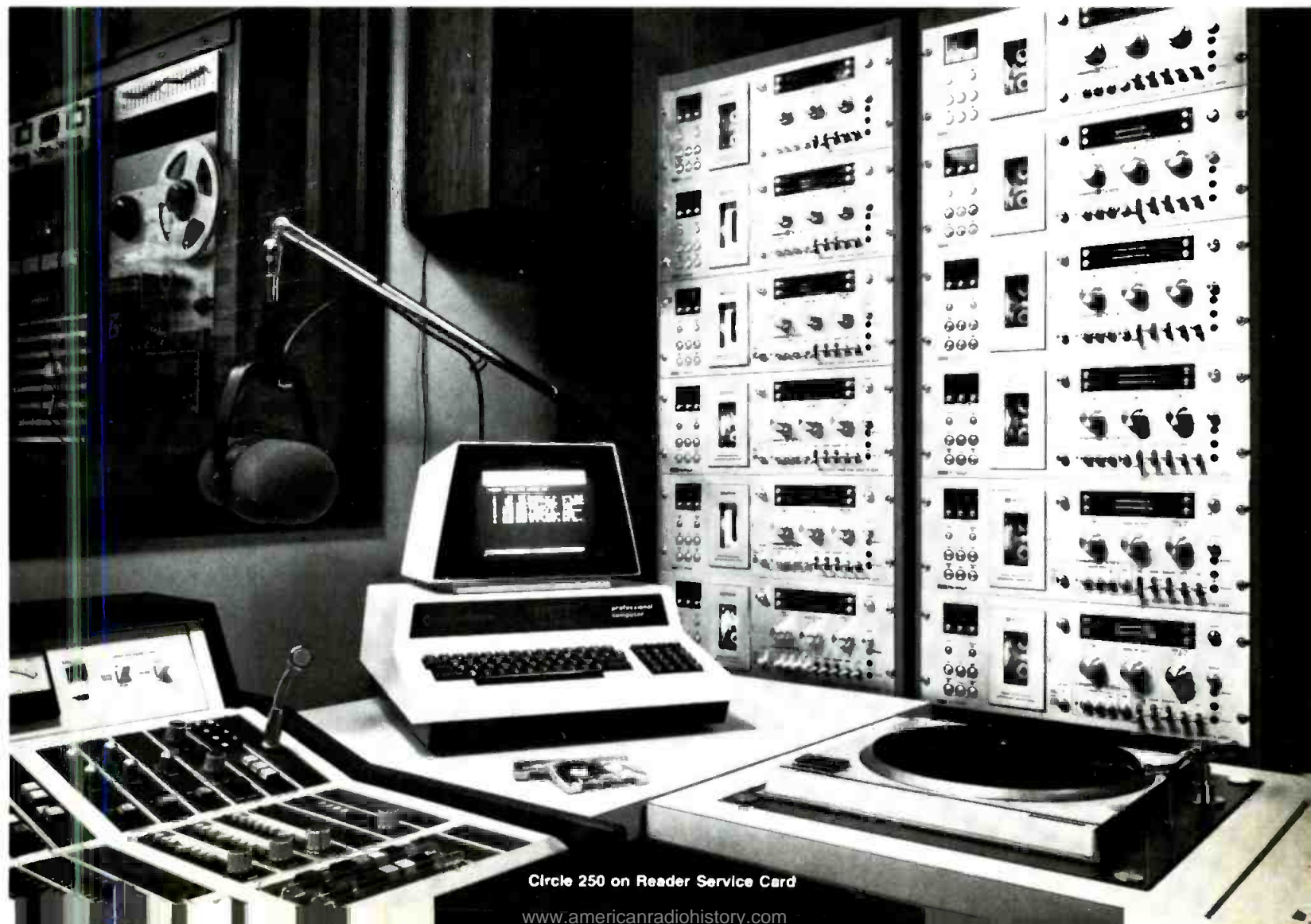

Circle 250 on Reader Service Card

www.americanradiohistory.com

Reps/ Dists

TEXAS

ABADON/SUN INC
PO Box 6520
San Antonio 78209
512 824-8781
Line: audio equip
ADR see ad pg 130

BOB AMOS & ASSOCS
PO Box 3247
Irving 75061
214 827-8232
Line: full line broadcast equip
Sintronic see ad pg 192

MERLE ARNOLD
13773 N Central Expwy
Dallas 75243
214 783-0044
Line: video equip
Compact Video see ad pg 162

AUDIO VIDEO ENTERPRISES
7950 Westglen Dr
Houston 77063
713 977-1520
Line: audio & video equip
ISI see ad pg 83

BRADENCO
11500 Stemmons
Dallas 75229
214 243-7261
Line: test instruments
Allen Avionics see ad pg 145
Marconi see ad pg 120

BROADCAST SYSTEMS INC
A103 Smithpark
8222 Jamestown Rd
Austin 78758
512 836-6014
Line: audio equip
Conrac see ad pg 136

COLLINS RADIO GROUP
1225 North Alma
Richardson 75080
214 690-5000
Line: full line broadcast equip
Inovonics see ad pg 124

TOM COPELAND
10523 Maplegrove
Dallas 75218
214 328-4944
Line: broadcast equip
Cetec see ad pg 76

CROUSE-KINZEY CO
3507 W Vickery Box 9830
Ft Worth 76107
817 737-9911
Line: audio components
LPB see ad pg 170
Elcom see ad pg 132

B CULBERTSON
Suite 1 at the Registry
6350 LBJ Fwy
Dallas 75240
214 387-1389
Line: video equip
Telemet see ad pg 165

VICTOR DUNCAN INC
2657 Fondren Ave
Dallas 75206
214 369-1165
Line: full line TV production equip
Clear/Com see ad pg 146
Victor Duncan see ad pg 149
Frezzolini see ad pg 132

DYMA ENGINEERING
PO Box 1697
Taos NM 87571
505 758-2686
Line: audio equip
Elcom see ad pg 152

LONDON T ENGLAND
5210 Kinglet
Houston 77035
713 977-2411
Line: broadcast equip
Harris see ad pgs 12, 32, 127

STEVE FEST
San Antonio
512 495-0712
Line: video equip
Anvil Cases see ad pg 84

CLIFF FRAZIER
Dallas
214 324-8117
Line: video equip
3M Video see ad pgs 56, 117

GUARANTEE RADIO & SUPPLY
1314 Iturride
Laredo 78040
512 723-6913
Line: audio equip
UMC see ad pg 150

INDUSTRIAL AV INC
PO Box 25127
2617 Bissonet
Houston 77005
713 524-1956
Line: video equip
Conrac see ad pg 136
ISI see ad pg 83

JBS ENTERPRISE
7817 Charter Oak Crt
Fort Worth 76179
817 237-4620
Line: broadcasting equip
Alexander see ad pg 112

VERN KILLION
707 Rosewood
Spring 77381
713 977-2411
Line: broadcast equip
Harris see ad pgs 12, 32, 127

LYKES ELECTRONICS
PO Box 26816
Houston 77207
Line: audio & video equip
Clear/Com see ad pg 146

MAGNETIC MEDIA
1314 N Lee
Odessa 79761
915 322-4341
1146 Halm Ste 103
San Antonio 78216
512 349-9313
2211 E Missouri
El Paso 79903
915 533-7205
5555 N Lamar J-115
Austin 78751
512 451-0138
4119 W 34 St
Fleetwood Shopping Ctr
Amarillo 79109
806 352-5932
Line: full line broadcast equip
ISI see ad pg 83

MARKETING PROFESSIONALS
144 Melmont
Controe 77302
713 273-3356
Line: audio equip
Eumlig see ad pg 185



516-694-8963 EAST
213-247-9247 WEST

VINTEN *Camera Mounting*
DIGIVISION *PROMPTING*
RICHMOND *Audio Mixers*

39 Cain Drive Plainview, N.Y. 11803

Circle 251 on Reader Service Card

TRANSLATORS

VHF - TV	FM	UHF TV
SOLAR POWERED	MICROWAVE FED	SATELLITE FED

ALSO REPAIR PARTS AND UP DATING KITS FOR ALL ADLER, LITTON AND KEITH ANDERSON TRANSLATORS

Television Technology Corporation

5970 West 60th Avenue • Arvada, Colorado 80003
303-423-1652 / TWX 910-938-0396

Circle 252 on Reader Service Card

INSTALLING T.V. EQUIPMENT ?

YOU NEED

SERIES 5.25 VIDEO or PULSE DELAY UNITS

from



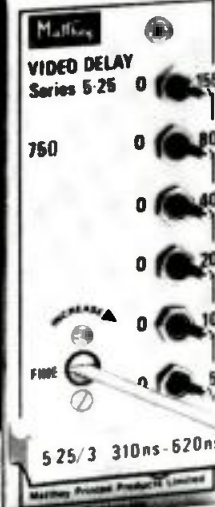

- 75Ω
- 10 to 2460ns (VIDEO)
- 5 to 4965ns (PULSE)
- To fit 19" racks
- Plug straight into on air video
- Used Nationwide

MORE STABLE THAN CABLE

±4ns TRIM

Television Equipment Associates, Inc.

BILL PEGLER, Director
BOX 240 SOUTH SALEM, N.Y. 10590
Tel. 914-763-8893 Twx: 710-575-2600

Circle 253 on Reader Service Card

CLEANER, BRIGHTER, LOUDER.

OPTIMOD-AM permits progressive LW, MW, or SW broadcasters with quality plants to broadcast a standout signal with improved coverage.

The signal is processed for common automobile, table and portable radios to achieve outstanding speech intelligibility, musical definition and freedom from distortion.

And the versatile new OPTIMOD-FM Model 8100A is even cleaner, brighter and louder than the industry-standard Model 8000A it replaces.

The new 8100A was computer designed and refined by hundreds of hours of listening to set the new quality standard for FM in the 80's.

AM or FM—OPTIMOD creates sound that dominates the dial. For all the details, call Toll Free (800) 227-4498, In California (415) 957-1067, or write for the name of the Orban Broadcast Dealer nearest you.

orban

Orban Associates Inc. 645 Bryant Street, San Francisco, CA 94107 Telex: 17-1480 Cable: ORBANAUDIO



For more information on Optimod-AM Circle 150 on Reader Service Card

For more information on Optimod-FM Circle 254 on Reader Service Card

Reps/Dists

Texas continued

MARTIN ZIENKOSKY BROWNE & ASSOCS

3801 Kirby, Suite 834
Houston 77006
713 523-4333
13731 Omega Rd
Dallas 75240
214 233-5535
PO Box 9748
Austin 78766
512 454-4371
4203 Beltway
Dallas 75234
214 233-5535
16502 Northchase Dr Ste E
Houston 77060
713 448-0881
Line: full line of audio & video equip
Ikegami see ad pgs 15, 143
NEC see ad pg 81
TFT see ad pg 151
UMC see ad pg 150

RA MAYES

PO Box 1021
725 S Central Expwy Ste C10
Richardson 75080
214 235-3043
9449 Briar Forest Dr #3511
Houston, 77063
713 783-3856
Line: broadcast components
Lightning Elimination see ad pg 100

MIDCITIES COMMUNICATIONS

PO Box 3497
Arlington 79912
915 584-6903
Line: audio equip
Clear/Com see ad pg 146

MIDWEST TELE COMMUNICATIONS

15046 Beltway Dr
Dallas 75240
214 387-2755
5200 Mitchelldale Ste F28
Houston 77092
713 686-9278
Line: audio, video, lighting equip
Anton/Bauer see ad pg 93
Conrac see ad pg 136
ISI see ad pg 83
Clear/Com see ad pg 146

MZB & ASSOC

4203 Beltway Dr
Dallas 75240
214 233-5535
Line: audio equip
Ramko see ad pgs 28-29, 154-155

BOBB PARTRIDGE & PETER BLAIR

Rte 4 Box 197
Terrell 75060
214 222-2131
Line: audio equip
Studer Revox see ad pg 89

SAVCO

PO Box 427
Richardson 75080
214 234-1841
Line: radio and TV equip
ESE see ad pg 183

SPECTRA SALES

777 S Central Expwy
Richardson 75080
214 234-3600
Line: RF equip
Electro Impulse see ad pg 177

SUDDUTH MANUFACTURERS REPS

845 39 SE
Paris 75460
214 785-5764
Line: full line video equip
ADDA see ad pg 3
Asaca see ad pg 59

Datatek see ad pg 179
Knox see ad pg 98
Skotel see ad pg 108
TEA see ad pgs 148, 186, 199

TENICKE & ASSOC

6432 Westchester
Houston 77005
713 663-6432
Line: audio equip
Otari see ad pg 63

VIDEO SYSTEMS

2123 W Governors Circle
Houston 77092
2741 34 St Lubbock 79400
806 792-2325
3817 Ross Ave
Dallas 75204
8801 Tradeway St
San Antonio 78217
Line: full line TV production equip
Arvin/Echo see ad pg 139

WESTERN INTL BROADCASTING & ADVERTISING

El Paso Natl Bank Bldg Ste 9K
El Paso 79901
915 533-4937
Line: broadcast equip
UMC see ad pg 150

WHALIN'S PRO AUDIO SALES

2910 Buena Vista
Arlington 76010
817 640-0261
Line: full line audio & recording equip
Inovonics see ad pg 124

UTAH

B.B ELECTRONIC PRODS

1800 SW Temple
Salt Lake City 84115
801 486-3943
Line: audio equip
Otari see ad pg 63

DIDIER/DENVER

1777 S 2600 E
Salt Lake City 84108
801 484-0915
4665 Kipling
Wheat Ridge CO 80033
303 622-6666
Line: audio & video equip
TFT see ad pg 151
Asaca see ad pg 59

RICHARD HUNT

4185 S 300 West
Suite #4
Ogden
801 394-3401
Line: broadcasting equip
Alexander see ad pg 112

LEE LATHAM

Salt Lake City
801 484-0915
Line: video components
TEA see ad pgs 148, 186, 199

RA MAYES CO

PO Box 456
256 E Casa Loma Dr
Centerville 84014
801 292-6781
Line: broadcast components
Lightning Elimination see ad pg 100

RIA INC

50 East Malvern
Salt Lake City 84100
801 486-8822
Line: broadcast equip
NEC see ad pg 81
Skotel see ad pg 108

SKAGGS TELECOMM SVC

312 Bearcat Dr
Salt Lake City 84125
801 487-4531
Line: broadcast equip
Conrac see ad pg 136
Ikegami see ad pgs 15, 143

From Marconi to Moseley;

An Industry of Ideas

When Guglielmo Marconi first sent electrical waves across his father's garden, no one really could have guessed the world would be so dependent on his spark of genius. That's the way it is with great innovators.

That's the way it is with Moseley, too. We've got a pretty good idea of where the broadcast industry is heading. That's why we developed the new TCS-2A Telecontrol System. It has all the features that have made Moseley a leader in this field and yet is designed for today's broadcaster. In fact, the TCS-2A is the simplest, economical 8-channel remote control system (with 8 fully independent command, status and telemetry functions) on the market, yet utilizes microprocessor-based technology. The TCS-2A can be used for AM/FM broadcast transmitters, ENG and earth station remote sites, and industrial applications. Combine it with the new model PCL-505A/C STL system with improved high RF density performance and you've developed an operation that's state-of-the-art.

Of course Moseley won't stop with just the TCS-2A. That wasn't Marconi's style and it's not ours!

For more information on all the Moseley Innovators including the Model TCS-2A, PCL-505A/C, MRC-1, DCS-2A, TRI-1, TAL-320, TFL-280B and TGR-340 contact us now.

Santa Barbara Research Park
111 Castilian Drive
Goleta, California 93017
(805) 968-9621
Telex: 658448 Cable: MOSELEY



See us at NAB Booth 505.

SEE US AT NRBA BOOTH 403-404

MOSELEY ASSOCIATES, INC.

A Flow General Company



**fact:
the SM63 looks
(and sounds) great
in front of people...
and cameras!**

NEW!



**SM63
Omnidirectional
Dynamic
Microphone
(actual size)**

Take it from the professionals

A top-quality Shure microphone makes a measurable difference in upgrading sound. Now, Shure has added a new microphone designed to upgrade the *appearance* of your act, as well as the sound. The SM63 is a top-quality omnidirectional microphone with high output and clear, crisp sound quality—an innovative blending of smaller size, handsome appearance, and truly noteworthy broadcast-quality performance. Highly effective pop protection, low handling noise and very low profile (so it won't obscure the performer's face) make it the perfect choice for on-camera applications. The SM63 omnidirectional dynamic microphone measures just 5¹/₁₆ in. long, 1¹/₄ in. in diameter and weighs only 2.8 ounces with no compromise in Shure's standard of reliability. It offers twice the voltage sensitivity of our own SM61 (6 dB) and features a humbucking coil for superior rejection of electromagnetic hum (up to 20 dB better than competitive units) and an elastomer isolation shock mount for minimized handling noise. The new SM63 also features the Shure-developed VERAFLX[®] dent resistant grille and a smooth satin finish perfect for on-stage and on-camera applications. Send for complete literature on all Shure professional microphones—including the new SM63. (Please let us know your microphone application.)

SPECIFICATIONS

Frequency Response: 50 to 20,000 Hz
Polar Pattern: Omnidirectional
Impedance: 150 ohms
Output Level (at 1,000 Hz): Open Circuit Voltage (0 dB = 1 volt per microbar) – 76.0 dB (0.16 mV) Power Level (0 dB = 1 milliwatt per 10 microbars) – 56.5 dB
Hum Pickup (typical at 60 Hz): 13 dB equivalent SPL in 1 millioersted field
Shock Mount: Patented internal vibration isolator
Case: Champagne finish aluminum with VERAFLX[®] grille
Dimensions and weight: 5¹/₁₆ in. long, 1¹/₄ in. in diameter; 2.8 ounces

The Sound of the Professionals



Shure Brothers Inc., 222 Hartrey Ave., Evanston, IL 60204
In Canada: A. C. Simmonds & Sons Limited
Manufacturers of high fidelity components, microphones, sound systems
and related circuitry.

Circle 255 on Reader Service Card



**WHEN
IS LESS
ANTENNA
MORE
ANTENNA?**

**WHEN IT'S
OUR NEW
SUPERPOWER
FM BROADCAST
ANTENNA.**

Finally, here's the answer to the need for high power antennas using a minimum number of bays. Each of the three models in our new series of circularly polarized FM antennas features much lower Q than the previous designs. And, each

has massive 3 $\frac{1}{8}$ inch two-tube baluns which provide much wider match bandwidth than loop coupled designs.

These new antennas actually offer a VSWR of 1.1:1 for approximately 500 KHz. two and one half times the bandwidth

of standard, circularly polarized low power and high power antennas. What's more, increased bandwidth minimizes the impedance change due to icing.

Can we tell you more? Write today for all the details: Phelps Dodge Communications Company, Route 79, Marlboro, New Jersey 07746. (201) 462-1880

**phelps
dodge**
Communications Company

Circle 256 on Reader Service Card

www.americanradiohistory.com

Reps/Dists

Utah continued

SKAGGS VIDEO SALES

4865 Wiley Post Way
Salt Lake City 84116
801 539-1420
Line: video equip
Ikegami see ad pgs 15, 143

SOUND ELECTRONICS SERVICES INC

430 S State St
Salt Lake City 84111
801 363-3976
Line: audio equip
Clear/Com see ad pg 146

VERMONT

APPLIED MEASUREMENTS

Rd #1 Hillside St
N Bennington 05257
802 442-2222
Line: broadcast components
Lightning Elimination see ad pg 100

GMI

181 Worcester Rd Rte 9
Natick MA 01760
617 237-6544
Line: audio equip
Otari see ad pg 63

PROFESSIONAL VIDEO SYSTEMS

1616 Soldiers Field Rd
Boston MA 02135
617 254-2102
Line: video equip
Arvin/Echo see ad pg 139

STEVE THACHER

Fishkill NY
914 896-5860
Line: video equip
Anvil Cases see ad pg 84

VIRGINIA

ALPHA AUDIO

2049 W Broad St
Richmond 23220
804 358-3852
Line: full line audio equip
Inovonics see ad pg 124

ASSOCIATED SALES REPS

403 Fieldstone Ct
Fallstone MD 21047
301 877-7300
Line: audio equip
Otari see ad pg 63

BOB DIX

PO Box 31
Marion 24354
703 783-2001
Line: broadcast equip
Cetec see ad pg 76

DAVID GREEN

21 N Wirt St
Leesburg 22075
703 777-8660
Line: audio components & equip
Aristocart see ad pg 168
ESE see ad pg 183
Hallikainen & Friends see ad pg 140
Inovonics see ad pg 124
UMC see ad pg 150
Ikegami see ad pgs 15, 143

MIDWEST TELE COMMUNICATIONS

1395 Air Rail Ave
Virginia Beach 23455
804 464-6256
Line: audio video & lighting equip
Clear/Com see ad pg 146
Anton/Bauer see ad pg 93
ISI see ad pg 83
Videotek see ad pg 146

RON PHENICIE

Danville PA
717 275-7900
Line: video equip
Anvil Cases see ad pg 84

PROFESSIONAL PRODUCTS INC

4964 Fairmont Ave
Bethesda MD 20014
301 657-2141
Line: full line video products, lighting equip
Arvin/Echo see ad pg 139

QT ELECTRONICS

7127 Little River Turnpike
Annadale 22003
703 941-4242
Line: video, transmitting & measuring equip
Rohde & Schwarz see ad pgs 13, 184

SPHERE ASSOC

11250-14 Roger Bacon Dr
Reston 22090
703 471-1230
Line: full line audio equip
BTX see ad pg 176
dbx see ad pg 99

ROBERT SLYE ELECTRONICS

3415 N Washington Blvd
Arlington 22201
703 525-7272
Line: video equip, lighting equip
Conrac see ad pg 136

WASHINGTON

BENNETT ENGINEERING CO

Box 76
Mercer Island 98040
206 232-3550
Line: full line TV production equip
Anton/Bauer see ad pg 93
Ikegami see ad pg 15, 143

BROADCAST SUPPLY WEST

2711 Locust Ave W
Tacoma 98466
206 565-2301
Line: broadcast products
Ikegami see ad pgs 15, 143
Inovonics see ad pg 124

BSW

7012 27 St W
Tacoma 98466
206 565-2301
Line: audio equip
Aristocart see ad pg 168

COMPONENTS WEST

4515 W 10 St
Renton 98055
206 271-5252
Line: video equip
Allen Avionics see ad pg 145

CUSTOM VIDEO SYSTEMS

1752 15 Ave NE
Seattle 98115
206 524-1026
Line: video & lighting equip
Arvin/Echo see ad pg 139
Clear/Com see ad pg 146

FLEE HART & SULLIVAN INC

10109 Aurora Ave N
Seattle 98133
206 522-1533
Line: broadcast equip
Knox see ad pg 98

GM GILLET & ASSOCIATES

PO Box 99035 2507
W Viewmont Way W
Seattle 98199
206 284-3344
Line: broadcast components
Lightning Elimination see ad pg 100

FRED HARKNESS

3123 56 St NW #14
Gig Harbor 98335
206 858-9294
Line: broadcast equip
Cetec see ad pg 76

BILL HARLAND

36934 4 Ave SW
Federal Way 98003
206 838-9593
Line: broadcast equip
Harris see ad pgs 12, 32, 127

HOOD ENGINEERING

12835 Bellevue — Redmond Rd
Bellevue 98005
206 453-9375
Line: test & measuring equip
Marconi see ad pg 120

ARVA HUDSON

PO Box 1512
Bellevue 98009
206 822-1810
Line: broadcasting equip
Alexander see ad pg 112

IGM/NTI

4041 Home Rd
Bellingham 98225
206 733-4567
Line: full line audio equip
Aristocart see ad pg 168

K&M COMMUNICATIONS

1916 NE Ballinger Way
Seattle 98155
206 364-9911
Line: video equip
ISI see ad pg 83
Clear/Com see ad pg 146

MARCOM

1916 NE Ballinger Way Ste B
Seattle 98155
206 364-9911
Line: audio equip
NEC see ad pg 81
TFT see ad pg 151

MATRIX CORP

7417 Greenwood Ave N
Seattle 98103
206 789-5990
Line: audio equip
dbx see ad pg 99

NORTHSHORE MARKETING (NOR/MARK)

158 04 NE 65 St
Redmond 98052
Line: audio equip
Otari see ad pg 63

NORTHWEST ELECTRONICS

E 730 First Ave
Spokane 99220
509 535-7652
Line: video equip
ISI see ad pg 83

NORTHWEST INDUSTRIES

5518 Empire Way-S
Seattle 98118
206 725-1400
Line: full line video equip
Conrac see ad pg 136

NUCOM ASSOCIATES

PO Box 243
Edmonds 98020
206 364-9911
Line: video & audio equip

JOHN NUTTING

Seattle
206 364-9911
Line: video components
TEA see ad pgs 148, 186, 199

PUGET SOUND AUDIO

5105 N 46th St
Tacoma 98407
206 759-4701
Line: broadcasting equip

RJ ASSOCIATES

702 N 35 St
Seattle 98103
206 632-8800
Line: audio equip
Eumlg see ad pg 185

TASCO

12835 Bellevue-Redmond Rd
Bellevue 98005
206 453-1414
Line: test equip, broadcast equip
Marconi see ad pg 120

TA TRACK AUDIO

33753 9th Ave So
Federal Way 98003
206 838-4460
Line: audio components
ESE see ad pg 183

WEST VIRGINIA

COMMERCIAL VIDEO REPS

2637 N Charles St
Baltimore MD 21218
301 235-9120
Line: video equip
Arvin/Echo see ad pg 139

CRV SYSTEMS

860 Adams Ave
Huntington 25704
304 525-2633
Line: video equip
ISI see ad pg 83

MIDWEST TELE COMMUNICATIONS

300 First Ave
Nitro 25143
304 722-2921
Union Bldg 12th Flr
Charleston 25321
304 343-8874
Line: full line TV production equip
Ikegami see ad pgs 15, 143
ISI see ad pg 83
Clear/Com see ad pg 146

JB PARENT CO

Great Northern Bldg 4986 Gateway Dr
Medina OH 44256
216 725-8871
Line: audio equip
Otari see ad pg 63

RICK PARENT

Columbus OH
614 890-8623
Line: video equip
Anvil Cases see ad pg 84

WISCONSIN

CDP INDUST

801 Hwy 67 — Box 115
Ashippun 53003
414 474-4112
Line: broadcast equip
Asaca see ad pg 59

DOUG CURRY

PO Box 1108
Burnsville MN
612 894-3047
Line: video equip
Anvil Cases see ad pg 84

ELECTRONIC PRODUCTS

PO Box 367
Meguon 53092
414 241-3020
Line: broadcasting equip
Alexander see ad pg 112

ENTERPRISES INC

6001 N 91 St
Milwaukee 53225
414 358-1007
Line: audio equip
Elcom see ad pg 152
Ramko see ad pgs 28-29, 154-155

Reps/ Dists

Wisconsin continued

FULL COMPASS SYSTEMS LTD

6729 Seybold Rd
Madison 53719
608 271-1100

Line: audio equip
Clear/Com see ad pg 146
Inovonics see ad pg 124

ROBERT GORJANCE

3320 Ivy Ln
Racine 53402
414 639-7689

Line: broadcast equip
Harris see ad pgs 12, 32, 127

CHRIS GROTH BROADCAST EQUIP SRV

PO Box 94 Eastern Ave
Ft Atkinson 53538
414 563-7236

Line: audio equip
Hallikainen see ad pg 140

KENNETH W MYERS CO

3055 N Brookfield
Brookfield 53005
414 784-3790

Line: audio & video equip
Marconi see ad pg 120

TODD COMMUNICATIONS

1122 Queens Way West
Nekoosa 54457
715 325-2573

Line: video equip
Ikegami see ad pgs 15, 143
Arvin/Echo see ad pg 139

VIDEO IMAGES

1220 W Adler Lane
W Allis 53214
414 475-0111

811 Mayfair Ave
Madison 53714
608 241-5281

Line: full line video equip
Conrac see ad pg 136
ISI see ad pg 83

CANADA

APPLIED ELECTRONICS

299 Evans Ave
Toronto M8Z 1K2
416 252-3761

Bay No 1
4519 12 St NE
Calgary, Alberta
403 277-8600
Line: full line radio & TV equip
Datatek see ad pg 179
Ikegami see ad pgs 15, 143
Viscount see ad pg 152

AUVINIC LTD

1280 Lachaine St
St Vincent de Paul Que H7C 2N7
514 661-5120

Line: audio & video equip
Conrac see ad pg 136
Skotel see ad pg 108

CALDWELL A/V EQUIP CO

1080 Bellamy Rd N
Scarborough Ontario N1H 1H2
416 438-6230

Line: full line audio & video equip
Elcom see ad pg 152
Ramko see ad pgs 28-29, 154-155

COMAD COMMUNICATIONS LTD

91 Kelfield SF Unit 5
Rexdale Ont M9W 5A3
416 245-1734

Line: audio components & video equip
ESE see ad pg 183
Ikegami see ad pgs 15, 143
Knox see ad pg 98

ELECTRO & OPTICAL SYSTEMS

31 Progress Ct
Scarborough Ont
416 439-9333

Line: video equip
MCI/Quantel see ad pg 101
Arvin/Echo see ad pg 139

GLETRONIX LTD

160 Duncan Mills Rd
Don Mills Ont M3B 1Z5
416 444-8497

Line: full line audio & video equip
Conrac see ad pg 136

LEADER SOUND

195 W 7 Ave
Vancouver BC V5Y 1L8
604 685-6043

Line: audio equip
ADR see ad pg 130

MSC ELECTRONICS LTD

847 Dale Blvd
Winnipeg Manitoba R3R1R4
204 895-8380

236 5 Bachard
Carignan J3L 4E9
514 658-0665
254 Wildcat Rd
Downsview Ont M3J 2N5
416 661-4180
412 Oakridge Way
Calgary SW Alberta T2V 1T4
403 281-3111

Line: full line broadcast equip
LPB see ad pg 170
Telemet see ad pg 165
TFT see ad pg 151
UMC see ad pg 150

NATIONAL ELECTRONIC AGENCIES LTD

2137 Commercial Dr
Vancouver BC V5N 4B3

604 253-0811

Line: video equip
Viscount see ad pg 152

NORTEC WEST LTD

325 W 5 Ave
Vancouver BC V5Y 1J6
604 872-8525
7056 A Farrell Rd
Calgary Abta T2H 0T2
403 252-8141

Line: audio & video equip
Conrac see ad pg 136
MCI/Quantel see ad pg 101
Skotel see ad pg 108

OAKWOOD AUDIO LABS LTD

10874 97 St
Edmonton Abta T5H 2M5
403 424-2186
12-1638 Pandosy St
Kelowna BC V1Y 1P5
604 763-5222
654 King Edward St
Winnipeg Manitoba R3H 0P2
204 775-8231

Line: audio equip
Ramko see ad pgs 28-29, 154-155

RADIO SERVICES INC

2500 Bates Rd
Montreal H3S 1A6
514 342-4503

Line: professional audio & video equip
BTX see ad pg 176

VIDEO AIDS OF CANADA

PO Box 16 Port Credit Station
Mississauga L5G 4L5
Line: video equip
Video Aids see ad pg 197

WACKID RADIO TV LABS LTD

312 Parkdale Ave
Ottawa Ont K1V 1G3
613 728-1821

Line: video equip
Ikegami see ad pg 15, 143

CAMRAPROMPTER

Cinema Products' unique film/video camera prompting system: low-cost, compact, light-weight, easy to set up and simple to operate!

- Bright, easy-to-read script. Ultra-silent operation.
- The *Camraprompter** utilizes a clear acrylic optical flat (set at a 45° angle in front of the camera lens) which acts as a mirror reflecting the back-lit script "scrolls." The system functions with virtually no light loss to the lens.

- A small remote control unit provides continuously variable speed control (forward or reverse). Permits convenient self-pacing by "on camera" subject. Script can also be easily read and controlled from the side of the *Camraprompter* unit.
- Entire system is powered by standard 12V battery pack or belt.

For further information, please contact:

cinema E products
CORPORATION

Technology in the Service of Creativity
2037 Granville Avenue, Los Angeles, California 90025
Telephone (213) 478-0711 • (213) 477-1971 • Telex: 69-1339

*Patents pending

Circle 228 on Reader Service Card

JOIN THE CSI NETWORK



Now you too can become a member of one of the fastest growing networks in radio broadcasting. CSI's more than 450 satisfied transmitter owners.

You can share the advantage of superb quality craftsmanship and dependable service others expect from CSI.

CSI . . . the network you'll be glad to be affiliated with.



380C South Congress Avenue • Boynton Beach, Florida 33435 • Phone 305/737-5626 • Telex 513458

IN CANADA, contact Peter MacFarlane, CSI Electronics, Pointe Claire P.Q. Phone 514-695-8130 or 514-484-6601.

Circle 257 on Reader Service Card

Beyer. We make the best broadcast mics, too.

In recording studios, concert halls and theatres worldwide, Beyer is the premier name in microphones. Loved by performers and respected by engineers.

Now that same Beyer quality is available in a full line of innovative broadcast microphones, to meet every need and solve every problem.

The Beyer MCE 5 is the world's smallest electret condenser and provides true broadcast-quality audio from a 7 x 23 mm. cylinder weighing just 6.5 grams. It has wide frequency response, but is immune to most body noises. And you can hide it almost anywhere and connect it to a cable or a wireless transmitter.

If you can't get the mic near the sound source, try our Beyer MC 717 shotgun. It has a directional gain of at least 20 dB and a 40-20K frequency response.

The MC 717 is part of a modular condenser mic system consisting of six different transducer capsules plus amplifiers and phantom power supplies that can be perfectly tailored for a wide range of broadcast situations. They're all ruggedly built to handle ENG as well as studio work and can accept temperatures up to 160° and 99% humidity.

Other mics include: the M 55 – an omni-directional dynamic mic that is especially suited for reporters and field interviews; the M 69 – a uni-directional hypercardioid dynamic mic that is perfect for announcers on TV and a studio mic in radio stations; the M 88 – a uni-directional cardioid dynamic mic with warm and full bass response that is ideal for booth or radio announce. This is easily one of the best mics in the business – with a special suspension that eliminates transmitted noise if hand held. Our M 201 is another microphone with excellent vocal characteristics that is favored by singers and reporters alike.

There are many more mics in the Beyer line, plus stands, booms, headsets and accessories. Visit your local Beyer distributor for more information and specs.



MCE 5



M 55

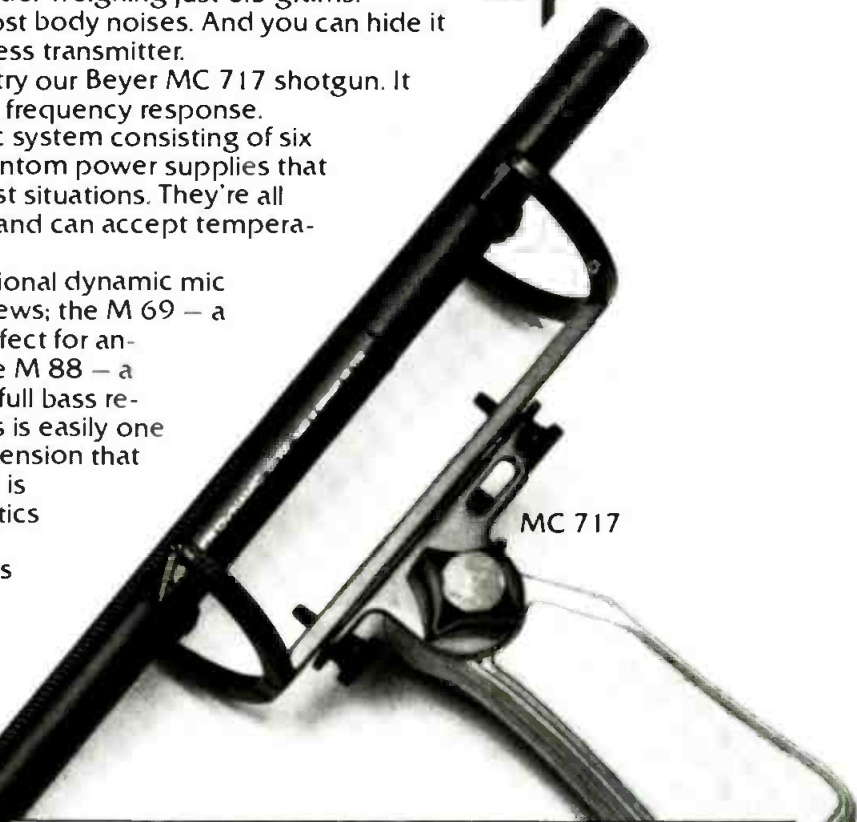

MC 717

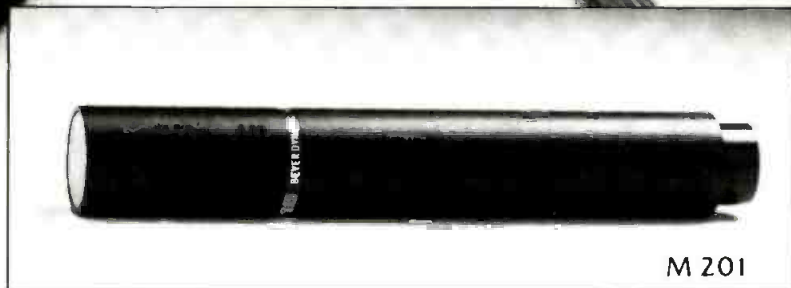

M 201



M 88

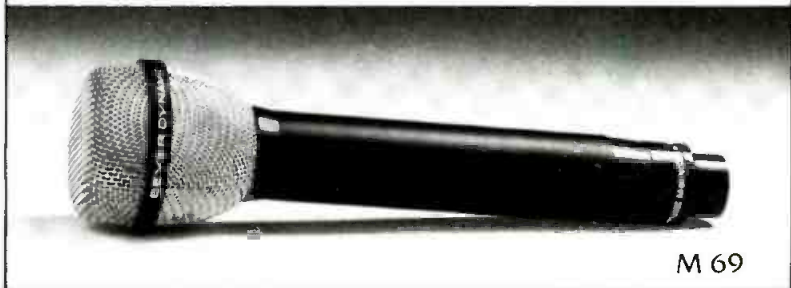

M 69

Beyer
Dynamic

BEYER DYNAMIC, INC.

5-05 Burns Avenue, Hicksville, NY 11801 • (516) 935-8000
In Canada, H. Roy Gray, Ltd.

Circle 258 on Reader Service Card

INTERPRETING THE **FCC** RULES & REGULATIONS

FCC Eliminates Major Cable TV Rules

By Frederick W. Ford and Lee G. Lovett; Lovett Ford and Hennessey, P.C., Washington, D.C.

IN A RECENT DECISION which will certainly have a major impact upon TV broadcasters, the Federal Communications Commission has voted to eliminate its distant signal rules for cable television systems, as well as rules covering exclusivity of syndicated programs. On July 23, 1980, the *Washington Post* quoted National Association of Broadcasters president Vincent T. Wasilewski as terming the ruling "ridiculous." However, Thomas Wheeler, president of the National Cable Television Association, hailed the decision as a "monumental victory for consumers who desire additional choices in television and viewing." Who is correct? This article will briefly examine the decision, as well as events leading up to it and possible ramifications.

Background

The FCC's signal carriage rules are those regulations which prescribe those broadcast TV stations which can and cannot be carried by cable systems. The Commission first promulgated rules which limited the importation of distant independent signals in 1966. Six years later, the FCC revised the rules on distant signals and formulated the syndicated exclusivity rules.¹ As a result, systems operating within the top 100 TV markets generally could import no more than two distant signals. In the top 50 markets, three distant independent signals could be carried if there were no local independent stations. In smaller markets, cable systems were limited to one distant TV signal. However, in 1977, the FCC exempted cable television systems with fewer than 1000 subscribers from the signal carriage limitations.

The syndicated exclusivity rules, also enacted in 1972, barred the carriage of certain individual programs or series of programs available to viewers from distant signals. If those programs were also aired on local TV stations, even if not aired at the same time, the distant signal could be blacked out. Systems located within the 35-mile radius of the top 50 television markets could be required, at the

request of the local station or copyright holder, to delete the distant signal carriage of syndicated programming which was under exclusive contract to the local broadcaster. Systems in the second 50 television markets could import such syndicated programs only under very limited circumstances. Systems of fewer than 1000 subscribers were exempted after 1977.

In November, 1976, the FCC began a review of the rules which limited carriage of syndicated programs on distant signals. In June, 1977, the FCC followed this with an inquiry into the economic relationship between television broadcasting and cable television.²

In the spring of 1979, the Commission consolidated the syndicated exclusivity proceedings and the economic inquiry when it issued its *Notice of Proposed Rulemaking*.³ The *Notice* was issued in conjunction with the *Syndicated Exclusivity Report*⁴ and the *Economic Inquiry Report*.⁵

The *Notice* stated that the Commission had historically rationalized its restriction of cable television signals on one of four grounds: (1) to ensure the public against a net loss of television service as a consequence of cable-created audience losses, which would undermine the economic support of television stations, and in the process deprive the poor and those living in areas unserved by cable of video service; (2) as necessary to support the broadcast television station allocations policy with its emphasis on local service; (3) as a means of eliminating what was perceived to be the unfair means by which cable television systems competed with local broadcasters; and (4) as necessary to ensure against injury to the continued production of television programming.

The substance of the *Notice* indicated that the Commis-

¹*Cable Television Report and Order*, 6 FCC 2d 143 (1972).

²*Notice of Inquiry* in Docket 20988, 61 FCC 2d 746 (1976). See also *Notice of Inquiry* in Docket 21284, 65 FCC 2d 9 (1977).

³71 FCC 2d 1004 (1979).

⁴71 FCC 2d 951 (1979).

⁵71 FCC 2d 632 (1979).

FCC Rules And Regulations

sion no longer found such arguments persuasive and that it was leaning heavily toward elimination of distant signal and exclusivity rules. According to the Commission:

"Both reports note the significant sacrifices in consumer welfare occasioned by the distant signal and syndicated exclusivity limits and essentially inquire whether there are benefits which outweigh these costs. As the reports make clear, all available evidence indicates that our rules limiting the quantity and composition of distant broadcast signals carried on cable systems are not only unnecessary, but counter-productive."⁶

The *Economic Inquiry Report* took a similar tack:

"The benefits of our current rules are small and these benefits go mainly to broadcasters whose incomes thereby rise faster than they otherwise would. The costs of our current regulations fall on existing and potential cable subscribers, each of whom is denied some increase in freedom of choice."⁷

The Commission decision

So, early in 1979, the Commission was already favorably disposed to eliminate the distant signal rules. In July 1980, in a 4-3 vote, the FCC did just that. The Commission majority hailed the decision as a victory for consumers. Cable subscribers would benefit greatly, while not harming nonsubscribers. The FCC did acknowledge that some local stations might experience a loss in revenues resulting from elimination of the rules in question. However, it determined that such a loss would likely not translate into a net loss in television service.

The Commission maintained that net profits of TV stations have continued to increase over the past several years, in spite of the large increases in the number of cable TV subscribers and unlimited distant signal importation in the main markets exempted from the 1972 rules. The FCC found that many UHF television stations, particularly independents, *actually experienced revenue and audience gains rather than losses from cable*. This occurred despite high penetration and carriage of multiple distant signals, because of the improved signal reception of UHF when it is carried on a cable system.

Some opponents of free distant signal carriage cited the example of "superstations" and their perceived negative impact on local programming, as well as the financial stability of local stations. The Commission found that the effect of distant signal carriage on the financial health of television broadcasters is small in relation to the normal growth of the industry's financial prosperity. Those audience losses which are attributable to cable have little effect on local television programming.

Moreover, the Commission had noted previously in the *Economic Inquiry Report* that audience diversion would only be important enough to threaten many broadcasters if nearly everyone in a market subscribed to cable and shifted his viewing to new cable services. All available information would suggest that under foreseeable circumstances, cable penetration will not likely exceed about 48 percent of the nation's TV households. But if the shift to cable does occur, "it can only be because cable services are generally regarded as superior by nearly all households — in which case it is difficult to find a public interest rationale for continued protection of over-the-air broadcasters."⁸

In the case of syndicated exclusivity rules, the Com-

mission determined that they had imposed significant costs on subscribers and potential cable TV subscribers. FCC studies had not produced evidence that elimination of those rules would have any effect on the prices paid for programming. Nor would there be any perceptible effect on their supply.

The FCC added that the current syndicated exclusivity rules offer little protection to smaller broadcasters. The most extensive protection is accorded larger market stations, which presumably are in less need of protection from cable competition anyway. Moreover, as chairman Ferris noted in his separate statement, the regulatory protection "is in fact rarely requested by local broadcasters and would, in any event, provide a small scope of security to a relatively limited number of programs even if they were applied."

The Commission decided to avoid altogether the possible addition of retransmission consent to its rules for cable TV. Retransmission consent would involve requiring new cable systems or those adding new signals to receive permission from the originating station before carrying the new signal. The National Telecommunications and Information Administration of the U.S. Department of Commerce had previously requested adoption of such a rule.

The Commission said that such consent was tantamount to full copyright liability, whereby copyright holders would have the final say on what programs could be shown. Congress rejected such a full copyright liability with the adoption of the 1976 Copyright Act. The *Notice* had noted this decision by Congress:

"... Congress was cognizant that a compulsory licensing procedure would exempt cable television operators from the responsibility to negotiate with copyright owners for individual program clearances and that this procedure did not represent a conventional copyright solution, but nevertheless concluded that a compulsory license procedure for cable would best serve the purposes underlying the copyright laws."⁹

The outcrop of the 1976 Copyright Act was the Copyright Royalty Tribunal, which many supporters of retransmission consent deem an insufficient substitute. Nevertheless, the Commission bypassed this issue in the distant signal decision.

Conclusions

Broadcasters and cable operators alike should note that the FCC's decision affects only the distant signal and syndicated exclusivity rules. The Commission did not change the "must carry" rules, the sports black-out rules, and network non-duplication. Cable operators must still provide these protections to local broadcast TV stations.

The effective date of this FCC decision is still unknown. At the time of this writing, the Commission had still not issued the text of its decision. However, Malrite TV of New York requested that the United States Court of Appeals review the Commission decision within hours of the FCC vote. So, this policy will conceivably not take effect until after final disposition by the courts. In the meantime, TV broadcasters should carefully review this decision once the text becomes available. **BM/E**

⁶Notice of Proposed Rulemaking, *supra*, para. 57. Footnote omitted.

⁷Economic Inquiry Report, *supra*, para. 144.

⁸71 FCC 2d 632, para. 142.

⁹Notice of Proposed Rulemaking, *supra*, at para. 100.

VIDEO AIDS from

VAC[®]

VIDEO AIDS[®] of colorado

1930 CENTRAL AVENUE • BOULDER, COLORADO 80301 • PHONE (303) 443-4950

WITH THE NEW DECADE... STARTING OUR SECOND DECADE OF SERVICE TO YOU.

MULTI-PHASE METER/VIRS INSERTER MODEL 4000 \$1500

This unit is both a production tool and engineer's instrument. It can be substituted in place of a vectorscope when measuring VIRS-phase and Burst-phase errors. The Model 4000 is an ideal replacement for most oscilloscopes where H-phase errors need to be observed and measured. In addition to displaying H, Burst, and VIRS phase on lighted meters, VAC's Model 4000 can generate and add VIRS to line 19 of each television field.



BURST PHASE METER

BPM-1 \$650, BPM-1R \$695, Opt 02 \$800, 02R \$845, 03 \$1000
Technicians and engineers alike find the burst phase and H phase (options 02, 02R, 03) meter easier to use, more accurate and convenient, and one-fifth the cost of traditional vectorscopes. The BPM's small size and low-cost make this instrument ideal for recording rooms, TV studios and remote vans.

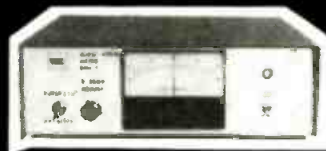

COLOR GENLOCK SYNC GENERATOR MODEL 5000 \$1995

This generator provides three modes: An internal temperature compensated crystal standard that is in spec from a cold start; an automatic mode that provides superior genlocking with digital noise immunity circuits for NTSC sources; and a very wide range helical genlock that is front panel selected to lock to helical recorder playbacks even with $\pm 1\%$ speed variations and 10 microsecond skew.

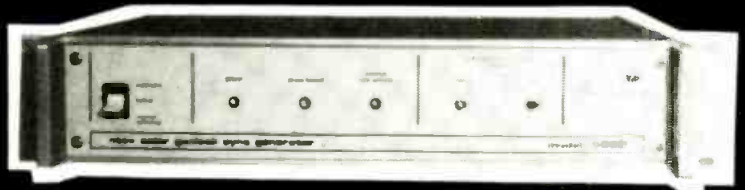

ELECTRO OPTICAL ISOLATORS NEW MODEL 800 \$175, VL-1 \$250

The model 800 converts the latest Sony color TV receivers with push button audio to a high quality color receiver/monitor combination with 80 dB common mode rejection between coax and monitor. The VL-1 video line isolator provides this same 80dB isolation in a self contained unit for eliminating ground loop hum problems. Isolators are still available for older Sonys (specify model number).



PARTY LINE SYSTEM

MODEL PLS-1 \$100, PL-1 \$60

Benefits: Individual volume control
Model PLS-1 handles up to 10 headset units
Low cost
Small cabinet for mounting near camera, etc.

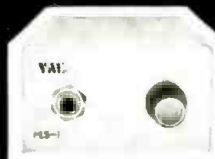

VIDEO DISTRIBUTION AMPLIFIER

MODEL VDA-1P \$125, VDA-1 \$79.50

These DA's are inexpensive units for 12Vdc or 117VAC operation. They have been designed to install in TBC's and other equipment where up to six video outputs are required. Thus, no cabinet is included.

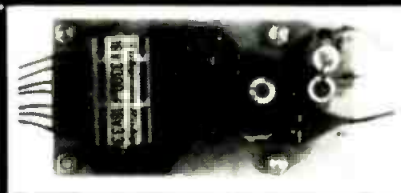

VIDEO ACTIVATED POWER SWITCH

MODEL VPS-1 \$75

Save electrical energy by using monitor only when video is present. Reduce color monitor maintenance when no drives are present. Eliminate distractions from free-running monitors. Eliminate special AC power lines or tall ladders to turn video monitors on and off in special locations.

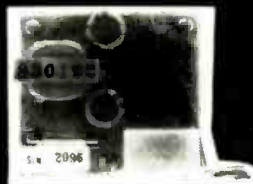

BROADCAST EQUIPMENT

Two-Deck Cart Machine

350

Model DB-2000 is a broadcast-quality two-deck cart machine that can be field-converted from mono to stereo at any time. Additional cue tones can be added to the recorder or reproducer by plug-in circuit cards. Manual fast forward is standard; independent electronics on each deck allows simultaneous record and playback. Regulated 24 V dc is used throughout, including a 24



V air-damped solenoid and servo motor. Construction is modular and deck assemblies are interchangeable between the machines in this series. The machine operates on 105 to 130 V, 50/60 Hz and can be internally strapped for 210 to 260 V operation. Specs include: wow and flutter, 0.15 percent or less peak weighted; timing accuracy, 0.1 percent or better; system distortion, 2.0 percent THD or less; noise 54 dB or better mono, 52 dB or better stereo; crosstalk 50 dB or better at 1 kHz. Frequency response is ± 2 dB from 50 Hz to 15 kHz. D-B ELECTRONICS.

24-Hour Logger

351

SP74 broadcast logging rack requires reloading only once every 24 hours. Based on a four-channel 15/16 ips version of the maker's SP7 open-reel recorder, the two-machine logger provides four continuous recording channels, assigned in a typical AM/FM station to two stereo FM channels, one

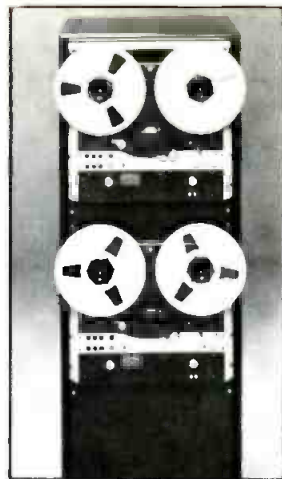

AM channel, and one time code channel. Each channel has its own balanced line input with level control. A single balanced output is switchable to any of the four channels, with tape/source switching and metering of the selected channel. Each channel also has its own bias set and output level control. The logging rack provides automatic changeover from one recorder to another in the event of tape breakage or stoppage, and within 15 minutes from the end of the tape. The system comes in a six foot standard EIA rack and can be supplied with digital clock, monitor amp, and loudspeaker. NEAL FERROGRAPH U.S.A.

POWER TUBES REBUILT

2 KW to 200 KW
ECONCO BROADCAST SERVICE

Let Econco rebuild your transmitter power tubes

- Price typically 1/2 the cost of new tubes
- Warranty 400 hours unconditional - 4000 hours pro-rata
- 3500+ satisfied customers throughout the world
- 40,000 + power tubes rebuilt since 1968



For more information call or write

ECONCO BROADCAST SERVICE

1302 Commerce Ave. Woodland, CA 95695
(916) 662-4495 or (916) 662-6031.

Circle 260 on Reader Service Card

Zepplin[®] wind screen



Z416 - \$115.00
Z816 - \$130.00
AR416 - \$70.00
AR816 - \$75.00

The Zepplin Wind Screen insures rumble-free sound recording under windy conditions. Your video recorded sound will be virtually studio-clean despite noisy air movement. The Zepplin's aerodynamic design screens the microphone, filtering the wind, allowing the sound in. Although extremely lightweight, the Zepplin is nearly indestructible and can be boom mounted or hand held with the Independent Suspension Shock Mount. There are Zepplins available to house Sennheiser 816 and 416, AKG CK-8 and CK-9 and other similar microphones.

alan gordon enterprises inc.

1430 N. Cahuenga Blvd., Hollywood, CA 90028
Telephone: (213) 486-3561 • (213) 905-5500
TWX: 910-321-4836 • Cable: GORDENT

Circle 262 on Reader Service Card

1" VTR to go

Rent Hitachi's HR-100 VTR from Miller.
It's lighter than you think.

Lighter on you

Pick up Hitachi's new HR 100. You'll be surprised so much 1" video recording reliability (meets SMPTE Type C standards) can be packed so compactly and weigh so little (less than 42 lbs.) Rugged enough for location

ENG/EFP use; low-power consumption, includes automatic assemble-edit, video confidence, built-in time code generator.

Lighter on your budget

Find out how little it costs to rent a new Hitachi HR 100 from Miller — the video specialists.



L. MATTHEW MILLER Assoc. Ltd.

Suite 1316, 205 East 42nd Street, New York, NY 10017
Telephone: (212) 687-1168 • (800) 223-0620. Cable VIDEOUSA Telex 238917

VIDEO EQUIPMENT • RENTALS • SERVICE/REPAIRS • VIDEOTAPE • EDITING



Circle 261 on Reader Service Card

Music Scheduling System 352

This automated system, coordinated around the maker's Chieftain micro-computer, uses input from station music research to provide computerized analysis of the target audience's song preferences. It can also provide quarter-hour reports on when each demographic segment of the overall audience target is available to listen each day of the week. The floppy disc-based system, including video terminal and printer, is fully integrated for immediate access and analysis of data. It is programmed in BASIC, which requires no previous computer experience to learn. \$10,000 to \$20,000 depending on options. SMOKE SIGNAL BROADCASTING.

Remote Audio System 353

The Lines-Plus remote broadcast audio system, incorporating a portable transmitter and rack-mounted receiver, is described by the maker as a complete communications system. It requires the use of two telephone lines (normal dial lines are adequate) and provides a frequency response of 50 to 5000 Hz with narrow cut at 2500 Hz. Other features

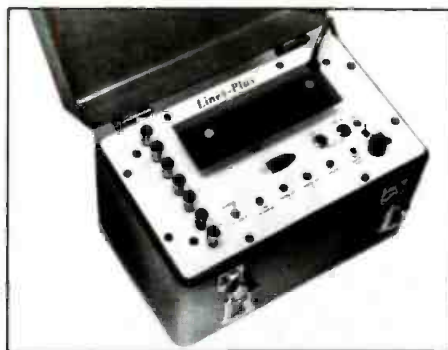

include two-way signalling for cuing or other slow speed data and greatly improved line reliability resulting from patented and patent-pending circuitry. The transmitter unit weighs about 10 pounds. KAHN COMMUNICATIONS.

Audio Delay 354

The Memory Module, when interfaced with the manufacturer's DL-2 Acousticcomputer[®] and DL-4 Time Line[™], allows an additional two seconds of delay with no degradation in performance.

**For more information
circle bold face numbers
on reader service card.**

Units may be cascaded to obtain additional seconds of delay, again with no degradation in the performance of the master unit or the Memory Module, according to the manufacturer. DELTA-LAB RESEARCH.

Control & Status Panel 355

The CSP-1600 party line control and status panel is designed to control AVS-1 series routing switcher matrices. Its four-character alphanumeric displays permit operators to address sources by their familiar names without

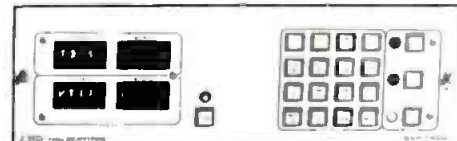

having to mentally correlate display numbers with group names. Up to 100 units may be assigned to each of the 16 groups, providing up to 1600 name/number combinations. Other features are separate PRESET and ACTIVE displays for both video and audio and four switching modes: audio only, video only, AFV, and audio/video split. Available in 3½-inch rackmount and recessed mounting configurations. UTAH SCIENTIFIC.

Lightweight and comfortable

headsets

- Independently wired phones
- Intercom and Sportscaster Applications

Literature on request from
Television Equipment Associates, Inc.
Box 260, South Salem, N.Y. 10590
Tel: 914-763-8893
TWX: 710-575-2600

Circle 263 on Reader Service Card

DITTY DESK

**THE DITTY DESK IS
5 CHANNEL ECONOMY
FOR PRODUCTION OR
REMOTES
STEREO \$2495 —**

CALL YOUR DEALER OR 413 536-3551

MICRO-TRAK CORPORATION

620 RACE ST. HOLYOKE, MASSACHUSETTS 01040

Circle 264 on Reader Service Card

When accuracy Counts...Count on Belar for AM/FM/TV MONITORS

BELAR
AM MODULATION MONITOR

BELAR CALL ARNO MEYER (215) 687-5550 ELECTRONICS LABORATORY, INC.

LANCASTER AVENUE AT OORSET, DEVON, PA. 19333 • BOX 826 • (215) 687-5550

Circle 265 on Reader Service Card

Broadcast Equipment

Portable Audio Console 356

Model BC-1 is a portable broadcast audio console designed for field production. Powered with an external power supply or optional Ni-cad battery pack, the mixer is available with eight to 32 inputs in a modular input channel configuration. This expandable main-

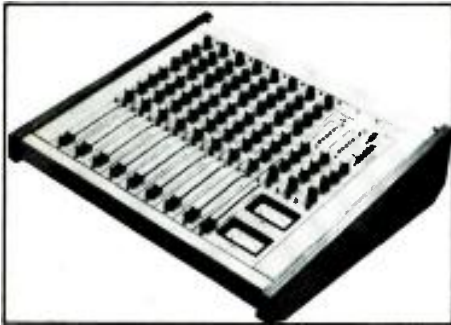

frame design features three-band EQ, three sends, Penny & Giles conductive plastic faders, fully balanced inputs and outputs, PFL/mute, and flexible monitoring on each input. A switchable LED PPM meter and analog VU or PPM meters are provided on the stereo output module, as is a built-in headphone amp. Options include RTS inter-

com talkback, IFB systems, down-cue switching, and various configurations of ITA flight cases or leather carrying cases with shoulder straps. From \$5400. TANGENT SYSTEMS.

Rack-Mount Cases 357

The Shock-Mount case, latest in the manufacturer's line of rack-mount cases for broadcast equipment, is described as the industry's first true shock-isolation travel case. Two layers of top-grade plywood sidewalls are separated by a two-inch cushion of

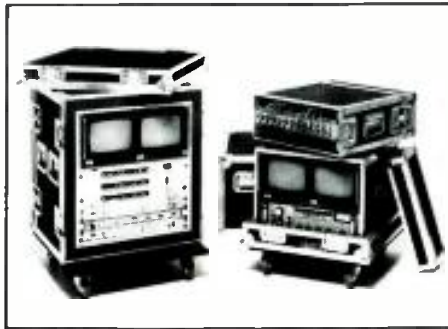

high-density polyfoam. The standard front and rear clamp-on lid design is available in heights ranging from 3½ inches to four feet or more. The pull-over clamp-lid type features a removable inner rack-frame. ANVIL CASES.

Camera Lights 358

Models FL-250 and FL-100 are two new 14-ounce Frezzi-Lite™ camera lights for television broadcast and film use. FL-250 features a smoothly ad-



justable thumbwheel focusing light and choice of 150 W, 250 W, or 350 W tungsten-halogen 30 V 3400 K bulb. Other features include an optional removable "swing-away" dichroic filter and a permanently attached five-foot long cable that terminates in a standard Amphenol two-pin female plug. FL-100 is similar but has a 100 W 11.5 V lamp; its cable termination is a three-pin plug. Both are powered by the maker's hand-carried or belt-style battery packs. FREZZOLINI ELECTRONICS.

Welcome Back!

The only full octave, 2 memory, oscilloscope output, spectrum display.



Applied Technology Corporation
27106 46th South, Kent, WA 98031 (206) 854-4486

Circle 266 on Reader Service Card

SA-100 SAFE AREA GENERATORS



Ensure correct positioning every time of graphics and other pertinent picture information, regardless of monitor scan or centering.

Safe Area pattern is generated and keyed into the video signal fed to the SA-100 input (normally the output of the switcher Preview Buss.)

The remote panel included with the SA-100 provides switching for: Safe Action, Safe Title, Center Cross, Black/White, On/Off.

broadcast video systems ltd.

1050 McNicoll Ave.
Agincourt, Ont. M1W 2L8
(416) 497-1020

Circle 268 on Reader Service Card

COLOR SLOW-MOTION DISC RECORDER

600 ELECTRONIC SLIDES
SPORTS • ANIMATION

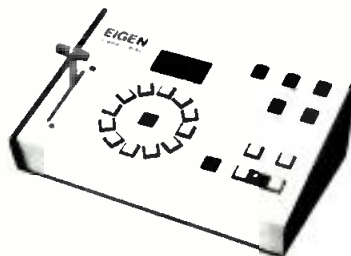

for full specifications & pricing:

EiGEN VIDEO

Phone: 916/273-1341
P.O. Box 1027, Grass Valley, CA 95945

Circle 267 on Reader Service Card

Production Switcher

359

Model 250 P/N is a PAL/NTSC production switcher for TV studio, production, and remote control unit use. Self-contained and easy to operate, it measures 19 by 12¼ by six inches. The switcher offers 10 inputs, five video levels, three keying levels, 32-pattern

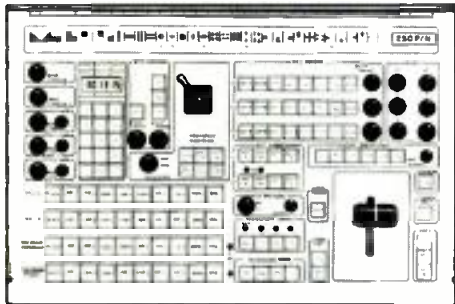

generator, complete camera tally and non-sync input system, camera monitor output, and many other standard features. Options include editor access and SqueeZoom interface. VITAL INDUSTRIES.

Audio Computer

360

Badap I is designed to perform a wide array of audio test functions. Because it is programmable, new functions require no new hardware, but only a change in programming. Existing software includes programs for real-time analysis and 1/3-octave analysis, RT60 (reverberation time), acoustic distance measurement, and chromatic spectral decay. Accessories include a stereo analyzer and an input multiplexer.

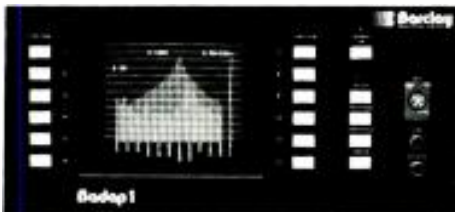

Among the planned future programs are a 64-channel multiplexer, disc tracker, harmonic and IM distortion analysis, a stereo broadcast modulation monitor, digital logic analysis, digital filtering, wow/flutter spectral analysis, and many others. The unit can display up to eight data sequences at one time via a system of bars or dots and four NTSC-compatible colors. Data can be stored and recalled later for comparison with real-time data. Because all software is on circuit boards, users can add any new function as it becomes available. CROWN INTERNATIONAL.

Prompting System

Camraprompter is a low-cost, lightweight film/video camera prompting



system. A clear acrylic optical flat, set at a 45-degree angle in front of the camera lens, acts as a mirror reflecting the bright, easy-to-read script to the subject being photographed. There is virtually no light loss to the lens, according to the manufacturer. The script "scroll" is backlit with a side-mounted light source. Script copy can be typed or

hand-printed onto the matte-finish clear plastic 25-foot roll, which is advanced by a quiet, miniaturized motor drive. A remote control unit provides continuously variable speed control in forward and reverse. The system is powered by a standard 12 V battery pack or belt. \$1800. CINEMA PRODUCTS CORP., 2037 Granville Ave., Los Angeles, Calif. 90025.

**For more information
circle bold face numbers
on reader service card.**

"While others may fit the station to the format...

BPI fits the format to the station."

David F. Lindsay
Program Consultant

As the original music syndicators, BPI has more formats than anyone else, so we're sure to have one for you. What's more, we customize. Make it personally yours. After all, it's **your** station. Call for further details. No obligation. **Toll free: 1-800-426-9082**

BPI Broadcast Programming International, Inc.
Box 2027 • Bellevue, WA 98009 • (206) 454-5010

BPI
MUSIC IS

Circle 269 on Reader Service Card

Underwater Video

Try a wet "point of view" with an Ocean Realm/Sony BVP-300 "all environmental" system. Great for water sports and harsh condition EFP. Let our cameras get wet while yours stay dry! For more information call: 305/573-2767 or write. . .

**Ocean
Realm** SYSTEMS

Box 370293-B • Miami, FL 33137

Circle 270 on Reader Service Card

MARK 200 VHF Full-Duplex Communicator



COMMUNICATOR FEATURES

- Compatible with many hard wire PL systems including RCA, RTS, Clear-Com, etc.
- True Hands Off Operation
- One-half mile usable range, typical
- Push To Talk for system expansion
- Data information input
- Compatible with many popular headsets including PLANTRONICS M550, BEYER DT109, SHURE SM12, ROANWELL, ASTROLITE, MINILITE, TELEX, etc.
- Dimensions and Weight 7.5" L x 4.7" W x 1.9" D, 2 lbs.
- Fast change "SNAP IN" NICAD battery pack
- A MARK 200 System consists of two MARK 200 transceivers, antennas, batteries and carrying case, headsets

Swintek Wireless Microphones • Full Duplex Communicators • Antenna Systems

1180 Aster Avenue, Unit J, Sunnyvale, CA 94086 (408) 249-5594

Circle 271 on Reader Service Card

BM/E SEPTEMBER, 1980 201

ADVERTISERS INDEX

ADDA Corp.	3
ADM Technology, Inc.	9
Alexander Manufacturing Co.	112
Allen Avionics Inc.	145
American Data Corp.	24
Amperex Electronics Corp.	36-37
Ampex Corp.	16-17,46
Ampro/Scully	51
Anton/Bauer Inc.	93
Anvil Cases Inc.	84
Applied Technology Corp.	200
Aristocart	168
Arvin Echo	139
Asaca Corp. of America	59
Audio & Design (Recording) Ltd.	130
Auditronics Inc.	97
Beaveronics	161
Belar Electronics Lab. Inc.	199
Bell Helicopter Textron	128
Beyer Dynamics	194
Bogner	142
Bonneville Productions	96
BPI	201
Broadcast Controls	148
Broadcast Video Systems	200
BSM	150
BTX Corp.	176
California Microwave	134
Camera Mart, Inc.	129
Canon USA Inc.	158
Capitol Magnetic Products	122
Central Dynamics Ltd.	111
Cetec Corp.	76
Cezar International Ltd.	138
Christle Electric Corp.	50
Chyron Corp.	25
Cine 60 Inc.	113
Cinema Products Corp.	192
Clear-Com Intercom Systems	146
CMC Technology	19
CMX/Orox	22-23
Compact Video Systems, Inc.	162
Comprehensive Video Supply Corp.	95
Comrex	18
Conrac Corp.	136
Continental Electronics Mfg. Co.	105
Convergence Corp.	91
Crosspoint Latch Corp.	131
CSI Electronics Inc.	193
Datametrics Inc.	178
Datatek Corp.	179
Datatron	74
Dictaphone Corp.	137
dbx Professional Sound	99
Delta Electronics	115
DI-Tech	171
Victor Duncan	149
Eastman Kodak Co.	87
Econco Broadcast Service Inc.	198
EECO	35
EG&G	104
EEV Inc.	69
Eigen Video	200
Elmac	38
Eicom Specialty Products	152
Electro Impulse	177
Electro-Voice	10
EMS	141
E-N-G Corp.	202
ESE	183
Eumig, USA Inc.	185
Yves Faroudja Labs Inc.	147
Fernseh Inc.	44-45,119
Fidelipac	109

Frezzolini Electronics Inc.	132
Fujinon Optical Inc.	181
Fuji Photo Film U.S.A. Inc.	67
General Electric Co. Video Display Equipment	40
Global Communications	126
Alan Gordon Enterprises Inc.	198
Gorman-Redlich Mfg. Inc.	175
Grass Valley Group, Inc.	7,106
Gray Engineering Corp.	180
Hallikainen & Friends	140
Harris Corp.	12,32,127
Hitachi Denshi American Ltd.	4-5
Ikegami Electronics USA Inc.	15,143
Industrial Sciences Inc.	83
Inovonics Inc.	124
International Tapetronics Corp.	103
U.S. JVC Corp.	70-71
Knox Video Systems	98
Laird Telemedia Inc.	173
Lemo USA, Inc.	175
Lenco Inc.	133
Lightning Elimination Assoc.	100
Listec Television Equip. Corp.	186
Lowel Light Inc.	92
LPB Inc.	170
3M/Magnetic Tape Div.	64
3M/Mincom-Video Products	56,117
Magna-Tech Electronic Co., Inc.	174
Marconi Electronics Inc.	79
Marconi Instruments	120
McCurdy Radio Ind.	C3
MCI, Inc.	173,180
MCI/Quantel (Micro Consultants Inc.)	101
Merlin Engineering	118
Micro-Trak Corp.	199
Microtime Inc.	156
L. Matthew Miller	198
Modular Audio Products	90
Monroe Electronics — O'Brien	14
Moseley Assoc. Inc.	188
Neal Ferrograph	116
NEC America, Inc.	81
Rupert Neve Inc.	11
Nudd Corp.	178
Ocean Realm Systems	201
Oki Electric Industry Ltd.	54
Orban Associates Inc.	187
Otari Corp.	63
Pacific Recorders & Engineering Corp.	140
Panasonic — Matsushita	C2
Phelps Dodge Communications Co.	190
Philadelphia Resins Corp.	94
Phillips Broadcast Equipment Corp.	48
Potomac Instruments	145
QEI Corp.	148
Ramko Research	28-29,154-155
RCA Broadcast Systems	30
Recortec	167
Rockwell International	43
Rohde & Schwarz	13,184
Jos. Schneider GmbH Co.	182
Shintron	177
Shure Bros. Inc.	189
Sintronic Corp.	169
Skotel Corp.	108
Stainless Inc.	110
Stanton Magnetics Inc.	153
Storeel	121
Studer Revox America Inc.	89
Swintek	201
System Concepts	107

Telecommunications Industries Ltd.	142
Telemet	165
Television Equipment Assoc.	148,186,199
Television Technology	186
Telex Communications Inc.	135
Tentel	21
Thomson — CSF Broadcast	61
Time & Frequency Technology Inc.	151
UMC Electronics Co.	150
United Media	114
Utah Scientific Inc.	102
Valtec Corp.	123,125
Video Aids Corp. of Colorado	197
Video Data Systems	27
Videotek, Inc.	146
Viscount Industries Ltd.	152
Vision-Sound Professional Audio, Inc.	144
Vital Industries Inc.	172
Ward-Beck Systems Ltd.	C4
Weathermatic Inc.	72
Yardney Electric Corp.	150

SALES OFFICES



Broadcast Management/Engineering

295 Madison Ave.
New York, New York 10017
Telex: 64-4001

Eastern & Midwestern States

295 Madison Avenue
New York, New York 10017
212-685-5320
James C. Maywalt
Denis J. O'Malley

Western States

353 Sacramento Street
Suite 600
San Francisco, CA 94111
415-421-7330
William J. Healey
3420 Ocean Park Blvd., Suite 3020
Santa Monica, CA 90405
213-450-7181
Bob Hubbard

United Kingdom/Europe

Chilberton House
Doods Road
Reigate, Surrey, England
Telephone: Reigate 43521
Robert N. Burn
Bronwyn Hoimes
Derek Hopkins

Japan/Far East

Eiraku Building
1-13-9, Ginza,
Chuo-Ku, Tokyo 104 Japan
03 (562) 4781
S. Yasui
K. Yamamoto

MOBILE ELECTRONIC JOURNALISM

FIELD TESTED VANS AND FOUR
WHEEL DRIVE DESIGNS TO MEET
YOUR ENG/EFP REQUIREMENTS.
QUALITY • RELIABILITY • ECONOMY

E-N-G CORPORATION

1009C SHARY CIRCLE • CONCORD, CA. 94518
(415) 798-4060



Circle 272 on Reader Service Card

SS8800

The SS8800, a compact, fully modular, desk mounting stereo console which provides full broadcast facilities in a functionally styled package utilizing professional quality circuitry of proven reliability. The 8 mixer version being available for the unusually attractive price of \$9,500, with a 16 mixer version available soon.

The SS8800 is fully systems compatible and incorporates all the features expected in a modern console and normally unavailable in a unit of such compact dimensions. It is available with a full range of pre-wired options and as an integral part of complete packaged systems custom tailored to your requirements.



McCURDY RADIO INDUSTRIES

TORONTO
(416)751-6262

CHICAGO
(312) 640-7077

In Our 4th Decade of Service To The Broadcast Industry

SS8550 STEREO CONSOLE



AM ON AIR STUDIO, WJR DETROIT

ONE OF FOUR STUDIOS FOR AM AND FM RADIO
UTILIZING SS8550 STEREO CONSOLES,
CUSTOM DESIGNED TO THE SPECIFICATIONS OF
CHIEF ENGINEER, JOHN BEGIN

McCURDY RADIO INDUSTRIES
TORONTO • CHICAGO
(416) 751-6262 (312) 640-7077

Circle 173 on Reader Service Card



SS8650

The SS8650, a standard, fully modular 16 mixer stereo console offering full facilities, quality circuitry of proven reliability, comprehensive features and a range of standard pre-wired options. A centrally-located script board is supplied along with a range of input and accessory modules to suit any requirement. Standardization allows all these features to be incorporated in a well-engineered, attractively styled free-standing package at an economical price.

The SS8650 can be custom engineered to suit your specific requirements and as an integral part of complete packaged systems.



100 Huntley Street

100 Huntley Street, known to millions of television viewers across North America, Europe and the Far East, is both the title of a daily program series and the location of a dynamic production centre operated by Crossroads Christian Communications Inc. Network and syndicated programs in ten different languages are produced and mixed here in newly expanded facilities that include this comprehensive custom Ward-Beck model 790637 television audio control console.



First by Design.

Ward-Beck Systems Ltd., 841 Progress Avenue, Scarborough, Ontario, Canada M1H 2X4.
Tel:(416)438-6550.

Ward-Beck Systems Inc., 6900 East Camelback Road, Suite 1010, Scottsdale, Arizona 85251.